

BULLETIN
OF
THE BINGHAM OCEANOGRAPHIC COLLECTION
Volume 15
Oceanography of Long Island Sound, 1952-1954
Issued February 1956

published by
Peabody Museum of Natural History
Yale University
New Haven, Connecticut, USA
www.peabody.yale.edu

Contents

- Harry Payne Bingham 1887–1955, pp. 4–8
I. Introduction, Gordon A. Riley, pp. 9–14
II. Physical Oceanography, Gordon A. Riley, pp. 15–46
III. Chemical Oceanography, Gordon A. Riley and Shirley A. M. Conover, pp. 47–61
IV. Phytoplankton, Shirley A. M. Conover, pp. 62–112
V. Zooplankton, Georgiana B. Deevey, pp. 113–155
VI. Biology of *Acartia clausi* and *A. tonsa*, Robert J. Conover, pp. 156–233
VII. Pelagic Fish Eggs and Larvae, Sarah B. Wheatland, pp. 234–314
VIII. Chemical Composition of the Plankton, Eugene Harris and Gordon A. Riley, pp. 315–323
IX. Production and Utilization of Organic Matter, Gordon A. Riley, pp. 324–344
X. Biology of Marine Bottom Communities, Howard L. Sanders, pp. 345–414
Publications issued by the Bingham Oceanographic Laboratory, pp. 415–419



Yale University

© Peabody Museum of Natural History, Yale University. All rights reserved.

Made available courtesy of the Long Island Research Center and the Yale Peabody Museum.

BULLETIN
OF
THE BINGHAM OCEANOGRAPHIC COLLECTION
PEABODY MUSEUM OF NATURAL HISTORY
YALE UNIVERSITY

VOLUME XV

OCEANOGRAPHY OF
LONG ISLAND SOUND, 1952-1954

By

GORDON A. RILEY
SHIRLEY A. M. CONOVER
GEORGIANA B. DEEVEY
ROBERT J. CONOVER
SARAH B. WHEATLAND
EUGENE HARRIS
HOWARD L. SANDERS

Issued February, 1956
New Haven, Conn., U. S. A.

Env-ocean
~~1901~~
802

OCEANOGRAPHY OF
LONG ISLAND SOUND, 1952-1954¹

By

GORDON A. RILEY
SHIRLEY A. M. CONOVER
GEORGIANA B. DEEVEY
ROBERT J. CONOVER
SARAH B. WHEATLAND
EUGENE HARRIS
HOWARD L. SANDERS

VOLUME XV

BULLETIN

OF

THE BINGHAM OCEANOGRAPHIC COLLECTION
PEABODY MUSEUM OF NATURAL HISTORY
YALE UNIVERSITY

Issued February, 1956
New Haven, Conn., U. S. A.

¹ These studies were aided by a contract between the Office of Naval Research, Department of the Navy, and Yale University; reproduction in whole or in part is permitted for any purpose of the United States government.

THE I

RY

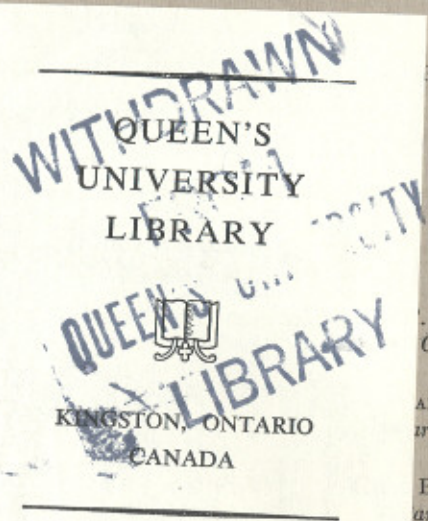

YNGVE H. OLSEN
Managing Editor

GRACE E. PICKFORD
Research Associate

JULIANNE HALL
Secretary

PATRICK
Technician

G. THOMPSON
Curator

ANA B. DEEVEY
Arch Assistant

B. WHEATLAND
ant in Research

RICH
Technician

HONORARY ASSOCIATES

C. M. BREDER, JR.
*American Museum
of Natural History*

A. E. PARR
*American Museum
of Natural History*

SCIENTIFIC CONSULTANTS

WERNER BERGMANN
*Sterling Chemistry Laboratory
Yale University*

G. E. HUTCHINSON
*Osborn Zoological Laboratory
Yale University*

VICTOR L. LOOSANOFF
*Milford Laboratory
U. S. Fish and Wildlife Service*

R. F. NIGRELLI
*N. Y. Zoological Society
Bronx Park, New York*

QL 121. A1 Y1 v.15 1956
cop. 2

19856

Part

CONTENTS

	<i>Page</i>
HARRY PAYNE FINGHAM, 1887-1955	5
G. A. RILEY: I. Introduction	9
G. A. RILEY: II. Physical Oceanography	15
G. A. RILEY AND S. A. M. CONOVER: III. Chemical Oceanography	47
S. A. M. CONOVER: IV. Phytoplankton	62
G. B. DEEVEY: V. Zooplankton	113
R. J. CONOVER: VI. Biology of <i>Acartia clausi</i> and <i>A. tonsa</i>	156
S. B. WHEATLAND: VII. Pelagic Fish Eggs and Larvae	234
EUGENE HARRIS AND G. A. RILEY: VIII. Chemical Composition of the Plankton	315
G. A. RILEY: IX. Production and Utilization of Organic Matter	324
H. L. SANDERS: X. The Biology of Marine Bottom Communities	345



HARRY PAYNE BINGHAM

YALE '10

HARRY PAYNE BINGHAM

1887-1955

Harry Payne Bingham died in Palm Beach, Florida on March 25, 1955—twenty-five years almost to the day after his original endowment of the Bingham Oceanographic Laboratory at Yale University.

Bingham was born in Cleveland, Ohio on December 9, 1887. He received his formal education at the Taft School and at Yale, where he was a prominent athlete, participating in football (varsity Y), hockey, baseball and golf, and where he roomed with Adrian Van Sinderen and the late Senator Robert A. Taft. He returned to Cleveland after graduation and became associated with the Upson Nut Company, manufacturers in steel and iron.

In the fall of 1916, on the eve of our entry into World War I, Bingham wrote, "My plans are to go to the military camp at Plattsburg, and to do all I can to elect Hughes." He was secretary of the General Munitions Board and the War Industries Board in Washington from March to December 1917. Commissioned a First Lieutenant of Ordnance, he was later transferred to the 4th Field Artillery Brigade, serving as its operations officer and taking part in the Chateau-Thierry, St.-Mihiel, and Argonne campaigns. He was promoted to Captain in October 1918 and was discharged in March 1919. Following the war he moved to New York, where he became associated with various corporations.

It is difficult to determine what first aroused Bingham's interest in marine biology. For the *History of the Class of 1910, Yale College* (Vol. III, 1926) he wrote: "Since 1923 I have devoted my time largely to scientific research work connected with marine life, and have added some few facts to the science of Ichthyology. I make yearly trips to southern waters in boats especially equipped for deep-sea fishing as well as with all necessary equipment for surface fishing. The specimens I am accumulating in a private museum for further study and reference." And the editor of Volume IV (1935) writes about Bingham: "When he first became active in this field, it was not with the mere intention of establishing a private collection of marine curios, but in the much broader scheme of sponsoring a program of scientific research into the life and natural laws of the sea. For this

purpose three separate oceanographic expeditions were planned, equipped and conducted under Bingham's personal supervision and leadership on his yachts, the *Pawnee I* and the *Pawnee II*, which had been specially fitted with the apparatus necessary for deep-sea work. During the first and third expeditions, in 1925 and 1927, the marine life, particularly that of the relatively unexplored great depths, in the Caribbean and Bahamian waters was investigated. The second expedition, in 1926, worked chiefly in the Gulf of California, from which a wealth of new material was also obtained. To analyze and preserve the scientific results of these explorations, a staff of scientists, artists, and technicians was engaged and given a free hand with the valuable collections. When the results of these studies began to become available, Bingham also arranged for their publication in a scientific series which continues to date, and which, while still under Bingham's private sponsorship alone, was immediately accepted in exchange by all the leading institutions in this field in the world. When, in 1930, he gave to Yale the Bingham Oceanographic Collection, it was therefore not only a gift of a rare and valuable collection of more than 3,000 items, among which nearly 200 species have been found to be entirely new to science, it was also a going concern in marine research and publication. And to provide for its continuation he established the Bingham Oceanographic Foundation."

One of the early members of Bingham's staff was a young Norwegian, Albert Eide Parr, of whom the *New Yorker* (July 18, 1942, p. 10) wrote at the time he became Director of the American Museum of Natural History: "In 1926 he came to this country to find wider opportunities. These opened up dimly at the Aquarium, where he got a job at \$110 a month cleaning spittoons, feeding fish, and washing the windows. A year or so later Harry Payne Bingham put him in charge of the collection at New Haven." Over the years Parr and Bingham became close friends, each admiring the other's particular talents and abilities. Their correspondence in the 1930's, when Parr was Director of the new laboratory at Yale, shows that they remained on formal terms; it was always "Dear Mr. Bingham" and "Dear Parr." But there is an intimacy in the letters themselves which belies the salutations. Thus Parr wrote to Bingham on March 29, 1930 about the moving of equipment from "Tebo's" yacht-yard to New Haven:

I am very sorry that the moving proved to be such an expensive affair, but after having seen what it meant I am convinced that the price was quite decent nevertheless. They started loading in the morning with 6 men, got 8 men in the afternoon and were not through until after seven at night. It was just like opening a warm soda bottle, it seemed to grow and flow out endlessly. It was, incidentally, a quite entertaining undertaking. They had, for instance, been carrying out the smaller nets and came to our 300 feet seine, not knowing what it was, and began loading it on the strongest man, who highhandedly refused any weaker assistance—in the beginning. When he had got about 50 feet on another man had to take up position behind him. Nobody knew how long it was to the end, and it developed into a conjurers' show accompanied by some of the most assorted swearing I have ever listened to. When the net finally came out all eight men were under it, providing great entertainment for the entire building, particularly the strong man, who had wanted to carry it alone. Then there was a youth who innocently wanted to tip a loose coil of steel rope on to his hand truck to wheel it out to the elevator. His arms almost left his shoulders, and his face assumed its most puzzled expression. After four men had tipped, not lifted, the peaceful looking coil onto the truck it was decided that it weighed around 1000 pounds. This was the way it went. Then one truck broke down under the weight before starting from New York the next morning, a reloading had to be done, and they were not through unloading it here until after eight that night.

To this Bingham replied in part:

Your very amusing letter about the moving to New Haven was much enjoyed. I should love to have been there and seen the fun.

In 1950 the *History of the Class of 1910, Yale College* quotes Mr. Bingham as follows: "I have kept a continuing interest in the Bingham Oceanographic Laboratory, which has been given favorable support by the university." The author of the class history goes on to write: "The foregoing modest statement hardly tells the story. The laboratory was started by Bingham twenty years ago. It now has an international reputation. Two important oceanographic journals are published from its offices, and the researches of its staff on the biology and physics of the sea have attracted wide attention. In the last decade the laboratory has also attracted top flight graduate students. From a small beginning it has given the University prominence in a subject of increasing importance, and Yale takes great pride in Bingham's Oceanographic Laboratory."

Research is the primary business of the laboratory, and one measure of its productivity is the output of scientific papers. With this issue the Bulletin of the Bingham Oceanographic Collection has

published since its inception nearly 6,000 pages, and in the past ten years the papers published by the staff in journals outside the Bulletin number 132 and cover 1,360 pages. The laboratory has more than lived up to its original statement of intent, "Founded for the purpose of oceanographic research."

Mr. Bingham's generosity to his university was by no means confined to things oceanographic. On February 22, 1926, President Angell announced to the graduates assembled for Alumni Day a gift of \$1,000,000 made in honor of Mr. Bingham's father by the four children of Charles W. Bingham, '68. From this fund Bingham Hall on the Old Campus was built, the balance of the gift being held for maintenance and general endowment. Mr. Bingham's more recent benefactions to Yale included major contributions to the new Art Gallery and Design Center.

Mr. Bingham seldom visited "his" laboratory at Yale. Yet, when asked, and only if he thought it right, he gave extras: a new truck, the cost of another Bingham Bulletin, even salaries under certain circumstances. When he did come to New Haven, he brought with him warmth, infectious enthusiasm, an inquisitive probing mind, and thoughtfulness. On his last visit to the laboratory in May 1954 he quite characteristically arrived earlier than anticipated. Finding no one available in the front offices, he made his way to one of the younger staff members. "I'm Bingham of the Bingham Laboratory," he said. "What are you working at?" "At the moment I'm describing a new species of fish," came the answer, and Mr. Bingham was instantly fascinated; he asked incisive questions and was as eager as if he had collected the specimen himself. On this occasion, as on all others when he came to New Haven, for each of us who saw him it was a joy.

It is of considerable interest, I think, that Bingham's fascination for the sea preceded by some years the great burst of oceanographic activity which characterized the late '20's and early '30's in this country. His understanding of the contribution to scientific progress that a generously supported though small laboratory could make in the broad field of oceanographic research, as well as his unflinching interest in *results* through a quarter of a century, were characteristic of the man.

Our gratitude to him knows no bounds, and in that spirit this volume is dedicated to his memory.—D. M.

OCEANOGRAPHY OF LONG ISLAND SOUND, 1952-1954

I. INTRODUCTION

BY

GORDON A. RILEY

Bingham Oceanographic Laboratory

During the last fifteen years, the Bingham Oceanographic Laboratory has examined and reported on various aspects of the local waters off southern New England. Riley (1941) described the plankton and associated chemical oceanographic factors in a small area in the north-central part of Long Island Sound. A study of Block Island Sound from 1943 to 1946 and again in 1949 resulted in papers on the fish population (Merriman and Warfel, 1948, and others) fish eggs and larvae (Merriman and Sclar, 1952), benthic fauna (Smith, 1950), and plankton (Deevey, 1952a, 1952b; Riley, 1952b). The 1949 survey, together with observations obtained by the Woods Hole Oceanographic Institution in 1946, supplied data for an analysis of the physical oceanography of the Long Island and Block Island Sounds (Riley, 1952a).

The region as a whole provides a variety of environments ranging from open coastal waters to shallow, protected bays and sounds with markedly reduced salinity. The plankton concentration in these protected waters averages perhaps an order of magnitude larger than those in exposed seaward areas, although the species composition is relatively limited. The quantity of bottom fauna is also large, and shellfish are commercially important. In Block Island Sound and the outer coastal region, commercial interests are primarily centered in the fin fisheries.

It is one of the long term aims of the Bingham Laboratory to accumulate detailed descriptive information on the populations and environmental characteristics of several representative localities within this region and to explain the ecological reasons for observed differences. The region poses a vast number of ecological questions, and the answers, many of which are perceived dimly if at all at the

present time, are of general interest because the region is similar in its broad oceanographic aspects to many other temperate coastal waters.

To list a few of the most general questions: Do the shallow, protected areas produce more phytoplankton than the open waters? Superficially this appears to be so, considering the comparative size of the standing crops, but the latter could be affected drastically by differences in the rate of removal by feeding or physical dissipation. Are there regional differences in the efficiency of transformation of phytoplankton into animal tissue? What makes one area different from another with respect to the kinds of large and commercially useful animals that are produced? What can be learned from a broad and intensive oceanographic survey that will throw light on the problem of annual fluctuations of fish production and the so-called "optimum catch"?

What is the role of freshwater drainage? How damaging are pollution effects? Does land drainage enrich the coastal area, or is this effect insignificant compared with the transport of nutrients by physical oceanographic processes? What effect do silt and bottom sediments have on the transparency of the water and how seriously do they influence phytoplankton production and animal behavior?

The answers to such questions can be obtained only by a long term program of broad scope. They are ultimate rather than immediate problems, and only a few partial answers will be found in the papers that follow. However, these and similar questions need to be borne in mind if the investigation of the moment is to make a serious contribution to the over-all problem of coastal oceanography.

With the completion, at least for the time being, of the Block Island Sound survey, attention has again been turned to Long Island Sound (Fig. 1). This is a semienclosed body of water roughly 100 nautical miles long, with an area of about 930 square miles. It has a maximum depth of 100 m near the eastern end, but elsewhere there is little water of more than 30 m. At the eastern end there is free exchange between the Long Island and Block Island Sounds through a series of passes. Through a narrow channel at the western end, limited exchange takes place with the waters of New York Harbor.

The drainage basin is 13 times the area of the Sound, but more than 75% of the runoff enters the relatively open eastern end, where its effect on the Sound as a whole is minimal. The western end is

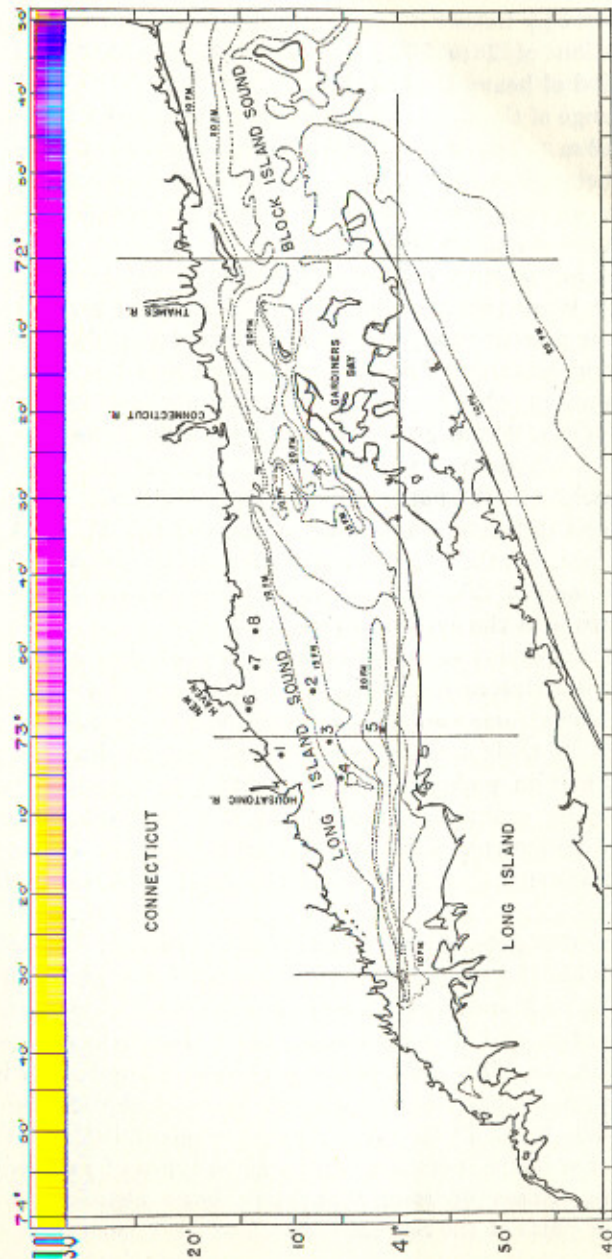

Figure 1. Chart of Long Island Sound and adjacent waters. Bottom depths are contoured at 10, 15, and 20 fathoms in Long Island Sound and 10 and 20 fathoms elsewhere. Routine station positions in the central part of the Sound are shown as numbered dots.

normally about 5‰ fresher than the eastern end, and there is a seasonal variation of 2 to 3‰, the minimum corresponding with the spring period of heavy land drainage.

The mean range of the tide is 0.75 m in the eastern end and increases westward to 2.2 m. The volume of tidal inflow is 8.2% of the volume of the Sound below mean low water. Strong tidal currents are found in the vicinity of the passes. Farther west the average tidal speed generally lies between 10 and 60 cm/sec.

The existing information on nontidal currents and transport was summarized by Riley (1952a). The problem will be reopened later. It suffices for the present to say that in Long Island Sound, as in many other sounds and estuaries, there is a tendency toward a two-layered transport system in which a relatively fresh surface layer moves eastward out of the Sound and is replaced by saline water moving inward along the bottom. An elementary application of the salt continuity principle in the paper cited suggested a total interchange by transport and diffusion amounting to about 30% of the volume of the Sound per month. Further work by more refined methods will somewhat modify this conclusion, but it serves to indicate the order of magnitude of the exchange rate.

In planning a general oceanographic survey of the region, it is apparent that descriptive knowledge of local populations and their environment, though necessary, is not sufficient in itself to provide a clear concept of their ecology. It is important to determine the extent to which local populations are modified by transport. Productivity must be evaluated in terms of the combined effects of enrichment by freshwater drainage, the gain and loss of nutrients by horizontal water movements, and the local rate of biological turnover.

Practical considerations of time and available personnel have made it desirable to divide the survey into two phases: For a period of two years, beginning in March 1952, weekly observations of physical and chemical properties and plankton have been obtained at positions indicated in Fig. 1. This area, while relatively limited, is believed to be fairly representative of the central basin of the Sound from Longitude 72°30' W to 73°05' W. At less frequent intervals there have been bottom fauna collections and various types of physiological studies. Three cruises of longer duration have obtained similar data from other parts of the Sound.

The first products of this investigation are reported herein, with papers on physical and chemical oceanography and various aspects of the biological program. Other parts of the survey will be published subsequently.

In March 1954, the scope of the investigation was broadened to general coverage of the Sound at approximately monthly intervals. There were four main purposes: (a) To obtain at least a minimum of data on regional variations in populations and seasonal cycles for comparison with the more detailed survey of these first two years. (b) To refine present knowledge of the movements of water within the Sound and the rate of exchange between the Sound and adjacent waters. (c) To attempt to distinguish between local biological events and transport effects in the development of pelagic populations. (d) To budget the cycle of nitrogen (the most important chemical element from the standpoint of limitation of plant growth) with respect to internal biological transformations, transport effects, and freshwater enrichment. This phase of the program is expected to continue for two or three years.

It is a pleasure to acknowledge our gratitude to the Office of Naval Research, which has supplied generous financial assistance to the project. Field work has been carried out aboard the laboratory vessel of the U. S. Fish and Wildlife Service Station at Milford, Connecticut. To Dr. Victor L. Loosanoff, Director of the Station, and to Captain Herman R. Glas of the SHANG WHEELER, we are deeply indebted for their kindness and help throughout the work. The work of various members of the group has been aided by part time undergraduate assistants: Charles E. Weems, Louis K. Mowbray, Francisco Wong, Jack Fu, and Henry Schurr. Special thanks are given to Daniel Merriman, who has given his time unstintingly in scientific and editorial advice and in administrative work in connection with the project.

REFERENCES

- DEEVEY, G. B.
 1952a. A survey of the zooplankton of Block Island Sound, 1943-1946. *Bull. Bingham oceanogr. Coll.*, 13 (3): 65-119.
 1952b. Quantity and composition of the zooplankton of Block Island Sound, 1949. *Bull. Bingham oceanogr. Coll.*, 13 (3): 120-164.
- MERRIMAN, DANIEL AND RUTH SCLAR
 1952. The pelagic fish eggs and larvae of Block Island Sound. *Bull. Bingham oceanogr. Coll.*, 13 (3): 165-219.

MERRIMAN, DANIEL AND H. E. WARFEL

1948. Studies on the marine resources of southern New England. VII. Analysis of a fish population. *Bull. Bingham oceanogr. Coll.*, 11 (4): 131-163.

RILEY, G. A.

1941. Plankton studies. III. Long Island Sound. *Bull. Bingham oceanogr. Coll.*, 7 (3): 1-93.

1952a. Hydrography of the Long Island and Block Island Sounds. *Bull. Bingham oceanogr. Coll.*, 13 (3): 5-39.

1952b. Phytoplankton of Block Island Sound, 1949. *Bull. Bingham oceanogr. Coll.*, 13 (3): 40-64.

SMITH, F. E.

1950. The benthos of Block Island Sound. Doctoral dissertation, Yale University.

OCEANOGRAPHY OF LONG ISLAND SOUND, 1952-1954

II. PHYSICAL OCEANOGRAPHY

BY

GORDON A. RILEY

Bingham Oceanographic Laboratory

TABLE OF CONTENTS

	<i>Page</i>
ABSTRACT.....	15
TEMPERATURE AND SALINITY DISTRIBUTION.....	16
METHODS.....	16
SEASONAL CYCLES IN THE CENTRAL PART OF THE SOUND.....	16
FACTORS AFFECTING SALINITY AND DENSITY DISTRIBUTION IN THE CENTRAL BASIN.....	19
HORIZONTAL DISTRIBUTION IN THE SOUND AS A WHOLE.....	23
EAST-WEST MASS TRANSPORT.....	24
VERTICAL EDDY CONDUCTIVITY.....	32
RADIATION AND TRANSPARENCY.....	35
RADIATION.....	35
MEASUREMENT OF TRANSPARENCY.....	36
ANALYSIS OF FACTORS INFLUENCING TRANSPARENCY.....	37
DISCUSSION.....	44
REFERENCES.....	46

ABSTRACT

Temperature and salinity data were obtained at eight stations in the central part of the Sound at weekly or biweekly intervals from March 1952 to March 1954. Seasonal trends and differences from one year to the next are discussed in relation to Weather Bureau data on air temperature and precipitation. Tidal mixing is sufficient to prevent the development of strong stability, although a small thermocline is present from February or March until the end of August; there is a vertical salinity gradient during most of the year. Direct current measurements indicate a weak nontidal drift, but possibly the currents are not continuously present, for observations on the horizontal distribution of salinity and density show that conditions favoring the maintenance of density currents are readily modified by transient winds. The distribution of temperature and salinity in the Sound as a whole is briefly described. Recent and previous current measurements are combined in a

generalized estimate of east-west mass transport, and problems of transport exchange and salt balance are discussed. The seasonal temperature cycle in the central basin is used to calculate vertical eddy conductivity coefficients for all of the two-year survey except the periods from mid-August to mid-November. The eddy coefficients are indeterminate during the early autumn, and it is suggested that convection is more important than turbulence in controlling this part of the seasonal cycle. Data on radiation and water transparency are presented, and the latter are analyzed with respect to phytoplankton, winds, currents, and other factors that affect transparency in shallow coastal waters.

TEMPERATURE AND SALINITY DISTRIBUTION

METHODS

Temperature measurements at each station included a bathythermograph lowering from surface to bottom as well as a surface temperature reading with a G-M bucket thermometer. BTs were read to the nearest tenth of a degree Fahrenheit at depth intervals of 2.5 m and converted to the nearest 0.05° C. Comparison of average surface readings with the corresponding thermometer temperatures was used to apply a systematic correction to BT readings when the average difference was as much as 0.05°.

Water samples for salinity determinations and other chemical analyses were collected with a Nansen bottle one meter below the surface, one to two meters above the bottom, and at one or two intermediate depths, the number depending on the depth. Salinities were titrated according to the simplified method described by Harvey (1928), using Woods Hole standard sea water to standardize the silver nitrate. The slightly superior accuracy of the Knudsen method is hardly warranted in neritic waters where the salinity range requires the use of two burettes and where local variability often exceeds the titration error.

SEASONAL CYCLES IN THE CENTRAL PART OF THE SOUND

Fig. 1 shows the temperature and salinity of the inshore waters from March 5, 1952 to March 10, 1954. Surface values are the averages of Sts. 1, 6, 7, and 8 (cf. INTRODUCTION, Fig. 1). The bottom temperatures represent depths of about 8 to 12 m and are averages of Sts. 1, 7, and 8. St. 6, in water of only about 4 m, is omitted.

The average temperature and salinity at offshore Sts. 2 to 5 are plotted in similar fashion in Fig. 2. The bottom depths range from

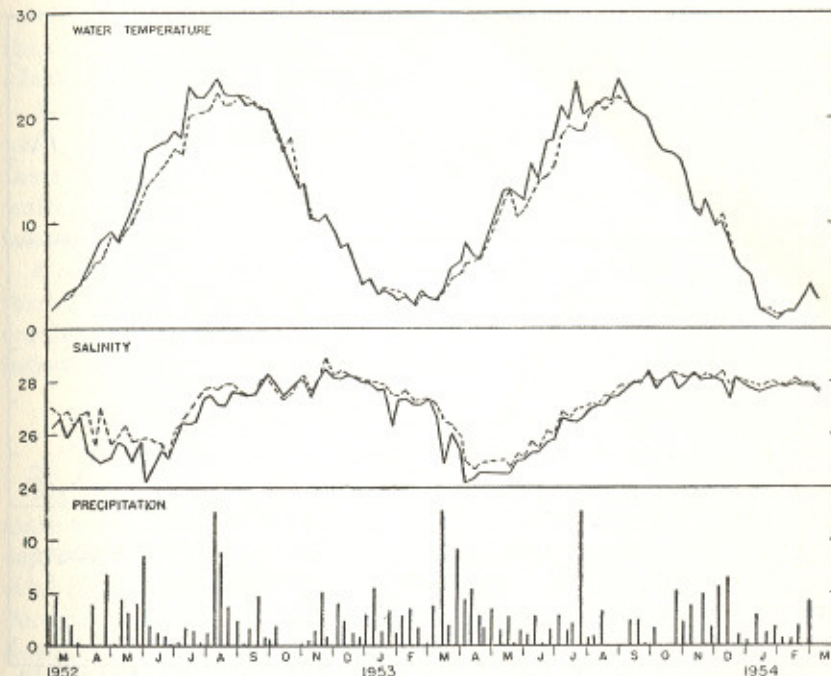

Figure 1. Average temperature (°C) and salinity (‰) at the surface (solid lines) and bottom (dashed lines) at inshore stations in the central part of Long Island Sound. Total precipitation (cm) between successive dates of oceanographic observation.

19 to 28 m. Included in the figures are data on precipitation (Fig. 1) and air temperature (Fig. 2) obtained through the courtesy of the New Haven office of the U. S. Weather Bureau. Weather data are recorded at 41° 16' N, 72° 53' W, half a mile from Long Island Sound and about three miles from Sts. 6 and 7. They are plotted here as average temperature and total precipitation between successive dates of oceanographic observation. Comparison of weather data for 1952-54 with the long-term means of the Weather Bureau shows that in 1952 the summer air temperatures were about 1° C above average, the autumn temperature approximately normal. But the winter of 1952-53 was one of the warmest on record, with individual monthly means ranging from 1.6 to 3.5° C above the long-term average. The spring and autumn of 1953 were also above average, the summer normal. Warm weather persisted through December, but January 1954 was 1.4° below normal.

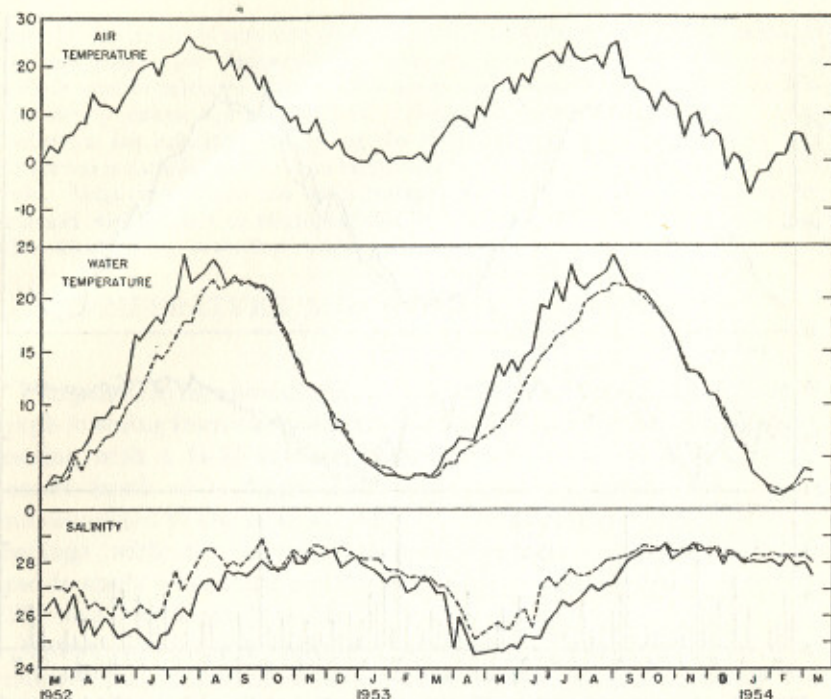

Figure 2. Weekly averages of air temperature ($^{\circ}\text{C}$) recorded by the New Haven Weather Bureau. Average water temperature ($^{\circ}\text{C}$) and salinity (‰) at surface (solid lines) and bottom (dotted lines) at offshore Sts. 2 to 5.

These differences in air temperature are reflected in sea surface temperatures. The latter were slightly warmer in the summer of 1952 than in 1953. Autumn cooling in 1953 lagged two or three weeks behind the preceding year. However, rapid cooling in January 1954 produced a midwinter minimum that was normal or perhaps below average for the area and was nearly 3° colder than the year before.

The total precipitation was 119 cm in 1952 and 137 cm in 1953, as compared with an 81-year mean of 117.5 cm. March and April 1953 were excessively wet, and the salinity dropped off rapidly at that time. Otherwise there were no marked differences in salinity between one year and the next. It has been suggested previously (Riley, 1952) that the volume of freshwater drainage regulates the rate of transport exchange, so that the salinity tends to be held at a

relatively constant level. This theory is strengthened by the fact that a 15% increase in rainfall in 1953 had only a small and transient effect on the general salinity level.

A small thermocline was found each year from February or March until the end of August. Tidal mixing was strong enough so that the surface layer was seldom more than 5° warmer than the bottom water. Positive temperature gradients of as much as 1° have been found in winter.

A small vertical salinity gradient was present most of the time. It tended to be maintained, irrespective of thermal stability, by the combined effects of freshwater dilution of the surface layer and the inflow of saline water along the bottom.

FACTORS AFFECTING SALINITY AND DENSITY DISTRIBUTION IN THE CENTRAL BASIN

Fig. 3 is a chart of the central part of the Sound, reviewing routine station positions and showing measurements of nontidal surface currents. The latter include estimates based on measurements of tidal currents by the U. S. Coast and Geodetic Survey and additional current stations obtained during the present survey, using the method described by Pritchard and Burt (1951).

Many small streams empty into the Sound along the northern shore of the central and western basins, and the Housatonic is a river of moderate size, accounting for approximately one-tenth of the total drainage into the Sound. Previous surveys have commonly shown reduced salinity in the northern inshore waters. This, combined with the evidence from current measurements, led to the hypothesis (Riley, 1952) that a coastwise density current begins in the vicinity of New Haven, flows westward and gives rise to a counter-clockwise gyral in the western half of the Sound.

Between New Haven and the mouth of the Housatonic River, but not including the latter, the total freshwater drainage varies seasonally between about 0.3 and 1.5 million m^3/day . The major part of this water comes from rivers emptying into New Haven Harbor. Assuming an average coastwise drift of about two miles a day (this is the mean of the available current measurements and is in agreement with the observed movement of oil accidentally dumped into New Haven Harbor), the drainage could reduce the salinity about 0.12 to 0.60 ‰ in a strip of coastal water two miles

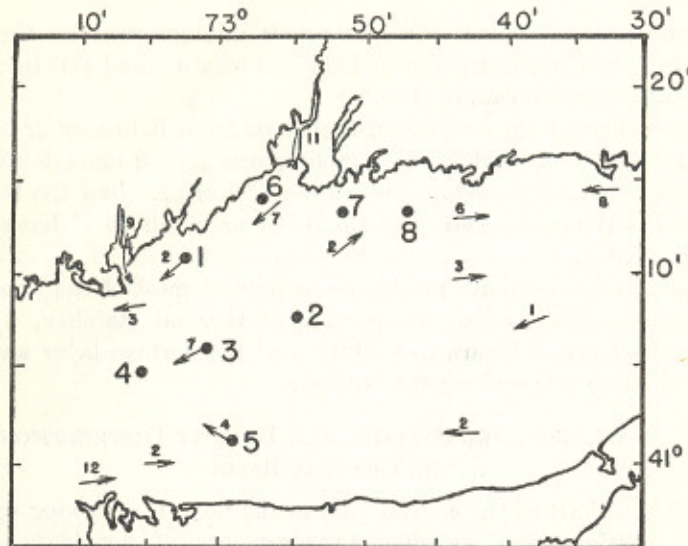

Figure 3. Chart of central Long Island Sound. Dots and large numbers indicate routine stations. Arrows and small numbers show observed direction and speed of nontidal drift in centimeters per second. Values at Sts. 1, 3, and 5 were obtained during the present survey. Others are estimates from Riley (1952), based on U. S. Coast and Geodetic Survey tidal current charts.

wide. The Housatonic River, on the other hand, has a drainage volume roughly an order of magnitude larger than the figures cited above, and wherever its outflow goes, it may be expected to have a correspondingly greater effect on salinity.

During the recent survey, about 5% of the observations at St. 1 have revealed a markedly reduced surface salinity that was almost certainly due to Housatonic River influence. The mouth of the river is three miles west of St. 1 and only slightly beyond the limits of the normal ebb tide excursion. Hence an occasional effect of this kind does not seriously contradict the theory of a general westerly drift.

However, for other reasons the theory needs to be re-examined and somewhat modified. Whatever the actual water movement may be, it has become apparent that conditions tending to generate a density current are not continuously present. Water of relatively low density has been found only about half of the time at St. 1. With northerly and westerly winds it has been common to find water of lower density in the surface layer offshore; concomitantly, the water at St. 1 has temperature and salinity characteristics which are typical of mid-depth

or bottom water from the offshore region. It has also been common at such times to find eddies of fresh water containing debris of terrestrial origin in the vicinity of St. 4. The most likely source of such water is the Housatonic River five miles to the north. In order to present the data as a whole in simple form, differences in surface water density (σ_t) between Sts. 3 and 1 have been tabulated in the first part of Table I in relation to wind direction. The coastline in this area is oriented approximately SW to NE. Water movement is likely to be somewhat to the right of the wind. Offshore movement is therefore most likely to occur with north to southwest winds.

TABLE I. FREQUENCY DISTRIBUTION AND AVERAGE MAGNITUDE OF DENSITY AND SALINITY GRADIENTS IN RELATION TO WIND DIRECTION DURING THE DAY PRECEDING THE OBSERVATIONS

Wind direction	N to SW	S to NE
Density gradient, St. 3 minus St. 1		
+	11	11
-	22	2
Mean	-.12	.20
Salinity gradient St. 4 minus St. 3		
+	11	7
-	21	6
Mean	-.25	.02

Sts. 1 and 3 were ordinarily occupied about 9-10 A.M. Wind data are averaged by the Weather Bureau from midnight to midnight. Thus the most pertinent wind data are for a period of roughly 33 to 8 hours preceding the station observations. This is hardly ideal; nevertheless, the results in Table I clearly show a relation between density distribution and transient winds. Plus signs designate the number of occasions when a positive density gradient was found, a condition favoring the establishment of a coastwise density current. Minus signs indicate the frequency distribution of denser water inshore, which is presumed to be associated with offshore movement and upwelling. The next line of Table I is the mean of all observations, positive and negative, for each group.

The second half of Table I presents an analogous comparison of surface salinities at offshore Sts. 3 and 4. With southerly and easterly winds there is no significant difference and none to be expected. With northerly and westerly winds, about two-thirds of the observations indicate a freshening effect, which is postulated to be due primarily to southward transport of Housatonic River water.

Although it would appear in Table I that the wind effect is transient, it is reasonable to suppose that there might be a prevailing pattern of density distribution over a period longer than a day or a few days, corresponding to patterns of prevailing winds. Table II shows vectorial averages of wind speed in miles per hour and direction by semimonthly periods during the summers of 1952 and 1953. Below these figures are listed all of the observed differences in sigma-t between Sts. 3 and 1 for each period; also listed are differences between Sts. 2 and 1. The latter are regarded as somewhat inferior in quality because the stations are widely separated, but they greatly increase the total amount of data available for examination.

TABLE II. COMPARISON OF SEMIMONTHLY AVERAGES OF WIND SPEED AND DIRECTION WITH OBSERVED HORIZONTAL DENSITY GRADIENTS

	June		July		August	
	1-15	16-30	1-15	16-31	1-15	16-31
1952						
Wind direction	252	268	200	254	—	225
Wind speed	2.1	1.7	1.7	3.7	0.0	1.5
Density difference, 3-1	—	.02	-.37	+.17	-.18	-.12
2-1	-.10	-.60	-.34	-.67	-.86	-.38
	—	-.42	-1.26	-.38	.07	.20
	—	—	-.43	—	—	—
1953						
Wind direction	250	197	077	053	067	238
Wind speed	2.3	3.1	0.5	0.1	1.3	2.2
Density difference, 3-1	-.36	.07	.25	.01	.09	-.45
	-.38	—	—	—	—	—
2-1	-.11	-.29	-.29	.00	.08	-.25
	-.18	.38	.03	-.15	.00	-.40
	-.07	—	—	—	—	—

During the summer of 1952, the prevailing winds were westerly, and the preponderance of negative gradients indicated considerable offshore movement and upwelling. The winds were southerly and easterly for two months in the summer of 1953. A majority of the horizontal gradients at that time were positive, suggesting that the inshore water mass was sufficiently stable to become freshened by river drainage, even though the latter is relatively small in summer.

Differences of this type from one year to the next may be important biologically. Many species of bottom invertebrates find a suitable substrate only in the inshore waters, and successful reproduction requires that their planktonic larvae reach the stage of metamorphosis

in the coastal zone. Winds that maintain a stable inshore water mass during the period of planktonic existence therefore favor a successful year class. The pattern of prevailing winds may also affect phytoplankton production. However, the latter is a much more complex problem, since it involves the effect of wind on both physical dispersal and the rate of supply of nutrients by upwelling.

The remainder of the two-year period has been examined in the same way. Qualitatively the relationship between winds and density distribution holds throughout, but the quantitative aspects of the relationship vary considerably from one season to another. There are periods in autumn and early winter when strong westerly winds have little effect on the density distribution. This simply means that the Sound is thoroughly mixed and that no amount of upwelling can create a pronounced horizontal gradient. Contrariwise, during the spring peak in freshwater drainage, positive density gradients tend to be maintained despite northerly winds.

With regard to the other inshore sampling positions, St. 6, just inside the New Haven Harbor breakwater, ordinarily had a slightly reduced salinity, as might be expected. St. 7 occasionally showed slight harbor influence on the ebb tide. None was noted at St. 8, which is in an area where previous studies suggested the possibility of a diffuse northerly drift, completing the postulated counterclockwise gyral in the western half of the Sound. No definitive evidence on this subject has since been obtained. However, salinities have been generally similar to these at offshore St. 2 and have exhibited no freshening effect that might be due either to easterly movement from New Haven Harbor or to a coastwise density current originating from the Connecticut River.

HORIZONTAL DISTRIBUTION IN THE SOUND AS A WHOLE

Previous observations on the general distribution of temperature and salinity in the Sound have been summarized by Riley (1952). Since that time, three additional cruises have been made. Surface observations are shown in Figs. 4 to 6. The east-west salinity gradients and the seasonal change in salinity are more or less similar to what has been described before. Fig. 5 represents a typical autumn distribution, with relatively high salinity throughout the Sound. During the two spring cruises the rivers were in flood, and Figs. 4 and 6 show the effects of freshwater drainage to an extreme degree. The

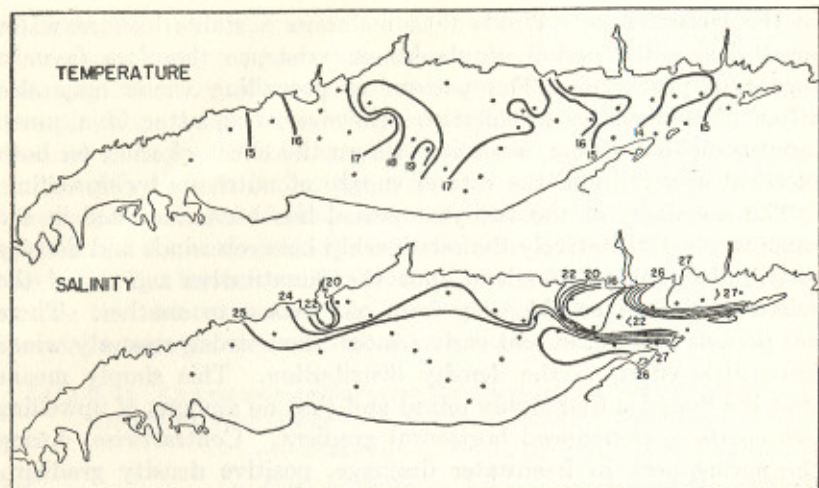

Figure 4. Surface temperature ($^{\circ}\text{C}$) and salinity (‰), June 4 to 11, 1952. Dots indicate positions of observation.

outflow from the Connecticut River was largely responsible for reduced surface salinities in the eastern end of the Sound. This outflow was readily observed at sea as a muddy surface layer with clearly defined boundaries, in one case extending all the way from the mouth of the river to its exit through the eastern passes. The maximum observed westward extension of the muddy water was some five miles west of the mouth of the Connecticut River.

EAST-WEST MASS TRANSPORT

In this Sound, as in many other sounds and estuaries, current profiles of the sort shown in Fig. 7 generally indicate that the ebb is stronger than the flood in the surface layer but weaker than the flood in the bottom water. Averaging through a tidal cycle at the particular current station figured, it was estimated that the surface water moved 6.5 km east, the bottom water 2.2 km west, giving a total divergence of 8.7 km or 4.7 nautical miles during a complete tidal cycle.

LeLacheur and Sammons (1932) described an extensive set of surface current measurements at Bartlett Reef Lightship in the eastern end of the Sound. Their series extended from August 1929 to March 1930, during which period the monthly averages for nontidal

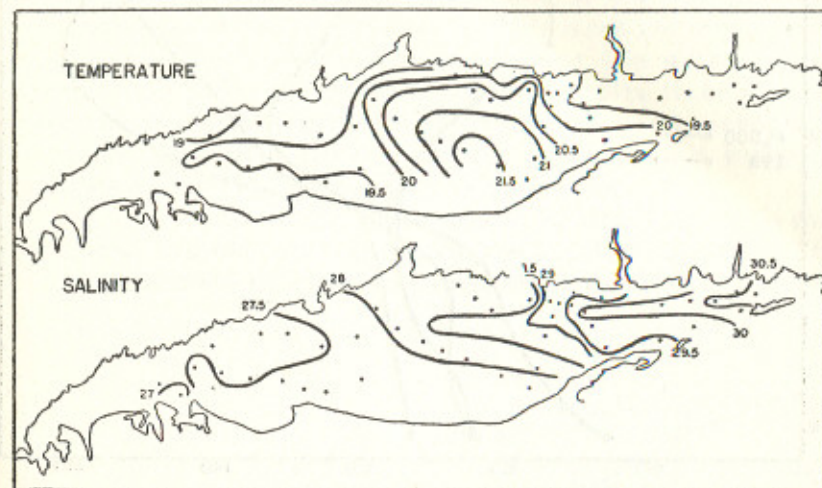

Figure 6. Surface temperature ($^{\circ}\text{C}$) and salinity (‰) September 29 to October 8, 1952.

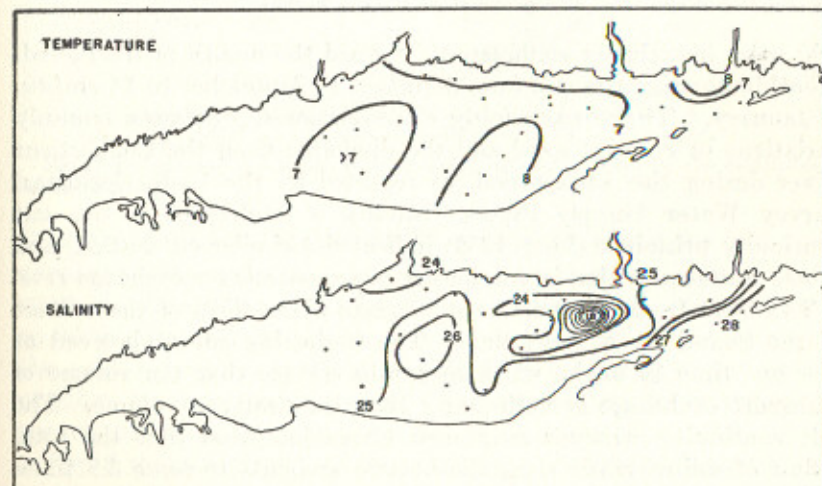

Figure 6. Surface temperature ($^{\circ}\text{C}$) and salinity (‰), April 6 to 15, 1953.

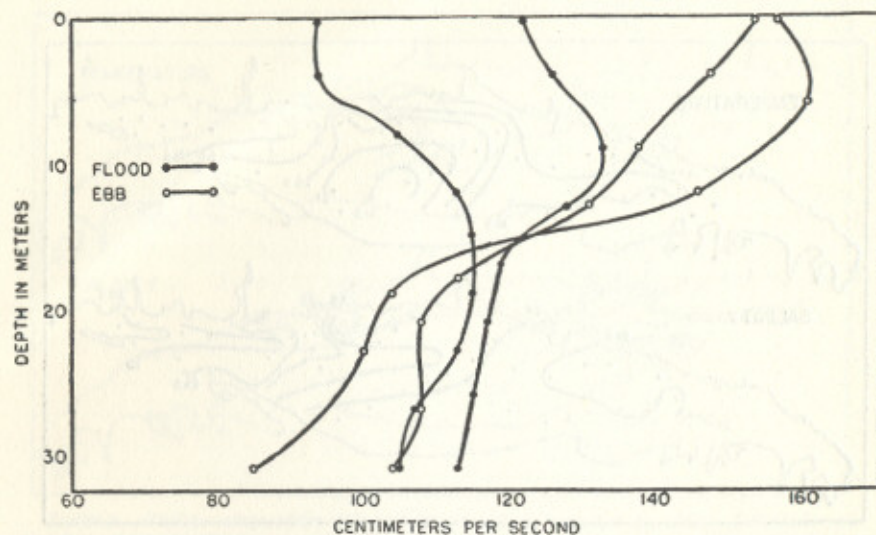

Figure 7. Observations of tidal currents at an anchor station in east-central Long Island Sound (Lat. $41^{\circ}11.9'N$, Long. $72^{\circ}29.4'W$) on April 6 and 7, 1953. Measurements were obtained with Pritchard and Burt (1951) current crosses at one-hour intervals, and the two sets of profiles shown were the ones nearest midebb and midflood.

drift were invariably southeasterly, toward the mouth of the Sound. Monthly averages ranged from 5 cm/sec. in September to 14 cm/sec. in January. There was a fairly close relationship between monthly variations in current speed and the discharge from the Connecticut River during the same period, as reported by the U. S. Geological Survey Water Supply Papers. Studies of exchange by the salt continuity principle (Riley, 1952) indicated a similar correlation, and it was postulated that freshwater drainage controls the exchange rate.

The total freshwater drainage averages about 35% of the volume of the Sound in a year's time. The freshening effect observed at any one time is slight, which means in essence that the volume of transport exchange is much larger than the drainage volume. The salt continuity analysis mentioned above indicated that the total inflow of saline water along the bottom amounts to some 3.8 times the volume of the Sound in a year. However, this gross exchange rate for the Sound as a whole is not necessarily applicable to any particular locality. The matter needs to be examined more fully, with particular emphasis on local variations in transport exchange, because much of the discussion of biological and chemical oceanography will

hinge upon the relative stability or mobility, as the case may be, of populations and chemical elements. Material is not yet available for a definitive treatment of the subject, including the effects of both currents and diffusion. However, diffusion appears to be relatively insignificant in estuaries (Pritchard, 1952), so that an evaluation of mass transport from observed currents should give a sufficiently accurate estimate of exchange for present purposes.

Important as nontidal transport may be, its actual volume is small compared with ordinary tidal oscillations, and it is readily modified by winds and density currents. Variations in residual flow of more

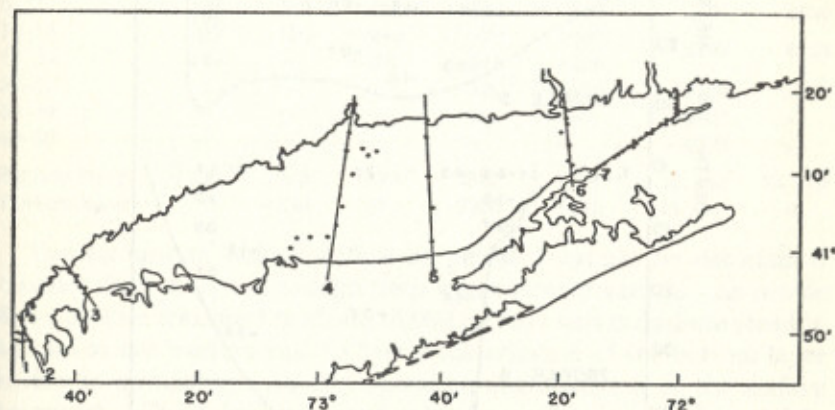

Figure 8. Positions of current stations (dots) and profiles used in the calculation of east-west transport.

than 20% have been noted between one tidal cycle and the next under conditions that seemed to be reasonably comparable. Much of the available station data includes only one tidal cycle. Hence there is no likelihood that all of the observed variation from one station to the next is real. The problem then is to determine whether it is possible, by statistically combining many stations, to derive a consistent pattern of mass transport.

Fig. 8 shows a pattern of stations that will be used for estimating east-west transport across the lines indicated in this figure. The data were obtained in the summers of 1890, 1917, 1929 (LeLacheur and Sammons, 1932) and 1953. The published data listed the duration and maximum velocity of flood and ebb at the surface and usually at two or three subsurface levels. Residual transport was calculated

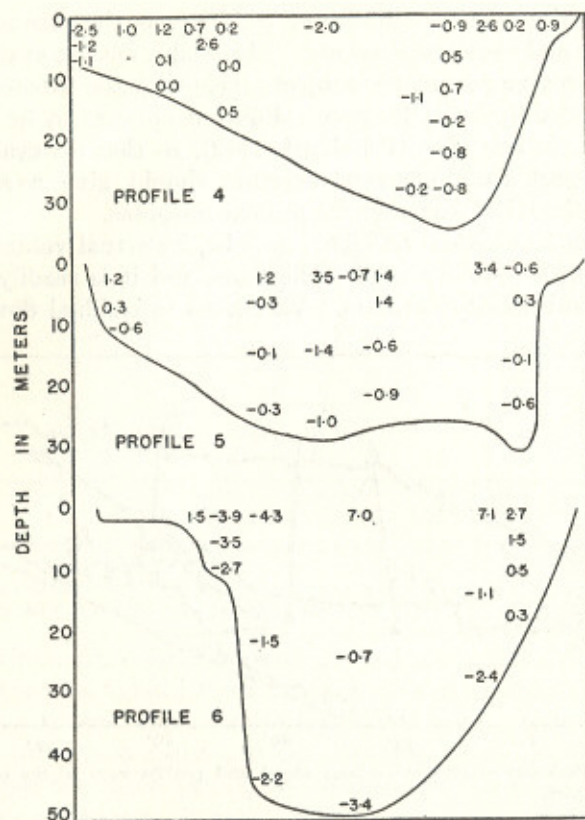

Figure 9. Estimated nontidal drift in nautical miles per tidal cycle through three of the profiles shown in Fig. 8. Positive numbers indicate eastward movement, negative numbers, westward.

by assuming that the mean velocity was two-thirds the maximum, multiplying this figure by the duration, and then taking the difference between flood and ebb. The 1953 data, consisting of half-hourly readings at four to six depths, were numerically integrated through the tidal cycle. Fig. 9 is an example of the type of results obtained. Transport is shown in nautical miles during a tidal cycle through three of the profiles previously identified by lines and numbers in Fig. 8.

The profiles provide a basis for calculating the volume transport through successive cross sections of the Sound. However, the amount

of variation from depth to depth and from one station to another introduces a subjective element into the interpolation. The results of the calculations, which must be regarded as tentative because of the many possible sources of error, are presented in Table III.

TABLE III. VOLUME TRANSPORT IN M^3 PER SECOND THROUGH PROFILES 1 TO 7 (FIG. 8). POSITIVE NUMBERS INDICATE EASTWARD MOVEMENT; NEGATIVE ARE WESTERLY

Depth Meters	Profile						
	1	2	3	4	5	6	7
0-5	680	740	860	2100	4830	7130	9150
5-10	320	540	480	760	750	4870	4830
10-15	100	-130	-240	-70	-1460	2130	4910
15-20	—	—	-330	-840	-1380		
20-30	—	—	—	-1390	-2850	-4100	—
30-40	—	—	—	—	—	-6840	—
40-50	—	—	—	—	—	-4070	—
Surface layer	1100	1280	1340	2860	5580	14,130	18,890
Bottom layer	0	-130	-570	-2300	-5690	-15,010	—

The amount of bottom inflow at profile 7 cannot be determined because there were not enough deep water measurements. At profile 6 the bottom transport is about 15,000 $m^3/sec.$, and it declines steadily to zero at the western end. Clearly the attrition of the bottom layer is due to upwelling, with corresponding augmentation of the surface transport. The calculated mean rate of upwelling required to satisfy the principle of mass continuity is very small. In most of the central and western part of the Sound it is of the order of 5 to 8 cm/month and increases eastward to a maximum of about 45 cm in the vicinity of the passes.

It would appear that about 1100 $m^3/sec.$ enter the western end of the Sound and flow eastward as part of the surface layer. The latter is further augmented by freshwater drainage, amounting to about 300 $m^3/sec.$ in summer in the whole of the Sound. Thus the surface outflow at the eastern end should exceed the inflow by about 1400 $m^3/sec.$, but the transport estimates are not accurate enough to show this.

Fig. 10 is a diagram of transport exchange derived by combining theoretical considerations and calculated transport. The difference between surface and bottom flow, 1100 $m^3/sec.$ at the western end of the Sound, gradually increases to 1400 m^3 in an easterly direction in

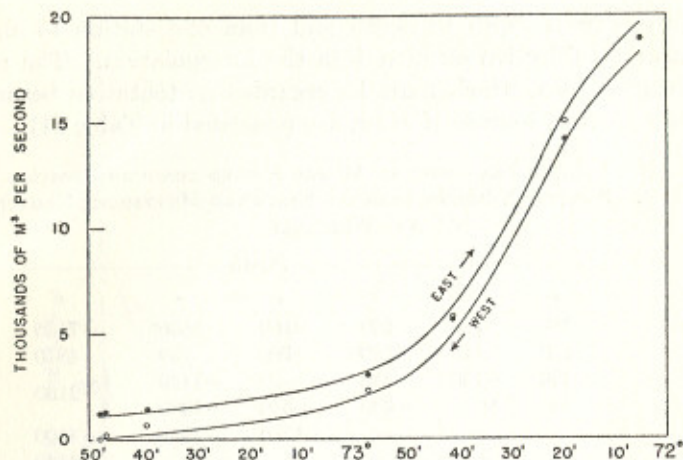

Figure 10. Calculated eastward surface transport (dots) and westward bottom transport (circles), and a schematic transport diagram derived from the calculations.

accordance with the known addition of fresh water. The total exchange increases as a smooth curve that is fitted as well as can be to the calculated transport data. The results, which appear to be internally consistent, agree more or less with previous calculations of inflow by the salt balance method. The latter gave a generalized estimate of 8400 m³/sec. during the summer of 1946, a figure that falls within the limits of variation of observed transport, as might be expected.

Fig. 10 indicates that transport declines rapidly toward the central area, which is particularly concerned in the present survey. Three months appear to be required, on the average, for bottom water to move through the 20 minutes of longitude occupied by the eight routine stations in the central basin, two months for the eastward transport of surface water. Obviously small parcels of water can be expected to move through the area much more rapidly than the general average. Nevertheless, the central water mass appears to be much less mobile than might have been supposed on the basis of salt balance calculations for the Sound as a whole.

There is the further implication in these results that freshwater dilution of the central and western parts of the Sound is largely of local origin. If any considerable fraction of the drainage from the large eastern rivers penetrated into the central basin, the compensating

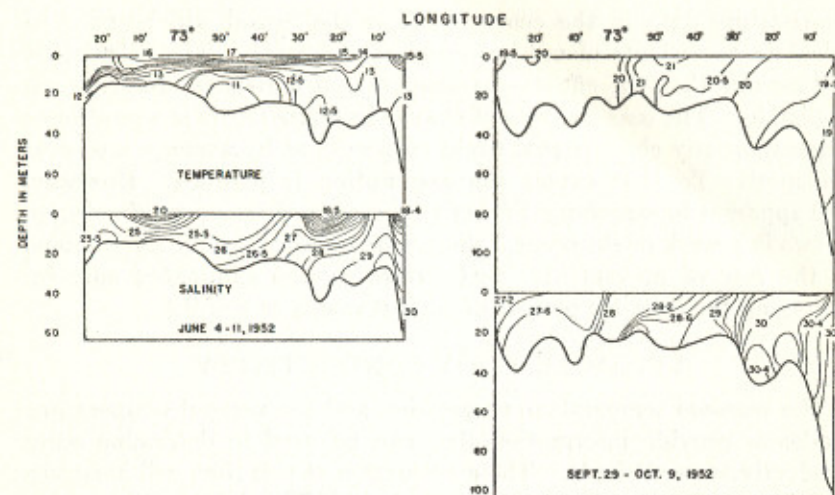

Figure 11. Longitudinal profiles of temperature ($^{\circ}$ C) and salinity ($^{\circ}$ / $_{\infty}$) in Long Island Sound.

transport would have to be much larger. So far as direct observations are concerned, no evidence has thus far been found either of a coastwise density current originating at the mouth of the Connecticut River or of offshore eddies moving west from the main mass of river outflow.

Fig. 11 shows two sets of longitudinal profiles of temperature and salinity. They are included here rather than in the section on horizontal distribution for convenient examination of the relations between mass transport and the distribution of conservative properties. The salinity diagrams clearly show the westward penetration of saline water along the bottom as well as the resulting slope of the isohaline surfaces. There are a few isolated pockets of water of different salinity that suggest variations in transport of one kind or another. There are also indications in routine station data for the central part of the Sound that the influx of saline bottom water may be somewhat intermittent.

The effects of east-west transport may be detected in the temperature distribution during the autumn cruise (see Fig. 11), but they are not apparent in the spring cruise. In general, local surface heating and cooling are more important than transport in determining the character of the temperature distribution. In the next section, local

temperature data in the central part of the Sound will be used to calculate coefficients of vertical eddy conductivity. The calculation will assume that the effects of transport and horizontal diffusion are negligible. The seasonal rate of change in temperature is many times larger than any changes that could be produced by average east-west transport. To that extent the assumption is justified. However, it is apparent in examining Fig. 11 that more serious errors of a degree or two in a week might occur if there were occasional large fluctuations in the rate of movement. Such errors can be eliminated only by averaging the data for periods of several weeks or months.

VERTICAL EDDY CONDUCTIVITY

The seasonal temperature progression and the vertical temperature gradients provide information that can be used to determine eddy conductivity coefficients. Their evaluation at this time will illustrate certain aspects of the thermal cycle in the Sound and will provide data for later analyses of nutrient and production problems. The later applications will presuppose that coefficients of vertical eddy conductivity are the same as the diffusivity coefficients. This is a debatable point. There are certain theoretical reasons for believing that thermal coefficients should be larger. On the other hand, Riley (1951) examined eddy coefficients calculated from both temperature and salinity distribution and detected no essential difference. There is undoubtedly less error in using temperature for this purpose than in attempting the more complicated and unwieldy determination of eddy diffusivity as indicated by salinity distribution.

Ignoring the effects of advection and horizontal mixing, the vertical flux of heat attendant upon surface heating and cooling may be written

$$F = - \frac{A}{\rho} \cdot \frac{\partial T}{\partial z} \quad (1)$$

F is the rate of passage of heat through one square centimeter of horizontal surface at any specified depth. A is the coefficient of eddy conductivity, ρ the density, and $\partial T/\partial z$ the vertical temperature gradient.

Under the simplifying assumptions that have been adopted, the heat flux is readily obtained from observed water temperatures. Suppose that, in a total depth of water of 20 m, the lower 10 m increases half a degree in a week's time. The amount of heat that has

passed through 1 cm² of horizontal area at a depth of 10 m is 500 g cal., and

$$F = \frac{500}{7 \times 86400} = 0.83 \times 10^{-3} \text{ g cal./sec.}$$

Further, suppose that during this time the temperature in the vicinity of the 10 m level—say between 8 and 12 m—has shown an average negative gradient of 0.5° C in the 4 m interval. The density is about 1.02. Applying equation (1) in finite difference form,

$$0.83 \times 10^{-3} = \frac{-A}{1.02} \cdot \frac{-0.5}{4 \times 10^2},$$

$$A = 0.68 \text{ g cm}^{-1}\text{sec}^{-1}.$$

In applying this method to the seasonal temperature cycle in the Sound, it is necessary to develop an analysis that takes due account of both the inherent limitations of the data and the further uses for the calculated coefficients. First, it is apparent that relatively small sampling and analytical errors can assume serious proportions in any calculation requiring the use of gradients. The only way to minimize such errors is to combine data. It is therefore advisable to calculate average coefficients over considerable periods of time and also to combine stations when this can be done in a reasonable way. In the present case, Sts. 1, 7, and 8 are of comparable depth and will be combined into a single analysis. Also Sts. 2 and 4 will be combined, as will Sts. 3 and 5. The fact that the stations in each group are of similar depth is important for present purposes, and there is another and more practical reason for combining them in this way. Oxygen and phosphorus were sampled at approximately the same depths within each of the proposed groups. It will be necessary later to calculate the rate of exchange of these elements between the depths sampled, and therefore the eddy coefficients must be calculated for the same depth ranges. This is done by averaging vertical temperature gradients between 0 and 5 m, 5 and 10 m, etc., and determining the heat flux through the midpoints of each stratum, namely 2.5, 7.5, and 15 m. This operation is facilitated by the fact that temperatures were obtained from bathythermograms and could be read easily at any desired depth.

With regard to the seasonal cycle, eddy coefficients are most easily obtained during the spring and summer warming period, when vertical

temperature gradients are fairly pronounced. This period may be analyzed as a whole or broken up into smaller units. With later biological needs in mind, it was desirable to divide into three units. The first was relatively short, encompassing the spring diatom flowering or as much of it as occurred within the limits of vernal warming. The remainder was divided into two approximately equal periods, the first constituting post-flowering spring conditions, the second including most of the summer.

About the middle of August or the first of September, the water column began to cool from surface to bottom. Vertical temperature gradients were small and variable, but the average condition for the next three months was a slight negative gradient. Under such conditions vertical eddy conductivity could not be calculated and probably was less important than convection in controlling the seasonal temperature change.

During the remainder of the cooling period, from mid-November until late winter, the common condition was isothermal water or a slight positive gradient. Coefficients of eddy conductivity could be calculated, but they tended to be large and highly variable. What appeared to be a reasonable average could be obtained by combining large quantities of data, although there is some likelihood that convection continued to be important during this period. With reservations because of this possibility of error, generalized averages for winter eddy conductivity are as follows: 0 to 5 m, 24 g cm⁻¹sec.⁻¹;

TABLE IV. COEFFICIENTS OF VERTICAL EDDY CONDUCTIVITY (G CM⁻¹SEC⁻¹)
CALCULATED FROM OBSERVED TEMPERATURE DISTRIBUTION AND
SEASONAL CYCLES

Stations Depth range in meters	1, 7, 8		2, 4			3, 5		
	0-5	5-9	0-5	5-10	10-20	0-5	5-15	15-25
1952								
Mar. 5-May 21	1.36	0.51	1.76	1.80	1.16	2.12	2.08	0.96
May 21-Aug. 19	0.85	0.22	0.75	0.68	2.62	1.40	1.33	2.77
1953								
Feb. 10-Mar. 16	2.13	3.55	1.06	1.26	2.70	1.10	1.62	2.70
Mar. 16-May 18	1.10	0.35	0.73	0.79	3.36	1.90	1.75	1.97
May 18-Aug. 25	0.36	0.19	0.79	0.92	1.30	2.16	1.34	1.41
1954								
Jan. 25-Feb. 24	5.5	1.81	1.13	2.26	2.33	6.1	6.1	2.60

5 to 12.5 m, 9.8; 12.5 to 20 or 25 m, 9.0. These figures are based on all available station data from mid-November until the end of the winter cooling period for both years of observation. Calculated values for the spring-summer warming period are shown in Table IV. All of these coefficients are much less than those in winter. Minimum values are found in the surface layer or at mid-depths, depending upon the position of the thermocline. The coefficients are not seriously reduced in the deepest water examined, presumably because of strong tidal mixing.

RADIATION AND TRANSPARENCY

RADIATION

Data on total daily radiation in g cal/cm² are recorded by the U. S. Weather Bureau at two stations on Long Island. Local variations are important enough so that it was desirable to obtain estimates of radiation nearer the scene of oceanographic operations. The New Haven Weather Bureau is favorably situated but records only the number of hours of sunshine and the amount of cloud cover. However, statistical analysis of a two-year set of data from New York City indicated that measurements of the total amount of sunshine recorded at New York could be converted to estimates of total radiation with sufficient accuracy for present purposes. The analysis was not significantly improved by including a term for percent of cloud cover, presumably because the effect of clouds on radiation depends more upon their quality than upon the total amount.

In estimating total radiation for the New Haven area, the percentages of total possible sunshine were averaged for the periods between successive weekly cruises and applied to a graph constructed on the basis of the New York analysis. The graph contained a systematic correction for the effects of metropolitan haze in New York, which was obtained by adjusting the New York figures to the mean values obtained at the Long Island Stations. The net result is that New Haven estimates may contain a small systematic error, but fluctuations from week to week in the area of oceanographic operations should be relatively accurate. Fig. 12A shows the radiation estimates for New Haven, together with monthly averages of the pyrheliometric measurements at the two Long Island stations.

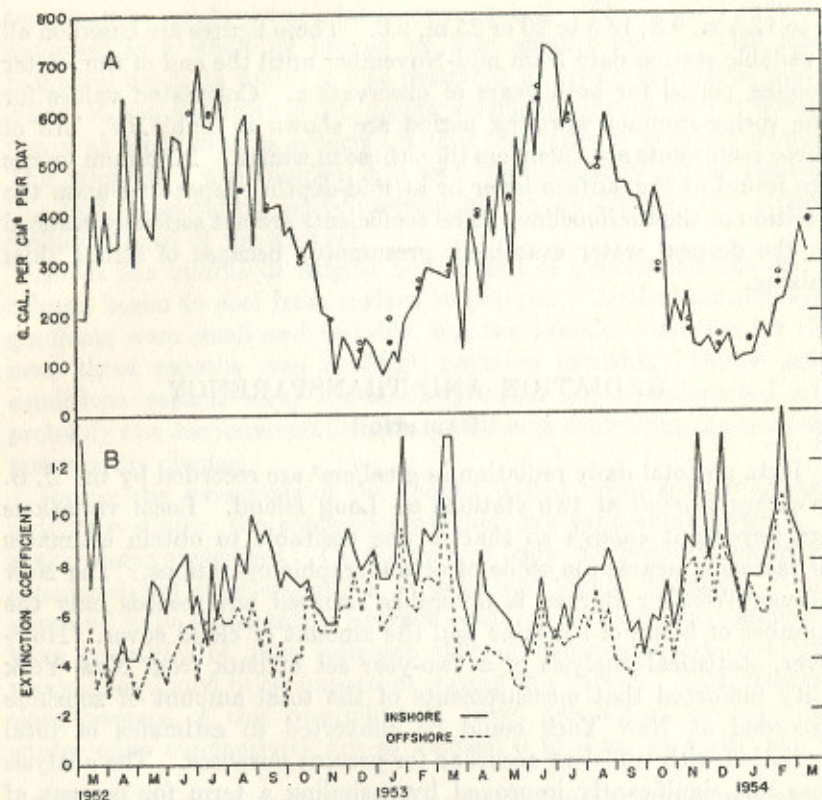

Figure 12. A. Direct plus diffuse solar radiation. Dots and circles are monthly averages of pyrbeliometric measurements by the U. S. Weather Bureau at two stations on Long Island. Solid line shows weekly averages of estimates obtained for the New Haven area by methods described in the text. B. Estimates of average extinction coefficients in the inshore and offshore waters based on Secchi disc readings.

MEASUREMENT OF TRANSPARENCY

Two methods have been used to measure the transparency of Long Island Sound waters. The first is the so-called Secchi disc reading; a 20 cm white disc is lowered in the water, and the mean depth of disappearance and reappearance is recorded. Results are shown in Fig. 12B as estimated average extinction coefficients at inshore and offshore stations, determined by application of the Poole and Atkins (1929) formula,

$$K = \frac{1.7}{D}, \quad (2)$$

where K is the extinction coefficient per meter and D is the Secchi disc depth in meters. The second measurement was a photoelectric determination of the extinction coefficient of red light in each water sample, using a Klett 66 filter, with ordinary laboratory distilled water as the reference blank. The primary purpose was to obtain a correction factor for turbidity in colorimetric determinations of phosphate. The measurements were made in a 4 cm cell, which is not long enough for highly accurate determination of transparency. Nevertheless, they are useful for detecting gross changes in transparency with depth.

In other papers of this series it will be necessary to calculate the light intensity at various depths. In general, the Secchi disc readings are sufficient. However, in particular cases the extinction coefficients varied so markedly with depth that a correction factor seemed desirable if it could be obtained in a reasonable way. According to Jerlov (1951), the two types of measurements are not strictly comparable. Moreover, a measurement with red light minimizes the effect of dissolved "yellow substance". Notwithstanding these technical objections, there is a moderately satisfactory empirical relation between the two sets of measurements. Statistical comparison of some 460 surface water extinction coefficients with the corresponding Secchi disc readings shows a correlation of 0.74 and yields the equation

$$K = .96K_1 + .246, \quad (3)$$

where K is derived from the Secchi disc reading according to equation (2) and K_1 is the extinction coefficient for red light as determined above.

ANALYSIS OF FACTORS INFLUENCING TRANSPARENCY

It has been recognized for many years that light extinction in sea water is a complex process involving absorption and scattering by the water, dissolved solids, and a variety of suspensoids. The latter include plankton, planktogenic detritus, and—particularly near land—bottom sediments in suspension and particles of terrestrial origin.

In Long Island Sound all of these factors are expected to be operative. In waters of this type, no one has tried very hard to formulate a quantitative expression for the various factors that govern transparency, although it is not only a problem of considerable intrinsic interest but also has an important bearing on several aspects of

biological oceanography. Sufficient data have now been amassed for a cursory analysis of transparency in the central part of the Sound.

First to be considered is the general problem of absorption and scattering of light by plankton. Rodhe (1948) and others have measured the extinction coefficients of pure algal cultures and have found, in any one species, a nearly linear relationship between extinction and cell number or chlorophyll concentration. Clarke (1946) compared pigment measurements of natural phytoplankton populations on Georges Bank with Secchi disc estimates of transparency and demonstrated a significant relationship between them. In an attempt to refine this comparison, Fig. 13 presents a group of data that is believed to represent the relation in its simplest possible form, namely (a) observations during the spring flowering on Georges Bank, a period when a rapid reduction in transparency coincided with the increase in phytoplankton, and (b) all available observations in deep oceanic waters, where it may be presumed that particulate matter of nonplankton origin is minimal. Phytoplankton concentrations are expressed as Harvey units of plant pigments per liter, a type of measurement that will be discussed in the next paper of this series. The extinction coefficients were obtained photometrically in a few cases, but most of the values are converted from Secchi disc readings according to equation (2).

The semilogarithmic plot in Fig. 13A is necessary in order to picture the total range of phytoplankton variations, which encompass more than three orders of magnitude. However, the method of presentation obscures the form of the relationship. Hence the smooth curve that has been fitted to the data is repeated in arithmetic form in Fig. 13B. There it is apparent that, unlike algal cultures, the relation between phytoplankton concentrations and extinction coefficients in the sea is nonlinear.

The smooth curve in Fig. 13 corresponds to the equation

$$K = .04 + 2 \times 10^{-6} P + 2 \times 10^{-4} P^{2/3}, \quad (4)$$

where K is the extinction coefficient and P is Harvey units of plant pigments per cubic meter. The constant in the equation is an average absorption coefficient for visible light in pure water. The terms for plant pigments were derived empirically as a reasonable fit for the data in Fig. 13 and other more recent observations that should be considered in this connection.

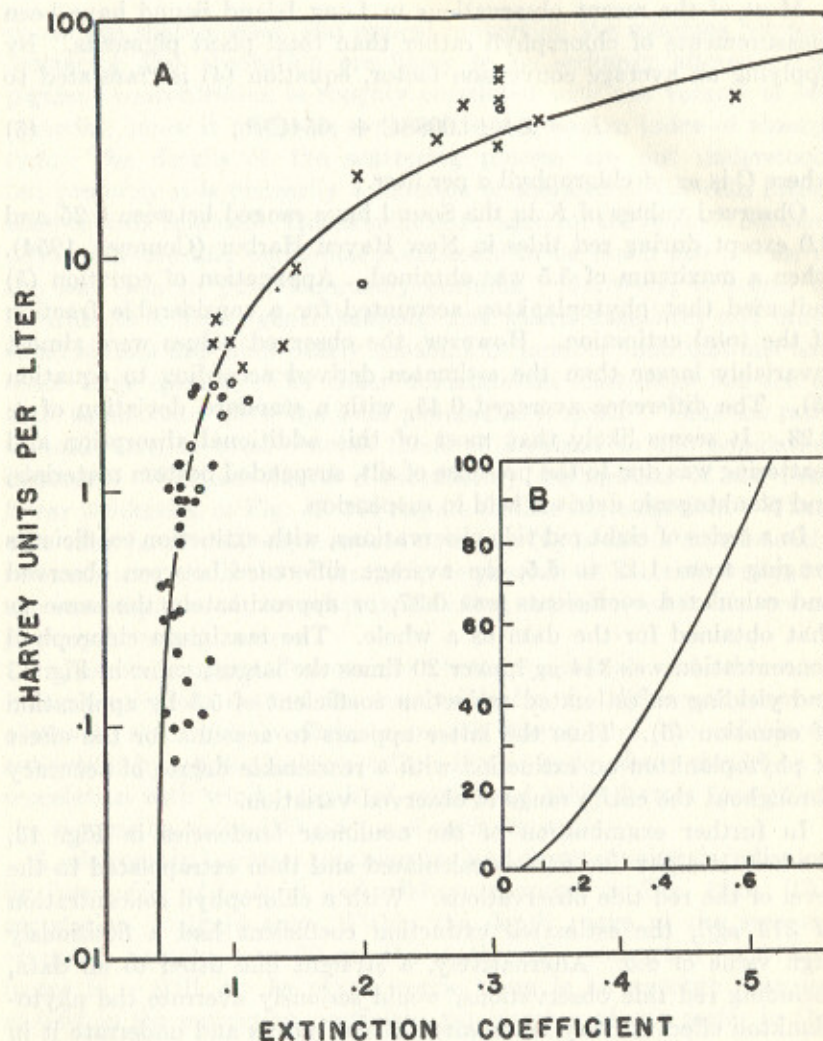

Figure 13. Relationship between extinction coefficients and phytoplankton pigments as determined by the Harvey method (1934). A. Semilogarithmic plot of observations obtained in the Sargasso Sea (dots), continental slope waters off the New England coast (circles), and the spring flowering period of March and April on Georges Bank (x's). B. Arithmetic plot of the smooth curve in Fig. 13A.

Most of the recent observations in Long Island Sound have been measurements of chlorophyll rather than total plant pigments. By applying an average conversion factor, equation (4) is translated to

$$K = .04 + .0088C + .054C^{2/3}, \quad (5)$$

where C is μg of chlorophyll a per liter.

Observed values of K in the Sound have ranged between 0.25 and 2.0 except during red tides in New Haven Harbor (Conover, 1954), when a maximum of 5.5 was obtained. Application of equation (5) indicated that phytoplankton accounted for a considerable fraction of the total extinction. However, the observed values were almost invariably larger than the estimates derived according to equation (5). The difference averaged 0.45, with a standard deviation of ± 0.23 . It seems likely that most of this additional absorption and scattering was due to the presence of silt, suspended bottom materials, and planktonic detritus held in suspension.

In a series of eight red tide observations, with extinction coefficients ranging from 1.12 to 5.5, the average difference between observed and calculated coefficients was 0.37, or approximately the same as that obtained for the data as a whole. The maximum chlorophyll concentration was 314 $\mu\text{g}/\text{l}$, over 20 times the largest value in Fig. 13 and yielding an estimated extinction coefficient of 5.3 by application of equation (5). Thus the latter appears to account for the effect of phytoplankton on extinction with a reasonable degree of accuracy throughout the entire range of observed variation.

In further examination of the nonlinear tendencies in Fig. 13, the best straight line fit was calculated and then extrapolated to the level of the red tide observations. With a chlorophyll concentration of 314 $\mu\text{g}/\text{l}$, the estimated extinction coefficient had a fictitiously high value of 8.5. Alternatively, a straight line fitted to all data, including red tide observations, would seriously overrate the phytoplankton effect in very transparent ocean waters and underrate it in waters with moderately high extinction coefficients of 0.5 to 1.0.

There remains the question of the reason for differences between natural phytoplankton populations and pure algal cultures. In the latter, both scattering and absorption are expected to be proportional to cell number, so that the results approximate Beer's law, although the process is much more complicated than in the case of materials in solution. In a mixed phytoplankton population containing cells

of various shapes, sizes, and optical properties, the relations between scattering and absorption are likely to be seriously altered. The pigment concentration is roughly correlated with the volume of cell material; hence it might be expected to serve as an index of absorption. The details of the scattering process are not understood, but probably it is primarily a function of the area of the cells rather than of their volume. This is sufficient reason for the relation between phytoplankton and extinction coefficients to be much less precise in the sea than in pure laboratory cultures. Moreover, it seems to be true, as a broad generalization, that naked flagellates and other small species are more nearly constant in number than diatoms and other large species. The latter dominate the flowerings but are of little significance when the total population is small. Thus the ratio of total area to total volume tends to decrease as the population increases. Whether this is a satisfactory explanation of the nonlinear tendencies in Fig. 13 will require further investigation. Whatever may be the full explanation, equation (6) presents a sufficiently accurate account of the relationship to provide an entering wedge for the investigation of the other factors that are involved in the transparency of coastal waters.

It has been suggested above that bottom materials and other non-living particulate matter are responsible for the difference between observed extinction coefficients in the Sound and the calculated extinction by phytoplankton cells. If this is so, there should be a correlation with winds, depth of water, and other factors that affect the suspension and settling rates of such materials.

A relationship between transparency and depth of water is indicated by inspection of inshore and offshore averages in Fig. 12B. The correlation is significant. Within the depth range of the stations occupied, namely 4 to 30 m, the statistically computed correction factor is $-0.01 d$. In other words, there is an average decrease of 0.01 in the extinction coefficient per increase of one meter in the depth of the station. The computation makes due allowance for differences in phytoplankton concentration and thus it is intended to express the relation between depth and non-living suspended matter.

At certain stations the occurrence of surface eddies of reduced salinity coincided with low Secchi disc readings. There is no doubt that silt effects are appreciable in the Sound. However, the obvious effects in the central basin are of limited area, and general correlations with recent rainfall are too low to warrant inclusion in the analysis.

In considering the effects of wind, it was apparent that transient storms might reduce the transparency materially, while the average wind speed over a longer period might also be important in controlling the suspension of fine materials. In investigating this problem, the mean wind speed was tabulated for the day of observation as well as the preceding day, the preceding week, and month. The means were then correlated with a residual extinction coefficient, obtained by removing the chlorophyll and depth effects from the observed extinction coefficients and averaging the residuals for each of the 96 days of observation. All correlations were statistically significant. The mean wind during the preceding week yielded the highest correlation and was adopted for subsequent analysis.

It is expected that the stirring action of the wind will be materially reduced by vertical stability. Using the difference between bottom and surface density as a rough expression of stability, it was possible to demonstrate a small but significant negative correlation with residual extinction coefficients. However, to be satisfactory from the physical oceanographic point of view, wind and stability should be combined into a single expression which recognizes the existence of a stirring effect in water of indifferent stability and a gradual reduction of that effect with increasing stability. Development of such an expression would be facilitated by a more precise knowledge of the nature of the physical relationship. Alternatively, by trial and error and using statistical methods to test the results, it was possible to formulate an expression that was empirically satisfactory but not necessarily correct from a physical standpoint. It was $.018 W/.3 + \Delta\sigma_t$, where W is the mean wind speed in miles per hour during the week preceding the observation, $\Delta\sigma_t$ the mean increase in density from surface to bottom at the beginning and end of the week.

Tidal currents also presumably affect transparency in shallow coastal waters. Mean tidal currents have been computed from data on tidal height in the Sound (Riley, 1952). In the central region the current speed is 19 cm/sec., averaged through a complete tidal cycle at a time of average tidal height. The total variation between lowest neaps and highest spring tides is about 13 to 28 cm/sec. Tidal currents, estimated from the predicted height of the tide for the two-year period of the investigation were averaged by weeks. There was a significant correlation between residual transparency and the

mean current speed during the preceding week, and the average effect was computed to be $.013 v$, where v is the average current in centimeters per second. There was no evidence that the tidal factor was significantly modified by variations in vertical stability, although observations at current stations suggested that stability has a slight effect on the vertical velocity gradient.

Finally, inspection of the data indicated an increase in residual extinction coefficients during the summer months which could not be accounted for by any of the variables thus far examined. Two possible explanations may be offered. First, there is a seasonal variation in the ratio of chlorophyll content to phytoplankton organic matter (see the accompanying paper by Harris and Riley), so that chlorophyll may not be entirely acceptable as an index of light extinction by phytoplankton. In the second place, there is evidence, visual and otherwise, of considerable quantities of organic detritus in the water during the summer. Nets are often clogged with slimy brown material containing little recognizable plant substance. It is apparent (see the accompanying paper on PRODUCTION AND UTILIZATION) that a considerable proportion of the spring phytoplankton growth settles to the bottom and is not immediately decomposed. Summer on the other hand is a period of active bacterial growth, accompanied by reduced oxygen in the lower part of the water column and increasing phosphate concentrations. Bacterial activity appears to exceed production, and presumably the excess spring growth is largely decomposed during this period. The bottom appears to be a more important site of decomposition than the water column, but in both cases the intermediate steps in decomposition can be expected to produce light, finely divided material that is easily carried in suspension.

Both of the phenomena that have been described might be expected to influence transparency, although neither can be rated precisely in quantitative terms. Examination of the data shows that the summer increase in residual extinction coefficients is approximately proportional to the oxygen deficit, defining the latter as the percent undersaturation of the bottom water or the percent difference between surface and bottom when the surface layer is undersaturated. It is statistically justifiable to use the oxygen deficit in the analysis, but with some reservations as to the meaning and validity of the term.

The final form of the equation may now be written

$$K = f(C) - .01d + .018 \frac{W}{.3 + \Delta\sigma_t} + .013v + .0063f(O_2) + .05. \quad (6)$$

The chlorophyll relationship in equation (5), but not including the constant, is specified $f(C)$, and the percentage deficit of oxygen that has just been described is written $f(O_2)$. Other factors have been sufficiently described above. The final constant is statistically derived. It differs little from the absorption coefficient for pure water, but the form of the equation is such that this fact has little significance.

DISCUSSION

Fig. 14A compares observed and calculated extinction coefficients, and Fig. 14B shows the seasonal variation in the individual components of equation (6). There is a correlation of 0.66 between observed and calculated values. The correlation is highly significant statistically but not very precise by absolute standards. The general seasonal trend of the calculated curve is realistic, but short period fluctuations show considerable error. Perhaps the agreement would have been closer if a more accurate method had been used to measure transparency. Other random errors undoubtedly result from local variability in density, oxygen, etc. Observations at five stations can hardly be expected to give typical, average values for the region on a particular date.

In particular cases there are readily observable reasons for disagreement. For example, on January 27 and December 16, 1953, the observed extinction coefficients exceeded the calculated ones by about 0.50. Both sets of observations were preceded by heavy northwest storms. In both cases it was only the northern inshore stations that were seriously affected. In other words, immediate wind effects can be more important than is indicated by general statistical comparison. However, to fit them into the general equation would require an elaborate treatment of both the speed and direction of the wind in relation to the particular area sampled.

With the possible exception of the phytoplankton treatment, all of the terms in equation (6) are of local significance only. Depth, current, and wind-stability factors presumably are subject to great variation according to the kind of bottom sediments available for suspension. This would introduce an element of empiricism even if the physical oceanographic processes were expressed in a fully

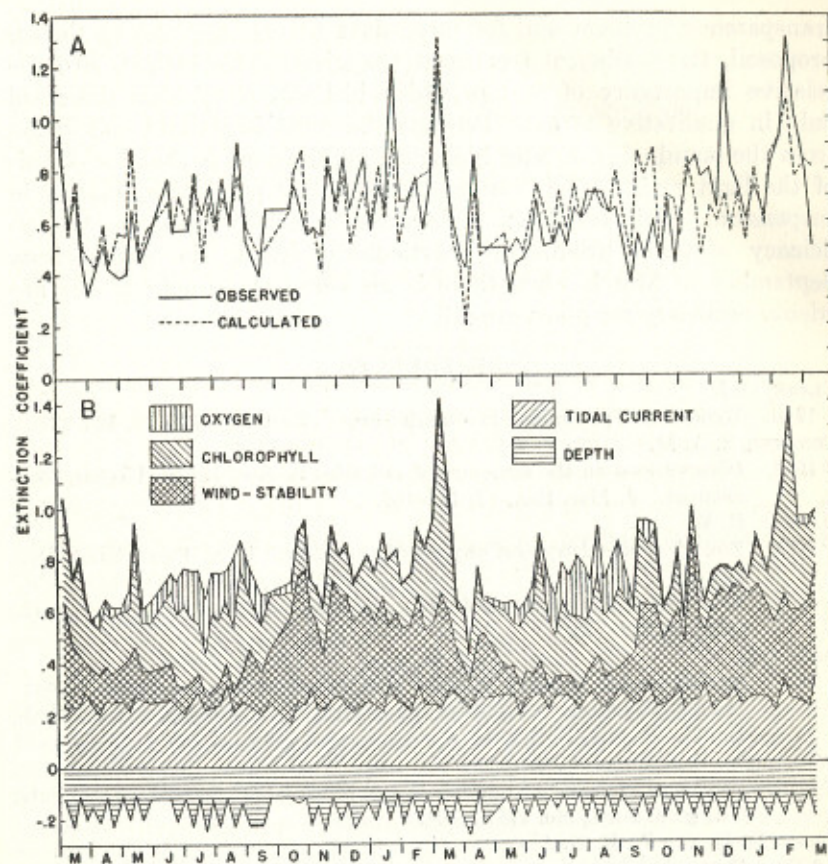

Figure 14. A. Comparison of weekly averages of the observed extinction coefficients in central Long Island Sound with average values calculated from equation (6). B. Relative importance of the individual components in equation (6). Positive factors are plotted one above the other. Thus the uppermost curve represents the sum of all four positive factors, and the calculated extinction coefficient is the uppermost curve minus the depth correction.

acceptable manner. A revision of the analysis may be desirable when the remainder of the survey has been completed. The latter will increase the total depth range to 100 m and hence will provide a better set of data for testing nonlinear characteristics or possible combination with other factors, and will also permit examination of a wider variety of tidal velocities, bottom sediments, and drainage conditions.

Despite the need for a better theoretical understanding of the

transparency problem and for more data to test any theory that is proposed, the statistical treatment has given some insight into the relative importance of factors which hitherto have been discussed only in qualitative terms. Perhaps the most important conclusion from the standpoint of later biological applications is that two-thirds of the light extinction is caused by nonliving particulate matter in suspension. This condition must have a serious effect on the efficiency of plant production, particularly during the period from September to March when there is an abundant supply of the nutrients necessary for plant growth.

REFERENCES

- CLARK, G. L.
1946. Dynamics of production in a marine area. *Ecol. Monogr.*, 16: 323-335.
- CONOVER, S. A. M.
1954. Observations on the structure of red tides in New Haven Harbor, Connecticut. *J. Mar. Res.*, 13: 145-155.
- HARVEY, H. W.
1928. Biological chemistry and physics of sea water. Univ. Press, Cambridge. 194 pp.
1934. Measurement of phytoplankton population. *J. Mar. biol. Ass. U. K.*, (NS) 19: 761-773.
- JERLOV, N. G.
1951. Optical studies of ocean waters. Rep. Swedish Deep-sea Exped. 1947-1948, 3 (Physics and Chemistry, Fasc. 1): 1-59, Göteborg. VetenskSamh. Handl.
- LELACHEUR, E. A. AND J. C. SAMMONS
1932. Tides and currents in Long Island and Block Island Sounds. *Spec. Publ. Cst. geod. Surv.*, No. 174: 1-184.
- POOLE, H. H. AND W. R. G. ATKINS
1929. Photo-electric measurements of submarine illumination throughout the year. *J. Mar. biol. Ass. U. K.*, (NS) 16: 297-324.
- PRITCHARD, D. W.
1952. Salinity distribution and circulation in the Chesapeake Bay estuarine system. *J. Mar. Res.*, 11: 106-123.
- PRITCHARD, D. W. AND W. V. BURT
1951. An inexpensive and rapid technique for obtaining current profiles in estuarine waters. *J. Mar. Res.*, 10: 180-189.
- RILEY, G. A.
1951. Parameters of turbulence in the sea. *J. Mar. Res.*, 10: 247-256.
1952. Hydrography of the Long Island and Block Island Sounds. *Bull. Bingham oceanogr. Coll.*, 13 (3): 5-39.
- RODHE, WILHELM
1948. Environmental requirements of fresh-water plankton algae. *Symb. bot. upsaliens.*, 10 (1): 1-149.

OCEANOGRAPHY OF LONG ISLAND SOUND, 1952-1954

III. CHEMICAL OCEANOGRAPHY

By

GORDON A. RILEY

AND

SHIRLEY A. MACMILLAN CONOVER

Bingham Oceanographic Laboratory

TABLE OF CONTENTS

ABSTRACT.....	47
METHODS.....	47
SEASONAL CYCLES IN THE CENTRAL PART OF THE SOUND....	50
HORIZONTAL DISTRIBUTION.....	55
REFERENCES.....	61

ABSTRACT

Nitrate is virtually absent from the water column from the end of the spring flowering until the following September; a gradual increase follows, culminating in a midwinter maximum of some 20 $\mu\text{g-at N/l}$. The phosphate concentration is about 0.5 $\mu\text{g-at P/l}$ at the end of the spring flowering, declines a little more during the spring months, then increases slowly through the summer and more sharply in autumn. Even in midwinter, the N:P ratio is only about 8:1. Oxygen is reduced in the bottom waters in summer, with minimum concentrations of about 50% saturation. Data on the chlorophyll content of phytoplankton and on the displacement volume of zooplankton are included for comparison with chemical cycles. The available information on the horizontal distribution of phosphate, nitrate, and chlorophyll is examined. It is postulated that the two-layered transport system in the Sound provides a mechanism whereby plant growth and accompanying positive gradients in nutrients automatically lead to retention of nutrients within the Sound and regulate the supply at a slightly higher level than that in adjacent oceanic waters.

METHODS

Oxygen was determined by the Winkler method. Prepared samples of 100 ml were titrated with thiosulfate of a strength such that the titer approximated milliliters of oxygen per liter in the sample. The thiosulfate was standardized with potassium dichromate.

The Atkins-Denigès method was used for inorganic phosphate. The sulphuric acid and ammonium molybdate, stored separately, were mixed just prior to use. Stannous chloride was freshly prepared for each set of analyses. The color was measured in a Klett-Sumner photoelectric colorimeter, using a No. 66 filter and a 40 mm cell. Suitable corrections were made for reagent blank, turbidity in the seawater sample, and salt error. Measurements were generally made on the day following collection of the samples. This delay conceivably introduced some error into the determinations. Riley (1941) reported a series of 65 experiments on changes occurring in phosphate and other nonconservative elements in Long Island Sound water stored in light and dark bottles for periods of three or four days. There was an average decrease of 0.10 $\mu\text{g-at P/l}$ in a day's time in the light bottles and an increase of 0.05 $\mu\text{g-at}$ in the dark. Possible errors of this magnitude in the results reported below would not seriously alter the conclusions.

Nitrate analyses during the first year were carried out according to the strichnidine method described by Zwicker and Robinson (1944). Subsequently the amount of strichnidine in the sulfuric acid was reduced to one-half, following a recommendation by Francis A. Richards (personal communication). Measurements were made on the Klett, with 12 mm diameter tubes and a No. 54 filter. Differences in replicates and in successive standardization curves indicate an analytical error of at least $\pm 10\%$. In addition, there is probably a small systematic error, since it has been common in spring and summer to find seawater readings that are slightly lower than the blanks.

Material for plant pigment determinations was obtained by filtering a citrate bottle (375 ml) of sea water through a No. 42 Whatman filter paper immediately after collection of the sample. The filter paper was put in 90% acetone for 16 to 24 hours, and the extract was then refiltered to remove any particles in suspension. The volume was adjusted to 5 ml, and the Klett readings were made with 12 mm tubes and a No. 66 filter.

Filtration was carried out with light suction to minimize loss of phytoplankton through the filter. Ordinarily half an hour to an hour was required to filter each sample; a shipboard battery of six filter holders was sufficient to carry out the operation. To obtain an analysis with only 375 ml is feasible in the rich waters of Long

Island Sound provided considerable care is taken in colorimetric readings. Larger samples tended to clog the filters.

On two occasions, comparative measurements have been made with millipore filters having a pore size of about 0.5 μ . During the spring flowering of 1954, aliquot samples were poured through the two types of filters. No significant difference was detected. On a later occasion, when the total crop was smaller and when the proportion of small cells had increased, the test was repeated more carefully. The filtrate from four paper-filtered samples was caught and passed through a millipore filter. The phytoplankton that passed through the paper and was retained by the millipore filter gave a reading of 0.14 $\mu\text{g chlorophyll } a/l$, as compared with an average of 2.1 μg in the paper-filtered samples. Further examinations are needed, but at the present time it appears that the loss of phytoplankton through the paper filters is a relatively insignificant fraction of the total population.

The plant pigment readings were recorded as the colorimetric equivalent of chlorophyll *a* in $\mu\text{g per liter}$, although it is presumed that other pigments have some slight effect on total extinction. The method was standardized with the aid of a crude chlorophyll concentrate which was obtained from the American Chlorophyll Division of Strong, Cobb, and Co. and which contained by analysis 13.2% chlorophyll *a* and 3.9% chlorophyll *b*. Weighed samples of the concentrate were dissolved in 100% acetone, and successive dilutions in 90% acetone were measured on the Klett. Data by Edmondson and Edmondson (1947) on the absorption characteristics of chlorophyll *a* and *b* and of the Klett 66 filter indicate that the chlorophyll *a* in the samples was responsible for 89.1% of the total extinction. The calibration curves were corrected accordingly.

On several occasions duplicate measurements have been made on phytoplankton pigment extracts using the method described above as well as visual colorimetric comparison with the Harvey (1934) plant pigment standard. Results are shown in Fig. 1. On the average, 1 μg of chlorophyll is equivalent to 4.4 Harvey units, and the general relationship throughout the range of concentrations examined is sufficiently accurate to permit comparison of present results with previous analyses by the Harvey method.

Some of the previous work on Long Island Sound and Georges Bank (Riley, 1941, 1941a) has included chlorophyll measurements

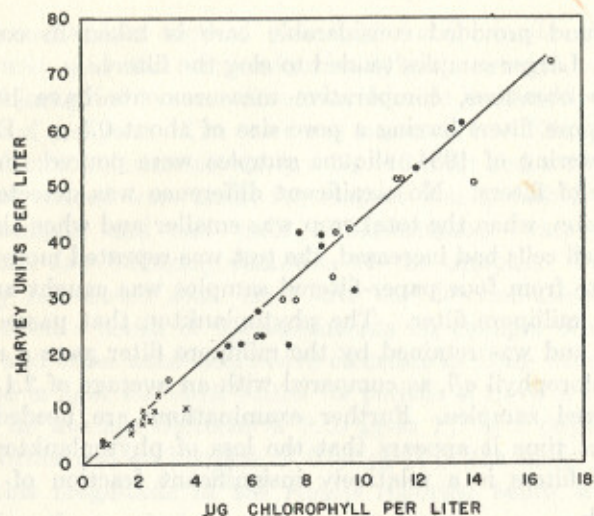

Figure 1. The Harvey (1934) method of plant pigment measurement compared with the chlorophyll method described in the text. Each point represents a measurement by each method of the pigments in an acetone extract of a natural phytoplankton sample from central Long Island Sound. Dots represent samples taken on May 21, 1952; circles, June 11, 1952; x's, October 9, 1952.

in which the carotenoids and chlorophyll were separated by chemical methods, the latter having been measured by visual colorimetry against an arbitrary standard calibrated with a pure chlorophyll preparation. Riley (1941a) listed analyses of 22 samples of net phytoplankton in which $1 \mu\text{g}$ chlorophyll, so determined, was equivalent to 3.9 Harvey units. Somewhat different results were obtained in routine analyses of the total plankton filtered from a liter of sea water. Average ratios in both Long Island Sound (21 unpublished observations) and Georges Bank (Riley, 1941a) were about $1 \mu\text{g}$ chlorophyll to 3 Harvey units. It is possible that there was a significant error in the earlier standardization or, more likely, a tendency to over-read dilute chlorophyll concentrations because of a slight turbidity in the prepared solutions.

SEASONAL CYCLES IN THE CENTRAL PART OF THE SOUND

Figs. 2 and 3 show seasonal cycles of phosphate, nitrate-nitrite, chlorophyll, and total zooplankton displacement volume as averages of inshore and offshore stations, respectively. Discussion of the

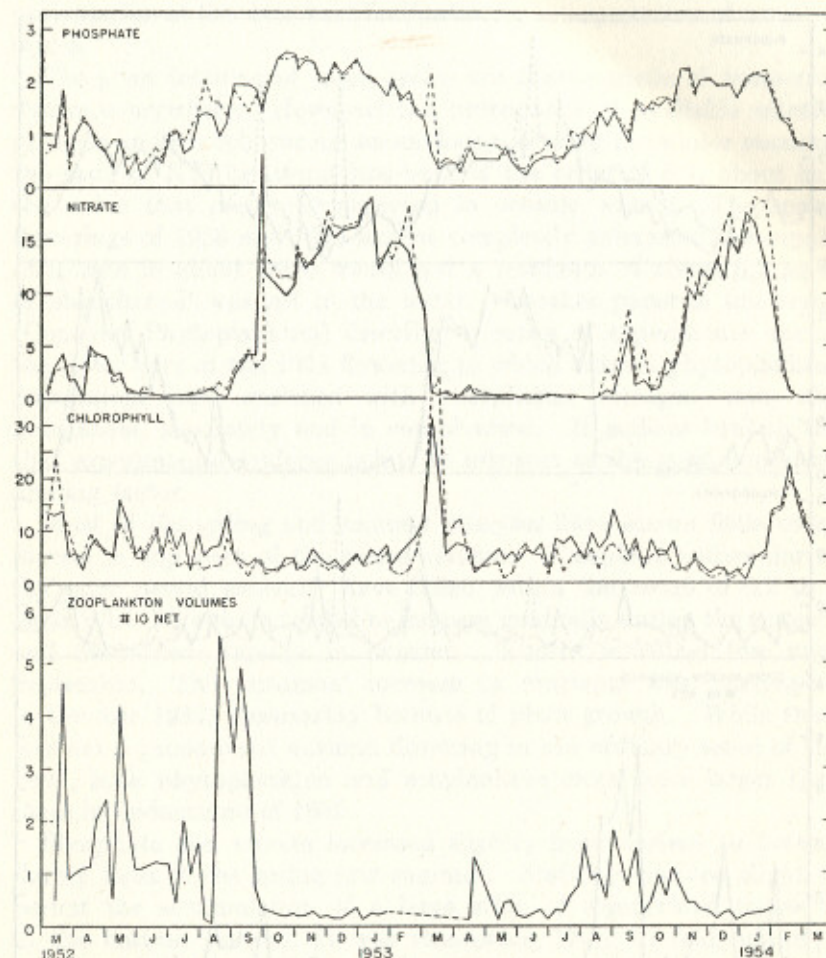

Figure 2. Weekly averages of observations at inshore Sts. 1, 6, 7, and 8. Phosphate and nitrate are plotted as $\mu\text{g-at}$ per liter, chlorophyll as μg per liter. Solid line shows surface averages; broken line, bottom. Zooplankton displacement volumes are plotted as milliliters per cubic meter in an oblique tow from near bottom to surface. During the spring flowering, the zooplankton volume could not be determined because the catch included large quantities of phytoplankton. This period is indicated by a broken line.

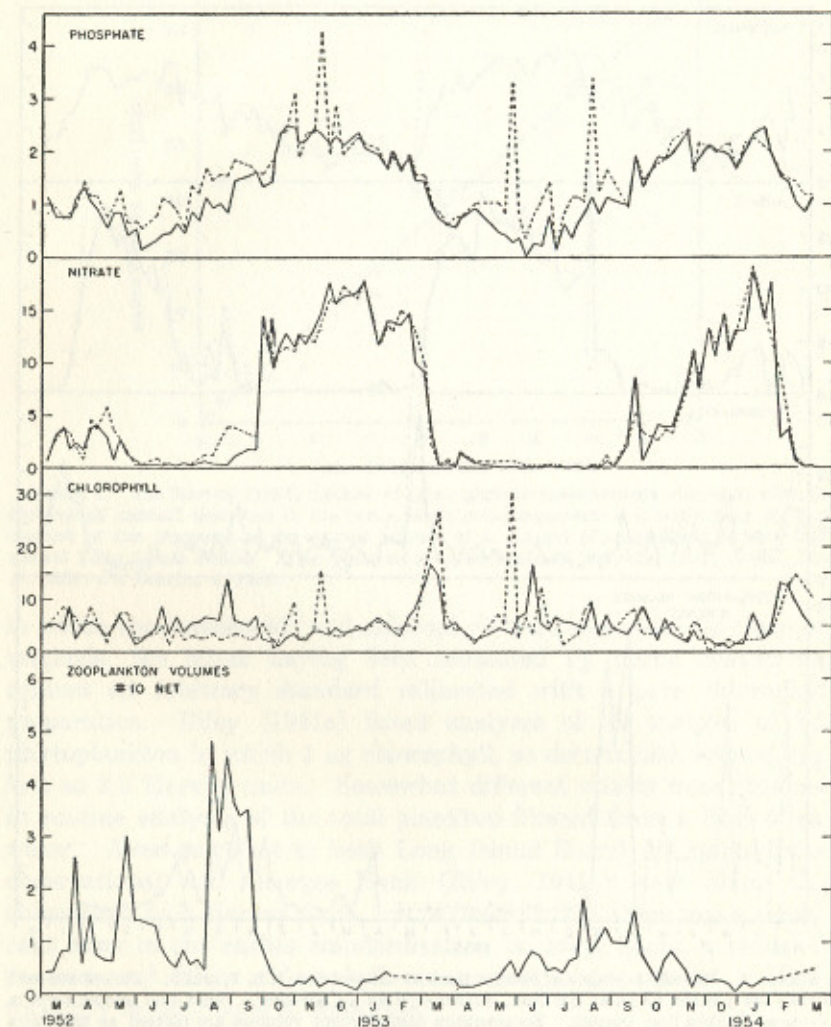

Figure 3. Weekly averages of phosphate, nitrate, chlorophyll, and zooplankton volume at offshore Sts. 2 to 5. Method of plotting as in Fig. 2.

plankton is largely relegated to other papers in this volume, but presentation of the data here facilitates the interpretation of nutrient cycles.

The gross features of these cycles are characteristic of temperate waters everywhere. However, the proportions of available nitrate-nitrogen and phosphorus are anomalous. During the winter maxima, the ratio of N:P by atoms has been of the order of 8:1, about half the value that might be expected in oceanic waters. The spring flowerings of 1953 and 1954 almost completely exhausted the supply of nitrate in about three weeks but a residuum of about $0.5 \mu\text{g-at}$ of phosphate-P was left in the water. Another paper in this series (Conover: Phytoplankton) describes a series of experiments during the latter part of the 1954 flowering in which natural phytoplankton populations were enriched with phosphorus, nitrogen, iron, and manganese, separately and in combination. It suffices here to say that experimental evidence points to nitrogen as the most important limiting factor.

Most of the spring and summer analyses have shown little or no nitrate in any part of the water column. Phosphate values during the same period generally have fallen within the range of 0.2 to $1 \mu\text{g-at P/l}$. Phosphate tended to increase gradually during the summer and then more rapidly in autumn. Nitrate remained low until September. The autumnal increase in nutrients was interrupted in October 1953, presumably because of plant growth. While there was not a pronounced autumn flowering in the ordinary sense of the term, both phytoplankton and zooplankton crops were larger than those in midautumn of 1952.

Phosphate and nitrate increased slightly from surface to bottom during most of the spring and summer. Stability was too slight to permit the accumulation of a large store of regenerated nutrients in the bottom waters. It was reasonable, then, to find neither a pronounced summer period of phytoplankton impoverishment nor a marked flowering following the destruction of the summer thermocline. Slight and variable vertical gradients were observed in autumn and winter. It was fairly common in autumn to find significant decreases in phosphate and nitrate in the bottom waters. Reasons for this peculiar phenomenon will be apparent in the later discussion of horizontal distribution and transport.

Oxygen data are shown in Fig. 4, again as averages of inshore and

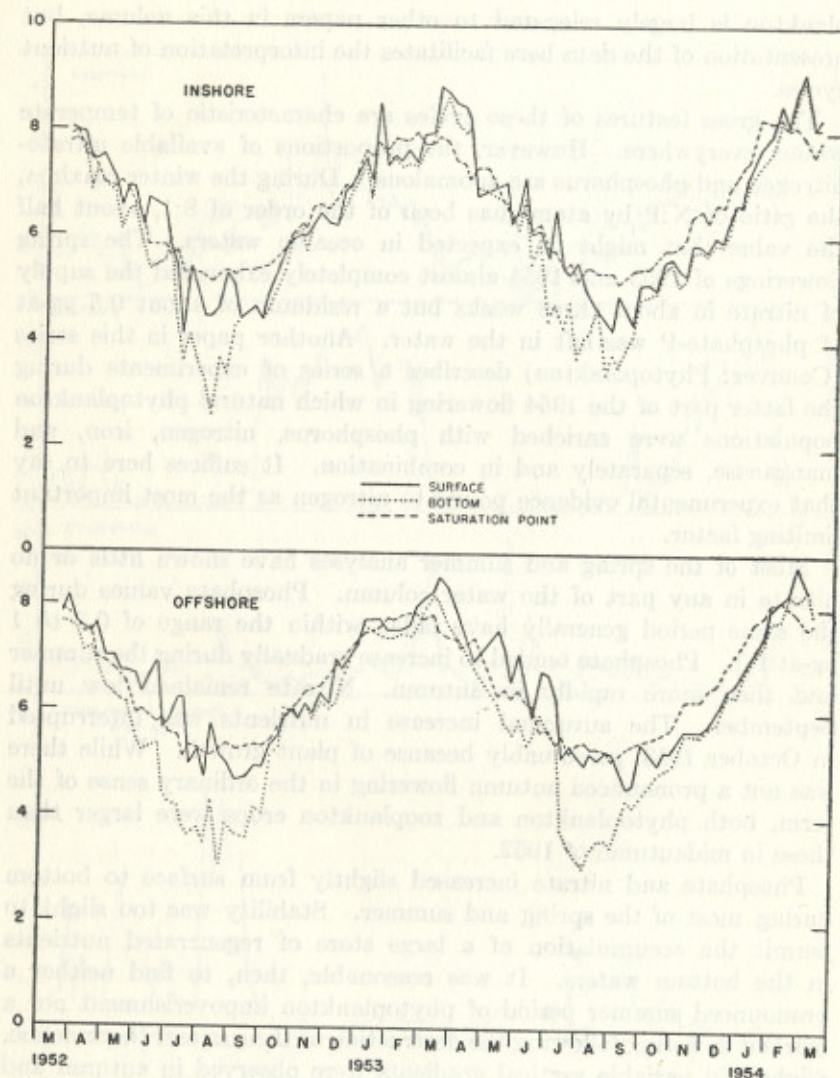

Figure 4. Weekly averages of oxygen concentration in milliliters per liter at inshore and offshore stations. Solid line, surface; dotted line, bottom; broken line, calculated values for 100% saturation at the surface at the observed temperature and salinity.

offshore stations, together with the computed values for 100% saturation at the surface. Supersaturation of the surface layer occurred during the spring flowering and to a lesser extent on various other occasions. The oxygen content of the bottom water declined during the spring and early summer. Minimum values recorded at individual stations were about 50% saturated. Vertical gradients in oxygen were more pronounced than those of phosphate and nitrate. The form of the vertical distribution indicates that maximum oxygen production by phytoplankton occurred between the surface and 5 m and that photosynthesis exceeded utilization of oxygen by the plankton community in the upper 10 or 15 m. However, the nitrate and phosphate gradients suggest considerable utilization of these substances by phytoplankton at depths of 15 m or more.

During autumn and early winter, the oxygen was generally slightly undersaturated from surface to bottom. Three factors are probably involved: (a) a slight lag between surface cooling and oxygen uptake; (b) an acceleration of vertical mixing and convection, which increased the oxygen content of the bottom water and correspondingly lowered the concentration in the remainder of the water column; and (c) an excess of oxidation over production in most of the water mass, as indicated by the autumn increase in nutrients.

HORIZONTAL DISTRIBUTION

While there is a considerable body of previous data on temperature and salinity for the Sound, biological and chemical work has been scanty and has been concerned almost entirely with seasonal cycles in localized areas. The present survey has included an examination of the distribution of oxygen, phosphate, nitrate, and plankton during three cruises that covered most of the Sound. This obviously does not provide an adequate treatment of horizontal distribution, but certain problems are revealed that deserve preliminary mention at this time and which will be studied more intensively during the remainder of the survey.

Fig. 5 shows the distribution of phytoplankton chlorophyll at the surface in June 1952 and in the latter part of September and early October of the same year. During the first cruise there was a general east-west gradient, the maximum concentration in the north-central part of the Sound being some four times the average crop in the

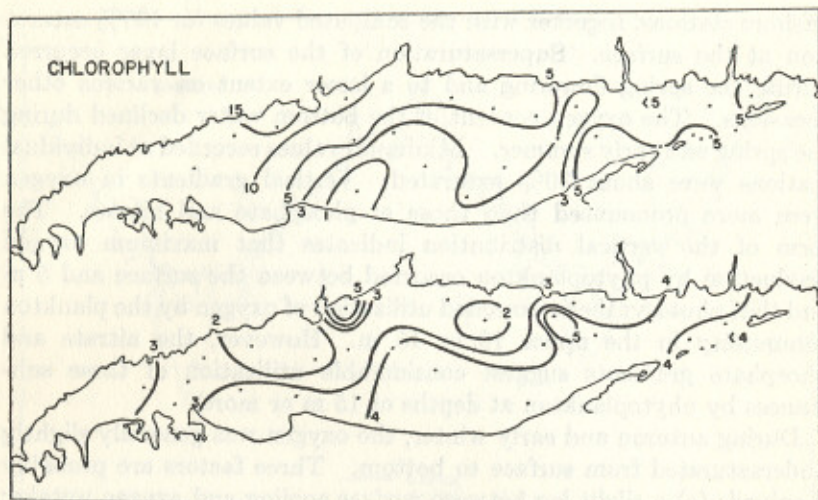

Figure 5. Horizontal distribution of chlorophyll in μg per liter at the surface. Upper figure, June 4 to 11, 1952; lower, Sept. 29 to Oct. 9, 1952.

vicinity of the eastern passes. A similar gradient was found in April 1953 (not figured here). Previous comparison of seasonal cycles in Block Island Sound and in the central part of Long Island Sound (Riley, 1952b) has also indicated a much larger average concentration in the latter. An east-west gradient of the type pictured thus appears to be fairly common, at least during the spring and summer. It was not present during the autumn cruise shown in the lower part of Fig. 5.

With respect to nutrients, the opposite situation obtained. In June 1952 there was a slight east-west gradient in phosphate (Fig. 6) and essentially no nitrate gradient (Fig. 7). In early autumn the gradients were very large. Autumn regeneration of nutrients was well underway in the western end of the Sound. It is not altogether clear whether the east-west gradient represented a difference in the amount of materials available for regeneration or a difference in the time when this phase of the cycle began, or both.

The relation between surface and subsurface nutrients and chlorophyll concentrations is shown in Fig. 8 as a series of longitudinal profiles. During the June cruise, the phosphate concentration generally increased from surface to bottom, as might be expected when the phytoplankton exists in a state of active growth. Maximum nitrate values were found in patches of surface water of reduced

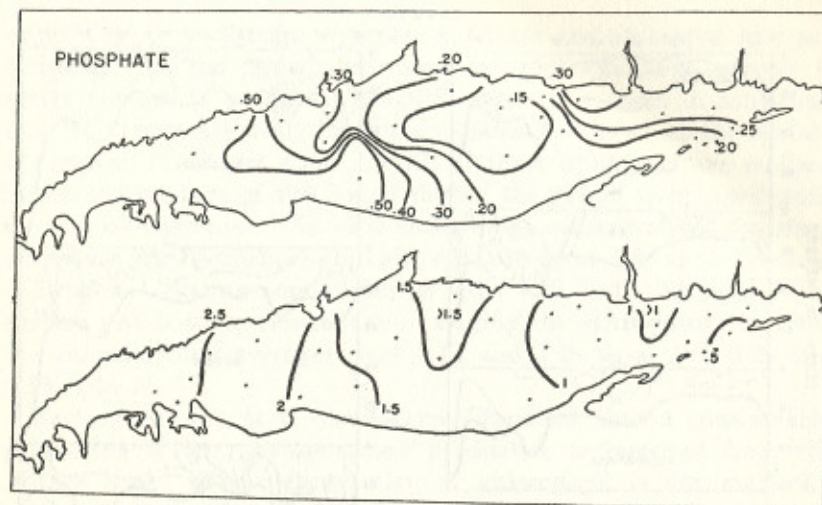

Figure 6. Horizontal distribution of surface phosphate in $\mu\text{g-at}$ per liter. Upper figure, June 4 to 11, 1952; lower, Sept. 29 to Oct. 9, 1952.

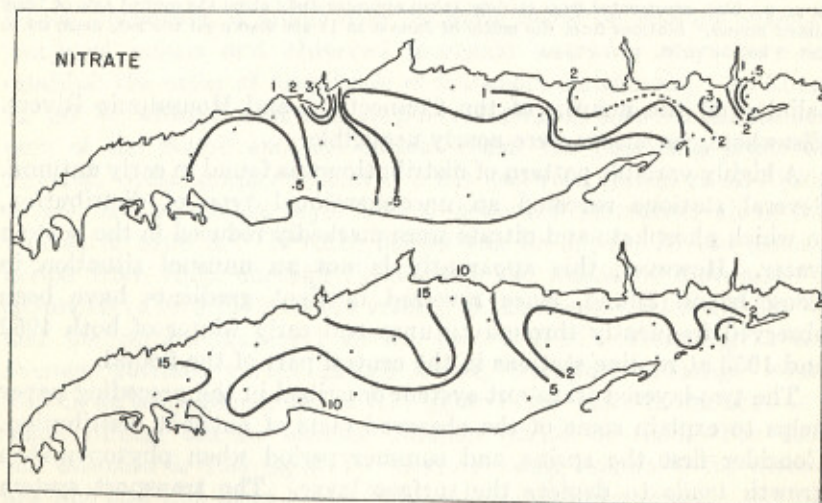

Figure 7. Horizontal distribution of surface nitrate in $\mu\text{g-at}$ per liter. Upper figure, June 4 to 11, 1952; lower, Sept. 29 to Oct. 9, 1952.

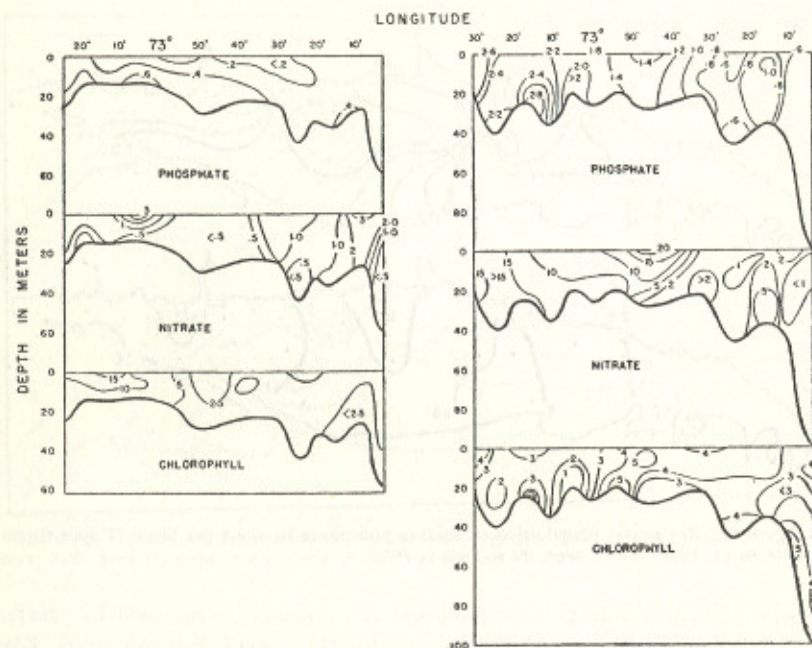

Figure 8. Longitudinal profiles of phosphate and nitrate in $\mu\text{g-at}$ per liter and chlorophyll in μg per liter, constructed from stations taken approximately along the central axis of Long Island Sound. Stations from the cruise of June 4 to 11 are shown on the left, Sept. 29 to Oct. 9 on the right.

salinity off the mouths of the Connecticut and Housatonic Rivers. Elsewhere, variations were nearly negligible.

A highly variable pattern of distribution was found in early autumn. Several stations revealed an unconventional type of distribution, in which phosphate and nitrate were markedly reduced in the bottom water. However, this apparently is not an unusual situation in Long Island Sound, since reversed nutrient gradients have been observed frequently through autumn and early winter of both 1952 and 1953 at routine stations in the central part of the Sound.

The two-layered transport system described in the preceding paper helps to explain some of the observed facts of nutrient distribution. Consider first the spring and summer period when phytoplankton growth tends to deplete the surface layer. The transport system gradually removes the nutrient-poor surface layer. The bottom water that moves in is richer in nutrients. Thus the transport system

establishes a mechanism whereby nutrients are conserved and accumulated in the Sound, provided (a) phytoplankton growth is active enough to produce a positive vertical gradient in nutrients, and (b) a proportion of the phytoplankton produced at the surface is removed to deeper water. Both of these conditions are realized in the central part of the Sound during the period from April until the end of September. In 1952 the average concentration of surface phosphate at the offshore stations was $0.86 \mu\text{g-at P/l}$, at the bottom $1.19 \mu\text{g-at}$. Nitrate concentrations were 1.78 and $2.52 \mu\text{g-at N}$ at surface and bottom, respectively. During the same period in 1953, the corresponding averages were 0.70 and $1.28 \mu\text{g-at P/l}$, 0.29 and $0.63 \mu\text{g-at N}$.

As to point (b), it is qualitatively apparent that a considerable proportion of the phytoplankton production is removed from the surface layer. The concentration of chlorophyll is not markedly greater at the surface than it is at the bottom during the period in question. The presence of a large bottom fauna is sufficient evidence in itself that surface production has been removed to the bottom by one means or another.

An accurate quantitative treatment of this problem awaits further work on both mass transport and nutrient cycles in the Sound as a whole. However, a preliminary estimate based on average summer transport values and observed inorganic nutrients may serve to establish the order of magnitude of transport enrichment. At Long. $72^{\circ} 30' \text{ W}$, which is a convenient point of division between the eastern part of the Sound and the central basin, the preceding paper on Physical Oceanography indicated a net eastward transport of $10,200 \text{ m}^3/\text{sec}$. in the surface layer and a westward movement along the bottom of 9100 m^3 . If these figures can be applied to the general period from April through September, the westward movement is estimated to be 3.10 times the volume of the Sound west of $72^{\circ} 30' \text{ W}$, and the surface transport to the east is 3.46. According to the average nutrient values quoted above, transport exchange would lead to an average increase of $0.71 \mu\text{g-at P/l}$ of water in the area as a whole during the six months' summer period of 1952. For 1953 the estimate is $1.55 \mu\text{g-at P}$. Corresponding estimates for nitrate are 1.65 and $0.96 \mu\text{g-at N/l}$ in 1952 and 1953, respectively.

The final analysis of productivity problems will require not only a revision of the estimates of transport enrichment, with additional

data on ammonia and nutrients in organic combination, but also a consideration of enrichment by freshwater drainage. A few analyses of river water during the spring and summer of 1954 have shown a wide variation in nitrate content, from 0 to 37 $\mu\text{g-at N/l}$. While there is no doubt that drainage has a significant effect with regard to nitrate enrichment, it probably does not exceed the effect of transport exchange. Phosphate concentrations in the rivers are about the same as those in the Sound, and it seems unlikely that drainage materially alters the distribution of this element.

Returning to the problem of transport effects, it is apparent that a two-layered exchange system will result in nutrient accumulation only if phytoplankton growth is sufficiently active to create a vertical gradient in nutrients. If growth is so slight that regeneration exceeds consumption, the accumulation of nutrients is expected to cease, and the direction of nutrient transport may be reversed. In the particular case noted in October 1952, when there were strong east-west gradients in nitrate and phosphate, both lateral diffusion and an eastward transport of the surface layer would tend to move these nutrients out of the Sound. Under such circumstances transport exchange would also be expected to create negative vertical gradients in nutrients. The frequent occurrence of these gradients suggests that loss of nutrients from the Sound during the autumn and early winter is as distinctive a part of the nutrient problem as the accumulation in summer.

In conclusion, the quantitative details of this phenomenon remain to be established, but a general hypothesis is obvious. The two-layered transport system provides a mechanism whereby the biological association automatically regulates the nutrient supply at a slightly higher level than that in the adjacent oceanic waters. Moderate nutrient deficiency accelerates the accumulation, although the system tends to break down when, as in the case of nitrate, severe deficiency depletes the entire water column. An unusable excess of nutrients is automatically dissipated. Both aspects of the phenomenon are conceivably important in maintaining a normal, productive population. Preliminary estimates suggest that the summer accumulation of phosphate by transport exchange constitutes a considerable fraction of the total available store of this element. The accumulation of nitrate by the combined effects of transport and freshwater drainage is relatively less significant. However, no general conclusions about

nitrogen accumulation are warranted until data have been obtained on other nitrogenous compounds.

REFERENCES

- EDMONDSON, W. T. AND Y. H. EDMONDSON
1947. Measurements of production in fertilized salt water. *J. Mar. Res.*, 6: 228-245.
- HARVEY, H. W.
1934. Measurement of phytoplankton population. *J. Mar. biol. Ass. U. K.*, (NS) 19: 761-773.
- RILEY, G. A.
1941. Plankton studies. III. Long Island Sound. *Bull. Bingham oceanogr. Coll.*, 7 (3): 1-93.
1941a. Plankton studies. IV. Georges Bank. *Bull. Bingham oceanogr. Coll.*, 7 (4): 1-73.
1952b. Phytoplankton of Block Island Sound, 1949. *Bull. Bingham oceanogr. Coll.*, 18 (3): 40-64.
- ZWICKER, B. M. G. AND R. J. ROBINSON
1944. The photometric determination of nitrate in sea water with a strychnidine reagent. *J. Mar. Res.*, 5: 214-232.

OCEANOGRAPHY OF LONG ISLAND SOUND, 1952-1954

IV. PHYTOPLANKTON

By

SHIRLEY A. MACMILLAN CONOVER
Bingham Oceanographic Laboratory

TABLE OF CONTENTS

ABSTRACT.....	63
THE ANNUAL CYCLE.....	63
<i>Methods</i>	63
<i>Description</i>	64
<i>Chlorophyll-Cell Count Discrepancies</i>	65
<i>Differences in Annual Phytoplankton Cycles</i>	66
<i>Coefficients of Increase and Decrease of the Standing Crop</i>	66
<i>Vertical Distribution</i>	69
<i>Horizontal Distribution</i>	69
<i>Phytoplankton Composition</i>	71
EXPERIMENTAL STUDIES.....	74
<i>Methods</i>	74
<i>Oxygen Experiments</i>	76
<i>Light Experiments</i>	78
<i>Temperature Experiments</i>	80
<i>Nutrient Experiments</i>	80
SPECIES ACCOUNTS.....	85
MAJOR SPECIES.....	86
Centrate Diatoms.....	86
Pennate Diatoms.....	93
Dinoflagellates.....	95
Silicoflagellates.....	96
Other Forms.....	96
MINOR SPECIES.....	97
Centrate Diatoms.....	97
Pennate Diatoms.....	98
Dinoflagellates.....	99
Silicoflagellates.....	101
Coccolithophores.....	101
Other Forms.....	101

PHYTOPLANKTON ASSOCIATIONS.....	101
ENVIRONMENTAL CONDITIONS AND THE ANNUAL CYCLE.....	103
<i>Midwinter</i>	104
<i>The Flowering Period</i>	104
<i>Spring and Summer</i>	107
<i>Autumn and Early Winter</i>	108
ACKNOWLEDGMENTS.....	110
REFERENCES CITED.....	111

ABSTRACT

The annual phytoplankton cycle in Long Island Sound has been considered from the standpoint of changes in the total population as estimated by cell counts and chlorophyll values, from the behavior of major taxonomic groups, and from seasonal variations in the abundance of individual species. Phytoplankton data have been correlated with environmental factors, and experimental work was undertaken to provide additional information about the physiology of the organisms and to test conclusions drawn from field data.

The annual cycle was characterized by a large late-winter flowering, lower numbers throughout spring and summer, small sporadic flowerings in summer and early fall, and minimal populations in late fall and early winter. Light and turbulence were the critical factors that determined population size in fall and winter. From the termination of the spring flowering until the breakdown of stability in late summer, nutrient supplies were the controlling factors; nitrogen appeared to be the most important limiting nutrient. Grazing may also have had some influence on the size of the summer populations. Turbulence was sufficient to maintain a nearly homogeneous vertical distribution. Although there was a difference in population numbers per unit volume of water between inshore and offshore waters, events in the phytoplankton cycle occurred at about the same time in both areas.

The population was dominated by diatoms except in summer, when dinoflagellates and probably other smaller flagellates largely replaced the diatoms. There was a clear-cut species succession, but environmental differences influenced the relative importance of certain species from year to year. Several examples of the way in which the environment controlled species abundance were afforded by this study. The importance of the physiological state of the natural population has been demonstrated experimentally.

THE ANNUAL CYCLE

Methods. Two types of analyses were employed to describe the quantity of phytoplankton, namely, estimation of chlorophyll *a*¹ and

¹Rabinowitch (1952) described chlorophyll *a* as the ultimate photosynthetic pigment. That is, the accessory pigments of the plant cell may absorb light energy, but only chlorophyll *a* can convert this light energy to useable chemical energy. Consequently, the abundance of chlorophyll *a* ultimately determines the amount of photosynthesis.

cell counts. Samples were collected at weekly intervals at each of the stations visited from March 1952 through March 1954. Water for chlorophyll determination was taken from several depths and was analyzed using the method described by Riley and Conover in this volume. Samples for direct counts were taken at only the one-meter level except at St. 2, where proportional aliquots from each of the four or five depths were combined to give one composite sample. 225 ml of water were preserved with 25 ml of neutral formalin. The samples were allowed to settle for at least 48 hours and were then concentrated by siphoning off the supernatant liquid. The sample was transferred to a vial and the settling and concentration process was repeated. The concentrated sample was counted in a haemocytometer.

Certain objections have been raised to this counting method. Formalin preservation is inadequate for certain types of phytoplankton, particularly the small naked flagellates. Consequently this was probably a serious source of error in the summer samples. Also, there is the possibility that some of the sample was lost when the supernatant liquid was drawn off. However, when the supernatants from different samples obtained during periods of active growth were passed through a millipore filter and the latter was cleared for microscopic examination, the error was found to be less than 0.2%.

Description. From mid-December or early January, a steady increase in the phytoplankton population took place (Fig. 1). The climax of the flowering, the annual maximum, came after three weeks of rapid increase in early March 1953 and in mid-February 1954. After the climax was passed, the population decreased rapidly. Within a month it had passed through the period of decay that follows the flowering and had entered the spring and summer phase. The warmer months were characterized by small oscillations in abundance. A fall flowering was observed in the second year of the survey but not in the first. The annual minimum occurred sometime in the fall, and small populations were recorded throughout late fall and early winter.

The phytoplankton cycle as found in Long Island Sound is not unique. Late winter flowerings in temperate waters have been recorded in similar semiprotected areas. In New England waters, Bigelow, *et al.* (1940) found that the spring flowering commenced earlier in the partially protected bays than in the open waters of the Gulf of Maine. Fish (1925) and Bigelow (1926) reported that it

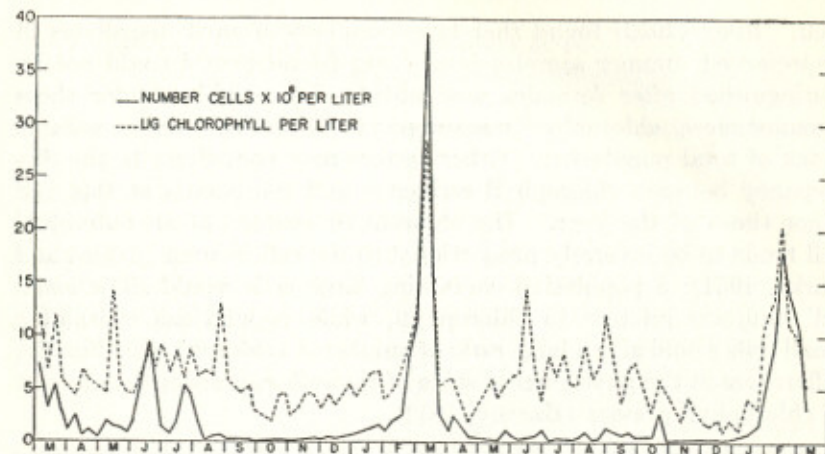

FIGURE 1. Phytoplankton cell numbers and chlorophyll, average surface values for all stations.

occurred even earlier in the shallow semienclosed bays of Cape Cod than in Long Island Sound. Records of similar observations along the Norwegian coast have been briefly summarized by Braarud, *et al.* (1953), and Steemann-Nielsen (1937) found the same pattern in waters around Denmark. The vernal flowering occurs later in British waters near Plymouth than in the more northern but more protected Scandinavian waters (Harvey, *et al.*, 1935). As in Long Island Sound, spring and summer populations in these areas were significantly smaller than in the vernal flowering. Atkins and Jenkins (1953) found an annual chlorophyll minimum in June at the Eddystone station off Plymouth, England. In Long Island Sound, the fall flowering was observed in late September and October. A small September phytoplankton peak was found at the Eddystone by Atkins and Jenkins (1953), but in an earlier study by Harvey, *et al.* (1935) in the same region, the late summer-early fall peaks were larger and one occurred later. A small September peak was found in the North Sea by Grøntved (1952). In winter all of these waters were characterized by small populations.

Chlorophyll-Cell Count Discrepancies. The data on the amount of chlorophyll and cell numbers paralleled each other reasonably well except in summer, when the chlorophyll values were significantly higher than the cell counts (Fig. 1). As was mentioned above, formalin does not preserve all segments of the plant population equally

well. Riley (1952) found that large numbers of small flagellates in unpreserved summer samples from Long Island Sound could not be distinguished after formalin was added. Presumably, under these circumstances, chlorophyll measurements would be a more reliable index of total population. Other factors may contribute to the discrepancy between chlorophyll estimates and cell counts at this and other times of the year. The chlorophyll content of an individual cell tends to be inversely proportional to the cell volume (Atkins and Parke, 1951); a population containing large cells would show small cell numbers relative to chlorophyll, while populations containing small cells would give a large ratio of numbers to chlorophyll. Finally, differences in the physiological state of the cells can affect the amount of chlorophyll present (Harvey, 1953).

Differences in Annual Phytoplankton Cycles. The spring flowering in 1954 was three weeks earlier than that in 1953. Fig. 1 and Table I show that cell numbers from the climax of the spring flowering through August were considerably greater in 1952 than in 1953; the same trend of differences, though less pronounced, was shown by the chlorophyll data. In 1953 a small flowering occurred in September and October, while in 1952 the lowest phytoplankton concentrations for the year were found in this period. Possible explanations for these differences will be considered when the population structure and the environment are discussed later.

Coefficients of Increase and Decrease of the Standing Crop. Weekly phytoplankton estimates can be used to calculate a coefficient K , which measures the relative rate of increase or decrease of the standing crop. An increase in the population may result from increased growth rates, decreased grazing rates, a decrease in the rate of loss by turbulence, introduction of a more concentrated population from another area, or any combination of these circumstances. A decrease in the standing crop may result from the converse of these conditions. K was calculated for both chlorophyll and cell numbers by using the following equation:

$$\ln P_t - \ln P_0 = Kt, \quad (1)$$

where P_0 is the initial population, P_t the population at time t . K values are plotted in Fig. 2.

The values of the coefficients during the spring flowering did not exceed those found at other times of the year, but there was a sustained

TABLE I. MONTHLY MEANS.

Month	Estimated radiation, g cal/cm ² /day								
	Surface			1 meter			5 meters		
	1952	1953	1954	1952	1953	1954	1952	1953	1954
Jan.	—	121	125	—	58	67	—	4	4
Feb.	—	251	186	—	122	83	—	7	2
March	321	253	(259)	194	113	(199)	26	6	(23)
April	401	345	—	262	242	—	48	40	—
May	480	440	—	299	288	—	50	58	—
June	530	651	—	284	389	—	24	48	—
July	623	608	—	319	314	—	27	30	—
Aug.	480	519	—	231	271	—	15	19	—
Sept.	422	446	—	254	267	—	34	43	—
Oct.	336	327	—	161	155	—	13	19	—
Nov.	171	177	—	88	77	—	9	3	—
Dec.	126	140	—	60	60	—	3	3	—
	Surface Temperature, °C			Phosphate P, µg-at/l			Nitrate N, µg-at/l		
Month	1952	1953	1954	1952	1953	1954	1952	1953	1954
Jan.	—	3.97	3.08	—	1.92	2.21	—	14.6	15.1
Feb.	—	3.11	1.68	—	1.69	1.41	—	13.5	4.0
March	3.11	3.93	(3.59)	0.99	0.82	(0.94)	2.1	2.74	(0.08)
April	6.68	6.80	—	1.09	0.61	—	3.0	0.44	—
May	10.87	13.01	—	0.64	0.47	—	1.8	0.20	—
June	17.30	16.02	—	0.39	0.41	—	0.3	0.08	—
July	21.22	21.33	—	0.85	0.62	—	0.31	0.17	—
Aug.	22.80	21.73	—	1.15	1.14	—	0.50	0.21	—
Sept.	21.41	21.48	—	1.58	1.29	—	2.32	1.68	—
Oct.	15.52	17.31	—	2.50	1.82	—	10.4	3.62	—
Nov.	11.77	12.33	—	2.28	2.07	—	13.7	8.9	—
Dec.	7.39	8.57	—	2.35	1.93	—	16.3	12.0	—
	Chlorophyll, µg/l			Cell numbers × 10 ⁶ /l					
Month	1952	1953	1954	1952	1953	1954			
Jan.	—	5.8	2.9	—	1296	969			
Feb.	—	8.2	14.2	—	3422	11347			
March	9.0	15.4	(7.5)	4754	17216	(6936)			
April	5.6	4.6	—	1333	1405	—			
May	6.9	5.1	—	1244	511	—			
June	7.0	7.6	—	5836	641	—			
July	7.7	7.0	—	2822	309	—			
Aug.	8.1	7.0	—	826	495	—			
Sept.	4.7	7.8	—	233	900	—			
Oct.	3.6	4.5	—	197	1127	—			
Nov.	3.7	3.0	—	269	239	—			
Dec.	4.2	1.8	—	442	269	—			

period of positive values at that time. The vernal flowering apparently resulted from conditions that were favorable to steady growth with population accumulation rather than from a sudden change in the physiological state of the phytoplankton with a resultant increase in growth rate. Note that the highest spring flowering values of K occurred at irregular intervals during the flowering period.

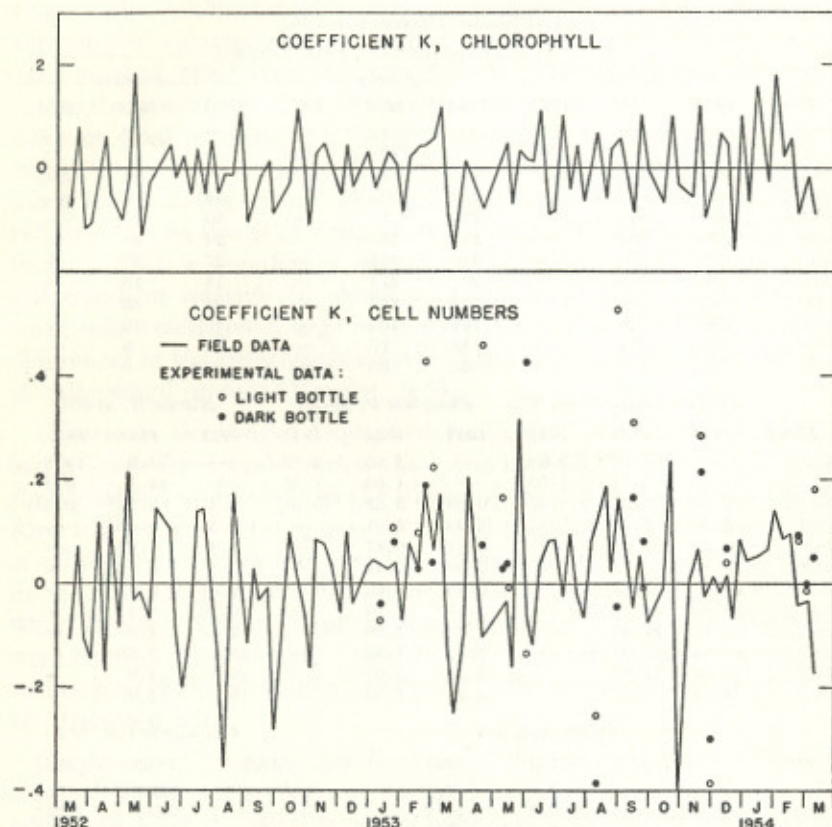

FIGURE 2. Coefficients K, based on cell numbers and chlorophyll; average surface values for all stations.

The natural population did not necessarily follow the classical logistic growth curve demonstrated for laboratory cultures. In the post-flowering period, the negative coefficients were larger than the positive values found during the flowering development. Fluctuation between positive and negative values was characteristic of the spring and summer months, but a greater number of positive values were recorded in 1952 than in 1953. The values of the coefficients for the two years reflected differences in the early fall cycles; in 1952 K values were largely negative, while in 1953 a distinct positive trend was observed from August through October. Late fall and early winter coefficients showed small fluctuations about zero (Fig. 2), indicating

that the population was merely maintained. The first stages of the spring flowering were indicated by the predominantly positive values of K in January.

Vertical Distribution. Unlike the deeper and more exposed southern New England waters such as Block Island Sound (Riley, 1952), concentrations of phytoplankton in the shallow and turbulent waters of Long Island Sound were fairly uniform from surface to bottom (Fig. 3). At times, particularly during active growth, there were

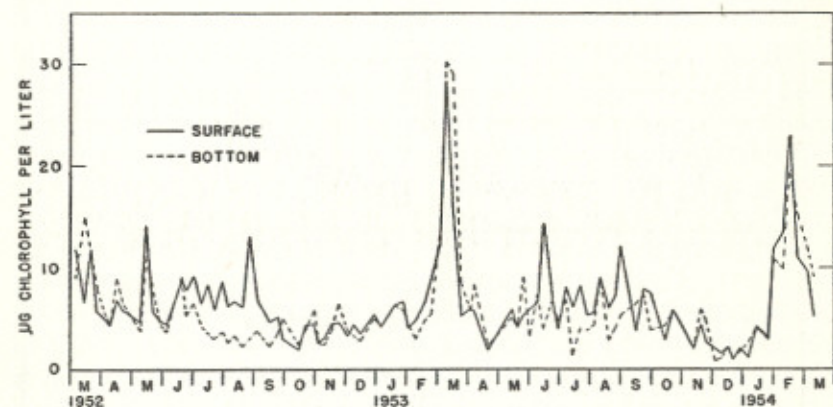

FIGURE 3. Distribution of chlorophyll in surface and bottom waters; average values for all stations.

greater concentrations in surface than in bottom waters. More chlorophyll was found in bottom waters just after the termination of periods of active growth and throughout the fall months. The horizontal movement of water masses could also account for some of the vertical variations in quantity. However, all such variations were small compared with the differences commonly observed in deeper and more stable waters.

Horizontal Distribution. At times there was a pronounced difference in concentration of surface phytoplankton between inshore and offshore stations (Fig. 4). In general, both cell numbers and chlorophyll concentrations per unit volume tended to be larger in the inshore waters. However, the total amount of phytoplankton underlying a unit area of sea surface was frequently greater offshore, as indicated in Table II. Chlorophyll estimates in Table II represent the average

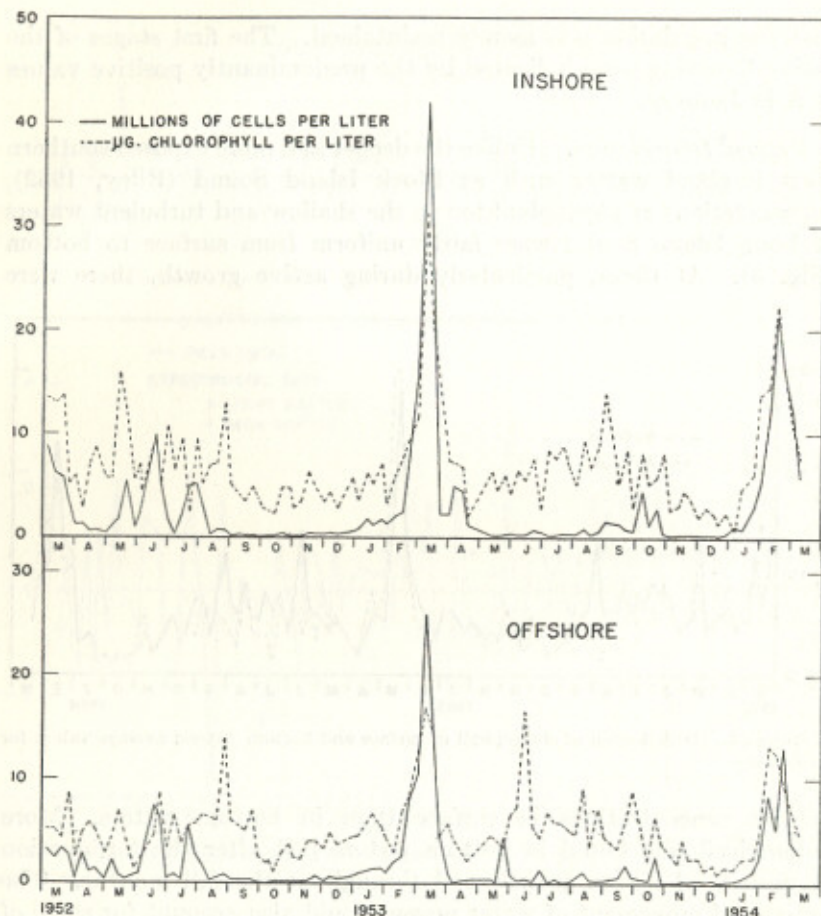

FIGURE 4. Cell number and chlorophyll distribution at inshore and offshore stations.

concentration at the several depths sampled multiplied by the depth of the water column. The estimate of cell numbers is a relatively crude one, since all of the counts were of surface samples, excepting St. 2. The latter is used in Table II to represent offshore conditions; the inshore estimate is based on the average surface concentration for all inshore stations multiplied by the average inshore station depth.

The concentration of phytoplankton in the Sound was considerably greater than that in other New England waters, and the quantity

TABLE II. COMPARISON OF CHLOROPHYLL AND CELL NUMBERS UNDER 0.1 M² OF SEA SURFACE FROM INSHORE AND OFFSHORE POSITIONS IN LONG ISLAND SOUND

Date	—µg chlorophyll—		—Cell numbers × 10 ⁶ —	
	Inshore	Offshore	Inshore	Offshore
May 14, 1952	1367	1381	181.6	149.6
July 22	713	591	497.5	641.0
Oct. 21	424	1036	36.4	24.8
Dec. 29	563	772	54.5	136.2
March 9, 1953	3342	3511	4166.3	5184.0
June 8	742	1154	31.5	68.4
Aug. 18	397	666	26.0	59.6
Oct. 21	661	979	273.6	502.6
Feb. 17, 1954	1925	2870	2133.8	1023.8

per unit area probably averaged slightly more. However, the highest spring flowering figures in the Gulf of Maine (Bigelow, *et al.*, 1940) were larger than those for Long Island Sound. In the waters around the Eddystone, Atkins and Jenkins (1953) obtained figures considerably larger than those for Long Island Sound; chlorophyll concentrations per cubic meter were comparable to those of Long Island Sound, but the column of water was four times deeper than that at the average offshore station in the Sound.

Although the size of the phytoplankton population per unit volume of water at inshore and offshore stations was often different, the sequence and occurrence of specific events corresponded closely in the two areas (Fig. 4). There are two possible explanations for this uniformity. Either the environmental character of the inshore and offshore waters was not significantly different, or else there was sufficient horizontal mixing to prevent differences in time of occurrence of specific events such as were found between coastal and offshore waters in the Gulf of Maine and in the North Sea. The spring flowering peak of 1954 was a minor exception; it occurred offshore one week later than inshore. However, this difference might simply have resulted from a sampling error.

Phytoplankton Composition. A breakdown of the population into groups, *i.e.*, centrate diatoms, pennate diatoms, dinoflagellates, and silicoflagellates, gives information which is masked in the consideration of the population as a whole and is lost in the detail of species analysis (Fig. 5). The spring flowering was made up chiefly of centrate diatoms. Although pennate diatoms and silicoflagellates showed distinct increases at this time, their numbers were insignificant in comparison with the centrate diatoms. Centrate diatoms con-

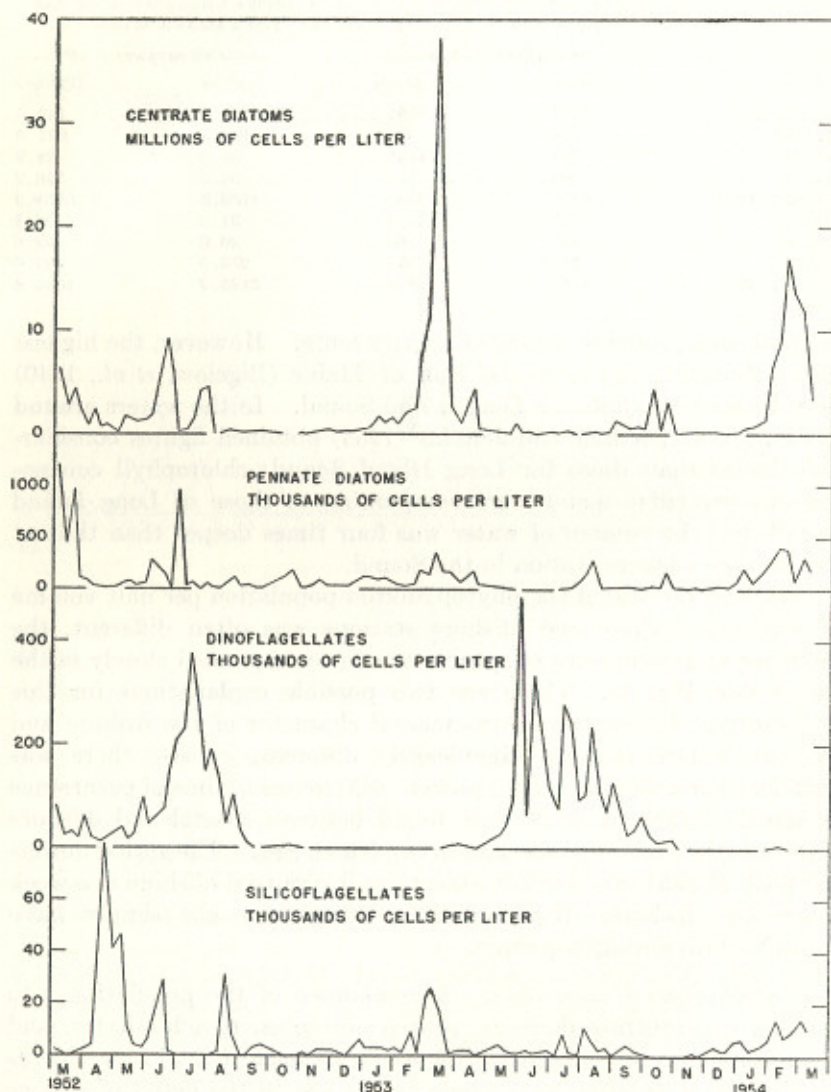

FIGURE 5. Distribution of the major taxonomic groups, averaged for all stations.

continued to be dominant through the spring months. In the summer, dinoflagellates comprised the most abundant segment of the population; the possible importance of small flagellates at this time has been mentioned previously. The difference between the spring and summer periods of 1952 and 1953 is re-emphasized by these data. In the spring and early summer, centrate diatoms were much more abundant in 1952 than in 1953, and the peaks of phytoplankton numbers typical of this period in 1952 were due to diatoms (Fig. 1). Conversely, in 1953 the population of dinoflagellates in late spring and summer was much greater than that of the same period in the previous year. In late summer, centrate diatoms became dominant again, and the fall flowering of 1953 was made up largely of this group. The small late fall and early winter populations were composed of centrate diatoms, pennate diatoms, and silicoflagellates, the centrate diatoms being the most abundant. The latter continued to dominate the population as it entered the spring flowering phase. As the flowering progressed, the large proportion of centrate forms relative to the other groups became even more exaggerated. When the annual crop of phytoplankton is considered, the greatest proportion, either numerically or with respect to weight of organic matter produced, was contributed by the centrate diatoms. Only in summer did another group, the dinoflagellates, assume a dominant position in the phytoplankton community.

The seasonal distribution of the major constituents of phytoplankton in the Sound is similar to that reported for Norwegian coastal waters by Braarud, *et al.* (1953). During winter, when the light intensity was low, they found that the surface waters became enriched through turbulence. As the light increased in spring, a diatom succession characteristic of the locality took place. After the diatom bloom had lowered nutrient supplies, the dinoflagellates became dominant. According to Grøntved (1952), the same group succession was found in the southern North Sea if nutrient renewal was sufficient and if grazing was not too severe. He believed that the late spring change from diatom to dinoflagellate dominance resulted from the establishment of thermal stability which prevented nutrient renewal through turbulent mixing; the nutrients were not completely depleted in the euphotic zone before the change took place. It was suggested that reduced competition between major phytoplankton groups, selective grazing by zooplankton, and "ecological conditions" aided

the cause of the dinoflagellates. Interestingly enough, the replacement of diatoms by dinoflagellates was later in 1947, the cooler year, than in 1948.

EXPERIMENTAL STUDIES

Experiments were designed to measure the effect of variations in light, temperature, and nutrients on the natural phytoplankton populations at various times during the year. Measurements were made of the amount of oxygen produced in photosynthesis and consumed in respiration. Changes in size and composition of the population were determined in all experiments, and in some, changes in chlorophyll and nutrient concentrations were also measured. These experiments were done with raw sea water, so that bacteria and small zooplankton as well as phytoplankton were included in the experimental bottles.

Methods. Sea water for the experiments was usually taken at one of the regular stations. If the experiment was a small one, the bottles were filled directly from the Nansen bottle. For larger experiments a carboy was filled, thoroughly agitated, and experimental aliquots were drawn off into the appropriate bottles. In experimental work that involved oxygen determinations, a glass bottle of suitable volume which contained a few glass beads for mixing purposes was completely filled with water, tightly stoppered, and thoroughly mixed twice; the oxygen bottles were then filled from this in the usual manner.

The light and dark bottle technique was employed to measure oxygen production and consumption, using 125 ml reagent bottles. Some of the bottles were exposed to natural illumination while others were placed in black cloth bags. At the end of an experiment, Winkler reagents were added to the bottles, care being taken to retain any bubbles of gas. Aliquots for cell counts and other analyses were taken from other bottles which had been treated in the same manner as the oxygen bottles. Furthermore, in the 1954 experiments, some of the bottles were covered with different thicknesses of cheesecloth so as to alter the amount of illumination received by the enclosed phytoplankton. The amount of light transmitted by the different amounts of cheesecloth was estimated in the Klett-Summerson Colorimeter; a glass microscope slide was wrapped in the required number of thicknesses of cloth and immersed in water in the measuring cell. Several different colored filters were employed, but the wave length had

little effect on the percentage of light transmitted. The average values are summarized in Table III.

TABLE III. RADIATION TRANSMITTED AND DEPTH EQUIVALENTS IN METERS FOR GAUZE-ENCLOSED EXPERIMENTAL BOTTLES

No. layers of gauze on bottle	% light penetration	Depth equivalent when Secchi disc equals:		
		1 m	2 m	3 m
2	24	0.8	1.6	2.5
4	8	1.5	2.9	4.4
6	3	2.1	4.1	6.1
8	1	2.7	5.4	8.1

Five experiments during the spring flowering of 1954 measured the effect of increased temperature on phytoplankton. Bottles were kept in tanks at the Milford Laboratory near a north window at a higher temperature than the rest of the experiment. Light conditions in these warmer bottles were probably not exactly the same as those in the bottles suspended in Milford Harbor, but they were close enough so that differences in results in the two sets of bottles must be attributed to temperature and not to light.

The effects of nutrients were also tested, singly and in various combinations. *P* and *N* were employed in all experiments, and in some experiments iron, manganese, citric acid, soil extract, and dextrose were used as well. Nitrogen was added as NaNO_3 , phosphorous as KH_2PO_4 , manganese as MnCl_2 , and iron as ferric citrate with citric acid as a chelator (Rodhe, 1948). *P* and *N* were never added in quantities greater than the maximum quantities found in the Sound. The other inorganics were added in similar small amounts. Additions of soil extract were 1% or less of the volume of the experimental water.

Usually the experimental bottles, placed in wire cages, were suspended to a depth of 0.5 m in Milford Harbor, Connecticut. The cage was hung from a boat mooring line to eliminate changes in depth with tidal fluctuations. In this manner natural conditions of light and temperature were duplicated as closely as possible. A few oxygen experiments were done at anchor stations in the summer of 1953. Here water was taken from a series of depths, and the experimental bottles were resuspended at those depths for the duration of the experiment. Three experiments in February 1954 were kept in the dock house at the Milford Laboratory because the Harbor was iced over; light conditions in these experiments were unnatural, since

the bottles were immersed in tanks in a building with only small windows.

Oxygen Experiments. Fig. 6A summarizes the results of the oxygen experiments. Moderate to high production of oxygen and low

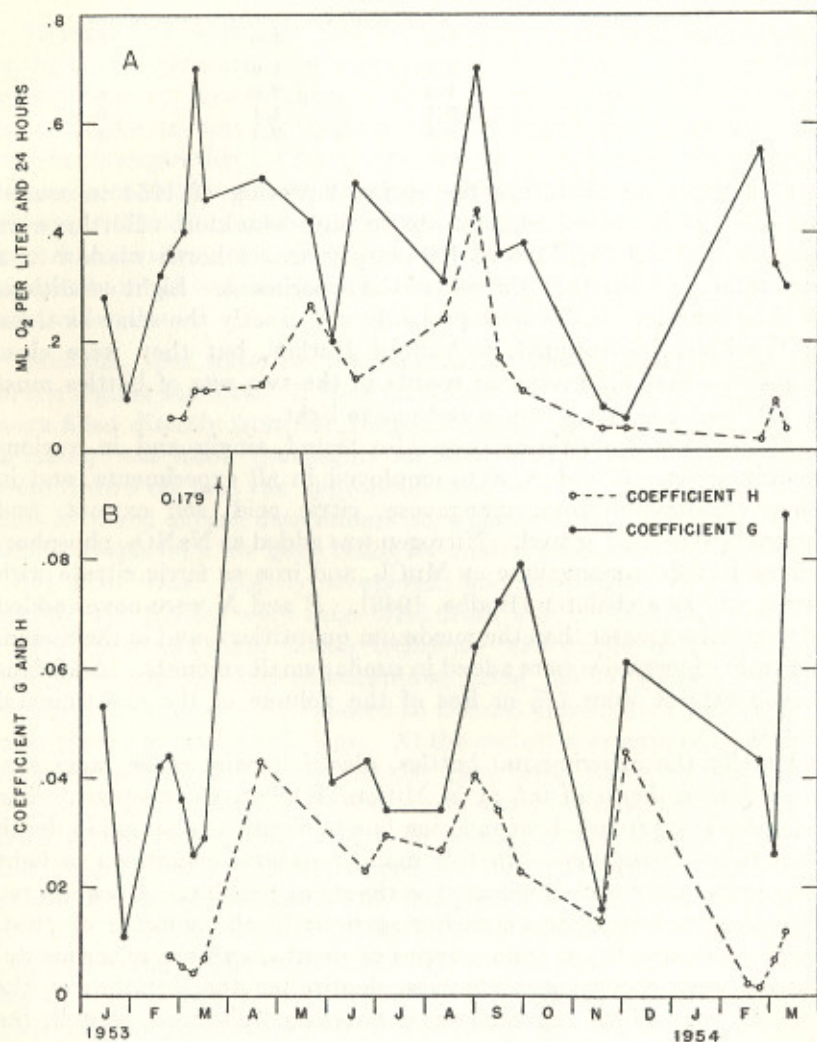

FIGURE 6. A. Oxygen production (solid circles) and consumption (open circles). B. Coefficients of oxygen production (Coeff. G) and consumption (Coeff. H).

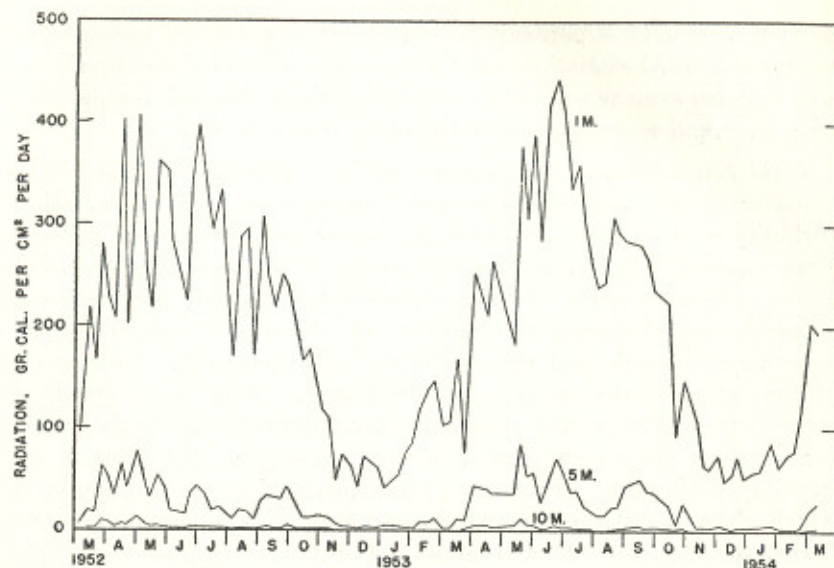

FIGURE 7. Estimated light reaching several depths in Long Island Sound over a two year period.

respiration were associated with the spring flowering and the spring period generally. In summer, oxygen production was less and oxygen consumption was markedly higher than in the earlier months. Moderate to high oxygen production was characteristic of the fall months, while consumption decreased progressively from the summer maximum. Winter was a time of minimum oxygen production and consumption.

To make results of the oxygen experiments comparable, coefficients of photosynthesis and respiration were calculated as the amount of oxygen produced or consumed in ml per 24 hours per μg of chlorophyll. These data are plotted in Fig. 6B. When Figs. 6A and 6B are compared, it is obvious that the amount of oxygen produced or consumed was not simply a function of the amount of chlorophyll present. For instance, during the spring flowering in 1953, production coefficients in late February for the early stages of the flowering were higher than those observed during the climax a few weeks later.

The photosynthetic and respiratory coefficients were compared with growth coefficients in natural and experimental populations, initial nutrient concentrations, light, and temperature. This com-

parison was only superficial, since the data were not adequate to warrant detailed statistical treatment. The only obvious correlation was that between temperature and respiration, although temperature may have had some influence on photosynthesis as well.

Light Experiments. The amount of light available to the phytoplankton in the natural environment varies with incident radiation, turbidity of the water, and the depth of the cell in the water column. Experimentally, light was varied by means of the gauze bags described above. Measurements of oxygen production showed that there was a relationship between the amount of radiation received by the experimental bottle and the photosynthetic coefficient. The results of four experiments are graphed in Fig. 8. While photosynthesis appears to depend on the amount of available light, all of the curves for the four experiments are different, suggesting that light is not the only factor that influences oxygen production. The population which showed greatest growth in enrichment and temperature experiments was also affected most strikingly by variations in light intensity (Fig. 8). The two higher curves were obtained with populations taken at the peak of the spring flowering and several weeks after the climax. The population that was present immediately after the climax of the flowering had a much lower level of response to light, suggesting a possible depression in the physiological state of the cells at that time.

Although maximum cell numbers and maximum chlorophyll values did not necessarily occur in the same bottle, the highest values for chlorophyll and cell production were found consistently in bottles receiving less than the maximum available light, and they were also found occasionally in bottles receiving the minimum amount (see Table IV). In an early summer experiment in 1954, the greatest increase in cell numbers occurred in an unenriched bottle covered with two layers of gauze. This increase was due to growth of several diatoms, namely *Leptocylindricus danicus*, *Skeletonema costatum*, and *Thalassionema nitzschioides*. In this experiment higher chlorophyll values were obtained in some of the enriched bottles, but this increase appeared to result primarily from the growth of small flagellates.

Some of the most important results of the light experiments were found in the response of different species to varying amounts of radiation. Experiments during the early spring flowering of 1954 showed that *Skeletonema costatum* had the highest growth rate coef-

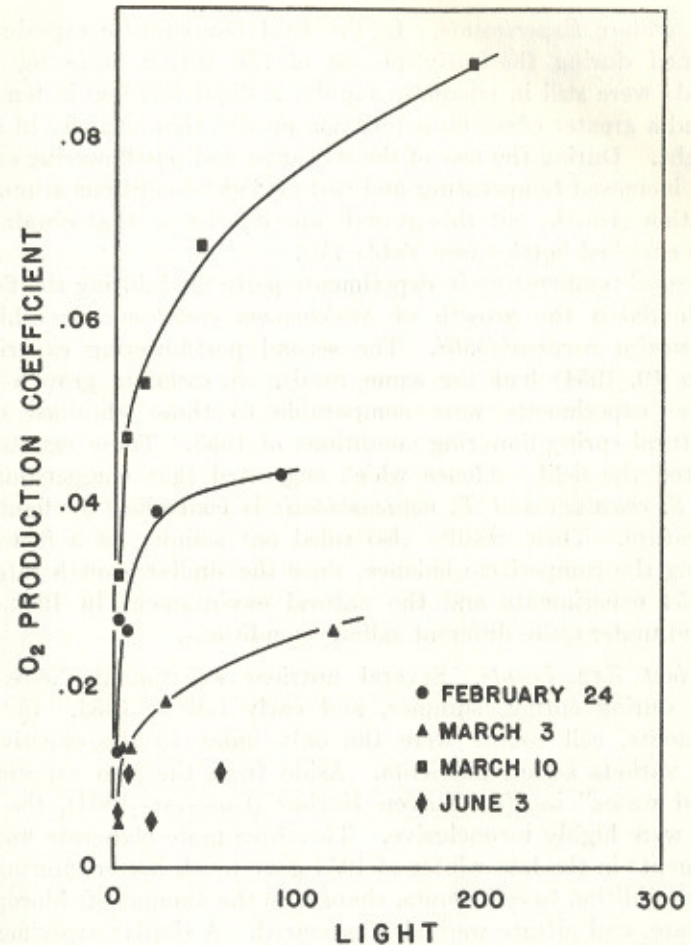

FIGURE 8. Oxygen production coefficients in four experiments as related to light intensity (g cal/cm² in a day).

ficient K in bottles receiving greater amounts of light. In bottles receiving smaller amounts of radiation, *Thalassiosira nordenskiöldii* had the highest K values, and those were almost all greater than any of the *S. costatum* K values.

K values in dark bottles usually had the same sign (*i.e.*, positive or negative) as the K values in the corresponding light bottles, but they were smaller. The K values obtained in the bottles and in the Sound for the same population often were quite different (Fig. 2).

Temperature Experiments. In the 1954 temperature experiments, performed during the early phases of the spring flowering when nutrients were still in adequate supply, a slight increase in temperature had a greater effect on population growth than changes in available light. During the rest of the flowering and postflowering experiments, increased temperature and certain light conditions stimulated population growth, but this growth was inferior to that obtained in certain enriched bottles (see Table IV).

Increased temperature in experiments performed during the flowering stimulated the growth of *Skeletonema costatum* but inhibited *Thalassiosira nordenskiöldii*. The second postflowering experiment (March 10, 1954) had the same result. *S. costatum* growth rates in these experiments were comparable to those obtained under the natural spring flowering conditions of 1953. These results corroborated the field evidence which suggested that competition between *S. costatum* and *T. nordenskiöldii* is controlled by light and temperature. These results also ruled out salinity as a factor influencing the competitive balance, since the similar growth rates for the 1954 experiments and the natural environment in 1953 were obtained under quite different salinity conditions.

Nutrient Experiments. Several nutrient experiments were conducted during spring, summer, and early fall in 1953. In these experiments, cell counts were the only index to the effectiveness of the various added nutrients. Aside from the two experiments on "red water" in New Haven Harbor (Conover, 1954), the 1953 results were highly inconclusive. The three more elaborate nutrient experiments in the late winter of 1954 gave much better information, since, in addition to cell counts, changes in the amount of chlorophyll, phosphate, and nitrate were also measured. A similar experiment in the summer of 1954 showed conclusively that cell counts were not an adequate measure of change in the enriched experimental bottles. Great increases in chlorophyll and utilization of nutrient supplies were not reflected in a corresponding change in cell numbers, so it may be assumed that many of the actively growing organisms did not withstand formalin. These results suggest that the 1953 experiments were inadequate for the purpose, in that insufficient measurements were made of the various aspects of population growth. However, they provided a small amount of useful information that will be included under the discussion of individual species.

TABLE IV. SUMMARY OF DATA FOR SIX EXPERIMENTS IN THE WINTER AND SPRING OF 1954. WHEN NUTRIENTS WERE USED, THEY WERE ADDED IN THE FOLLOWING AMOUNTS PER LITER: 20 μ -at NO₃-N, 2 μ -at PO₄-P, 1 μ -at Mn, and 0.2 μ -at Fe. A WEIGHT OF CITRIC ACID (CA) EQUAL TO THE WEIGHT OF FERRIC CITRATE WAS USED PER LITER. IA = INITIAL ANALYSIS; LB = LIGHT BOTTLE; DB = DARK BOTTLE; 2 G = 2 LAYERS GAUZE, ETC. ALL EXPERIMENTS EXCEPT THE FIRST TWO HAD APPROXIMATELY NORMAL LIGHT EXPOSURE, LISTED AS g cal/cm²/day.

Date	No. days	Oxygen experiments			Other experiments					Thous. of cells/l	
		Est. rad.	Av. temp.	O ₂ ml/l	Est. rad.	Av. temp.	P μ -at/l	N μ -at/l	Chlor. μ g/l		
February 10.	Experiment kept in unnatural light conditions in dock house.										
IA	—	—	—	8.27	—	—	1.23	1.4	15.5	14,085	
LB	2	—	1.7	9.06	—	—	1.53	1.1	26.8	17,160	
LB & 2G	2	—	1.7	8.76	—	—	1.64	1.1	30.7	14,550	
LB & 4G	2	—	1.7	8.71	—	—	1.67	1.1	22.6	16,200	
LB & 6G	2	—	1.7	8.65	—	—	1.66	1.2	28.2	14,070	
LB & 8G	2	—	1.7	8.61	—	—	1.58	1.2	21.9	19,040	
DB	2	—	1.7	8.48	—	—	1.67	1.1	23.7	14,230	
With increased temperature:											
LB	—	—	—	—	—	—	1.51	0.0	33.4	17,050	
LB	—	—	—	—	—	—	1.51	0.0	33.4	19,150	
LB	—	—	—	—	—	—	0.95	0.0	25.7	18,203	
LB	—	—	—	—	—	—	0.78	0.0	39.4	29,020	
February 17.	Experiment kept in unnatural light conditions in dock house.										
IA	—	—	—	8.50	—	—	1.19	0.03	23.1	32,390	
LB	2	—	2.4	8.75	—	—	1.12	0.03	24.2	16,390	
LB & 2G	2	—	2.4	8.65	—	—	1.11	0.03	32.5	23,530	
LB & 4G	2	—	2.4	8.54	—	—	1.18	0.05	23.7	26,031	
LB & 6G	2	—	2.4	8.50	—	—	1.17	0.7	24.6	20,530	
LB & 8G	2	—	2.4	8.42	—	—	1.21	0.05	16.4	19,920	
DB	2	—	2.4	8.41	—	—	1.21	1.5	22.8	21,700	
With increased temperature:											
LB	—	—	—	—	—	—	1.04	0.0	27.7	26,030	
LB	—	—	—	—	—	—	1.01	0.0	21.1	19,320	
LB	—	—	—	—	—	—	0.89	0.2	24.7	24,400	
LB	—	—	—	—	—	—	1.24	0.0	30.6	28,750	

TABLE IV.—Continued

	Oxygen experiments				Other experiments							
	No. days	Est. rad.	Av. temp.	O ₂ ml/l	No. days	Est. rad.	Av. temp.	P μg-at/l	N μg-at/l	Chlor. μg/l	Thous. of cells/l	
February 24.												
IA	—	—	—	8.48	—	—	—	1.06	0.1	12.8	12,340	
LB	2	91	3.7	9.54	5	107	3.8	0.83	0.1	13.0	18,570	
LB & 2G	2	22	3.7	9.44	5	26	3.8	0.89	0.1	16.6	25,200	
LB & 4G	2	7	3.7	9.09	5	9	3.8	0.95	0.06	12.5	20,200	
LB & 6G	2	3	3.7	9.14	5	3	3.8	0.89	0.00	17.0	23,560	
LB & 8G	2	0.8	3.7	8.76	5	1	3.8	0.82	0.05	11.4	22,850	
DB	2	—	3.7	8.44	5	—	3.8	1.06	0.1	13.3	19,260	
LB with nutrients added:												
P	—	—	—	—	5	107	3.8	2.88	0.05	17.2	16,360	
N	—	—	—	—	5	107	3.8	0.56	12.6	24.4	25,370	
Mn	—	—	—	—	5	107	3.8	0.86	0.03	12.8	18,360	
Fe	—	—	—	—	5	107	3.8	0.86	0.00	15.0	16,840	
Ca	—	—	—	—	5	107	3.8	0.84	0.06	13.3	15,850	
P,N	—	—	—	—	5	107	3.8	2.32	12.5	29.7	22,350	
P,N,Mn	—	—	—	—	5	107	3.8	2.38	11.5	23.5	21,080	
P,N,Fe	—	—	—	—	5	107	3.8	2.29	9.3	29.6	20,920	
P,N,CA	—	—	—	—	5	107	3.8	2.30	10.6	28.2	21,690	
P,N,Mn,Fe	—	—	—	—	5	107	3.8	2.34	9.9	31.7	16,340	
P,N,Mn,CA	—	—	—	—	5	107	3.8	2.30	8.9	29.3	23,470	
With increased temperature:												
LB	—	—	—	—	5	5	7.0	0.77	0.2	19.3	31,690	
LB	—	—	—	—	7	5	7.0	0.62	0.06	17.2	22,960	
March 3.												
IA	—	—	—	8.09	—	—	—	0.76	0.06	13.2	21,730	
LB	2	119	3.7	8.59	5	163	2.7	0.68	0.05	16.6	19,870	
LB & 2G	2	28	3.7	8.39	5	39	2.7	0.73	0.03	21.6	21,300	
LB & 4G	2	9	3.7	8.26	5	13	2.7	0.79	0.04	16.6	25,270	
LB & 6G	2	5	3.7	8.26	5	5	2.7	0.80	0.00	22.5	25,200	
LB & 8G	2	2	3.7	8.06	5	2	2.7	0.75	0.05	16.6	19,440	
DB	2	—	3.7	7.92	5	—	2.7	0.84	0.03	17.9	21,480	

TABLE IV.—Continued

	Oxygen experiments				Other experiments							
	No. days	Est. rad.	Av. temp.	O ₂ ml/l	No. days	Est. rad.	Av. temp.	P μg-at/l	N μg-at/l	Chlor. μg/l	Thous. of cells/l	
LB with nutrients added:												
P	—	—	—	—	5	163	2.7	2.61	0.03	21.9	18,650	
N	—	—	—	—	5	163	2.7	0.57	21.7	17.9	16,940	
Mn	—	—	—	—	5	163	2.7	0.73	0.01	21.1	14,120	
Fe	—	—	—	—	5	163	2.7	0.74	0.12	14.9	16,435	
CA	—	—	—	—	5	163	2.7	0.71	0.06	17.5	14,570	
P,N	—	—	—	—	5	163	2.7	2.33	21.5	23.8	20,320	
P,N,Mn	—	—	—	—	5	163	2.7	2.44	15.4	17.6	16,450	
P,N,Fe	—	—	—	—	5	163	2.7	2.39	16.6	23.7	17,430	
P,N,CA	—	—	—	—	5	163	2.7	2.40	13.2	19.9	19,270	
P,N,Mn,Fe	—	—	—	—	5	163	2.7	2.44	14.1	24.0	21,240	
P,N,Mn,CA	—	—	—	—	5	163	2.7	2.53	14.1	24.8	20,430	
With increased temperature:												
LB	—	—	—	—	5	8	7.0	0.61	0.12	19.3	16,560	
March 10.												
IA	—	—	—	7.82	—	—	—	1.16	0.04	3.4	2,658	
LB	2	196	3.7	8.33	7	134	3.4	0.73	0.09	8.5	9,600	
LB & 2G	2	47	3.7	8.20	7	32	3.4	0.91	0.12	11.8	9,600	
LB & 4G	2	16	3.7	8.10	7	11	3.4	0.84	0.05	8.7	7,998	
LB & 6G	2	6	3.7	8.05	7	4	3.4	0.87	0.11	10.9	7,860	
LB & 8G	2	2	3.7	7.95	7	1	3.4	0.96	0.03	5.9	8,430	
DB	2	—	3.7	7.74	7	—	3.4	1.03	0.18	6.5	3,708	
LB with nutrients added:												
P	—	—	—	—	7	134	3.4	2.50	0.11	9.7	12,340	
N	—	—	—	—	7	134	3.4	0.56	13.8	19.9	16,170	
Mn	—	—	—	—	7	134	3.4	0.84	0.05	11.6	8,145	
Fe	—	—	—	—	7	134	3.4	0.83	0.05	8.6	10,710	
CA	—	—	—	—	7	134	3.4	0.86	0.07	9.1	11,220	
P,N	—	—	—	—	7	134	3.4	2.27	12.5	23.0	13,680	
P,N,Mn	—	—	—	—	7	134	3.4	2.23	7.7	20.0	13,400	
P,N,Fe	—	—	—	—	7	134	3.4	2.18	7.3	22.5	14,500	
P,N,CA	—	—	—	—	7	134	3.4	2.28	7.3	17.8	12,720	
P,N,Mn,Fe	—	—	—	—	7	134	3.4	2.37	8.4	25.4	14,940	
P,N,Mn,CA	—	—	—	—	7	134	3.4	2.37	8.2	19.2	16,920	

TABLE IV.—Continued

Origin experiments				Other experiments						
No. days	Est. rad.	Ae. temp.	O ₂ ml/l	No. days	Est. rad.	Ae. temp.	P μg-at/l	N μg-at/l	Chlor. μg/l	Thous. of cells/l
With increased temperature:										
LB	—	—	—	7	6	7.0	0.91	0.07	10.4	11,690
June 3.										
LA	—	—	6.12	—	—	—	—	—	—	—
LB	2	17.6	—	8	202	16.7	0.52	0.07	1.9	850
LB & 2G	2	17.6	6.00	8	48	16.7	0.41	0.07	1.6	365
LB & 4G	2	17.6	5.84	8	16	16.7	0.31	0.27	2.8	3,293
LB & 6G	2	17.6	6.00	8	6	16.7	0.50	0.81	1.2	868
LB & 8G	2	17.6	5.87	8	2	16.7	0.40	0.27	1.5	996
DB	2	17.6	5.71	8	—	16.7	0.40	—	1.4	1,227
DB	2	17.6	—	8	—	16.7	0.57	0.10	0.4	232
LB with nutrients added:										
P	—	—	—	8	202	16.7	1.63	0.14	2.2	1,521
N	—	—	—	8	202	16.7	0.00	10.9	10.5	1,385
Mn	—	—	—	8	202	16.7	0.17	0.10	3.7	918
Fe	—	—	—	8	202	16.7	0.28	0.24	2.8	1,243
CA	—	—	—	8	202	16.7	0.24	0.10	4.7	1,534
P,N	—	—	—	8	202	16.7	0.68	0.68	13.3	1,809
P,N,Mn	—	—	—	8	202	16.7	0.70	0.14	16.6	2,089
P,N,Fe	—	—	—	8	202	16.7	0.68	0.20	10.6	1,123
P,N,CA	—	—	—	8	202	16.7	0.76	0.03	13.7	1,016
P,N,Mn,Fe	—	—	—	8	202	16.7	0.67	0.10	18.3	1,718
P,N,Mn,CA	—	—	—	8	202	16.7	1.48	0.10	9.9	2,419

In the spring flowering experiments, addition of nitrate had the greatest effect of all nutrients on population growth. In two of three experiments it restored the population to the natural flowering level, suggesting that depletion of this nutrient was the chief cause of the termination of the flowering. Addition of phosphorous and iron brought about small population increases, and when either or both were added along with nitrogen, slightly greater population increases took place than when nitrogen was added alone. Citric acid showed a smaller stimulatory effect. Manganese alone had no stimulatory effect; in fact, the results might be interpreted as a slight inhibition. When added with other nutrients, however, manganese appeared to have some favorable effect (see Table IV).

The experiments also emphasized the importance of the physiological state of the organisms. Laboratory culture experiments have suggested that the postflowering population is in a physiological state of senescence. A lag period during which there is a shift from a maintenance metabolism to active growth is demonstrated by such populations when they are placed under conditions favorable to active growth. The postflowering experiments on March 3, 1954 showed that this was taking place in a natural population. This was the only experiment in which spring flowering levels were not restored, even though the length of time, light, and temperature were comparable to other experiments.

The summer experiments of 1954 gave results similar to the spring flowering experiments. Highest chlorophyll levels attained in the enriched bottles were almost as high as the spring flowering ones. Nitrogen was again the nutrient that brought about the greatest increases. The other four nutrients had some stimulatory effect, phosphorous and manganese being somewhat more effective than iron and citric acid. The nutrient effects were almost additive in this experiment (see Table IV).

SPECIES ACCOUNTS

In order to separate the more important species of phytoplankton in Long Island Sound from the less important ones, two rather arbitrary categories were set up. The major constituents were defined as species which occurred in numbers greater than 5% of the total phytoplankton at least once in the two years of study. The minor constituents were always found in numbers less than 5% of the total

population. Since the total population size varied from week to week, the 5% demarkation represents no real number.

Some 40 species may be classified as major constituents. Some species were present during most of the year while others were restricted to a particular season. Nearly 150 species were found as minor constituents. The minor constituents can be further subdivided into two groups: those which were found often or in sufficient numbers to indicate that they were growing in the Sound; and those which were found only occasionally in small numbers and which were probably immigrants unable to establish themselves in the Sound. Only the first group of minor constituents will be considered in this paper.

In addition to notes on the occurrence and abundance of the various species, other pertinent information obtained from the environmental and experimental data is included. Any significant difference in distribution between inshore and offshore waters is also recorded. If a species is found chiefly inshore it may have requirements for land-derived nutrients, lower salinity, or some favorable light or nutrient condition associated with the shallow water column. More frequent occurrence of a species offshore might suggest requirements for higher salinity or some other condition associated with the deeper water column. The highest concentration, unless otherwise noted, represents the highest count obtained in a single sample.

Certain species in the following list are marked with an asterisk (*) to call attention to the fact that, although the cell numbers are low, the cells are large and undoubtedly made a greater contribution to the economy of the Sound than their numbers would suggest.

MAJOR SPECIES

Centrate Diatoms

Cerataulina pelagica.² A bloom of this species in May 1952 when the water temperature was around 10° C lasted several weeks. Another shorter but larger bloom occurred in late summer 1953 when the water temperature was 23°. Cell concentrations in a single sample reached nearly 2 million. Traces were found throughout most of the rest of the two year period. Field and experimental

² Hendey's (1954) checklist of British marine diatoms was used throughout as the model for names and spellings.

data suggest that it grows well in moderate light conditions if the water contains some inorganic nutrients.

Chaetoceros affine was found in August and September of both years. A few cells were also recorded in winter. It was not found in salinities lower than 27‰, and it was observed offshore more often than inshore. Highest concentration 90,000 cells/l.

Chaetoceros compressum, found the year round, was most common in August 1952, from the spring flowering through May in 1953, and in the spring flowering of 1954. Experiments suggest that it prefers lower light intensities and is not found when nutrients are low. Highest concentration 259,000 cells/l.

Chaetoceros curvisetus was found from July through October, with a peak in September. It was a major constituent of the population at this time of the year. Traces in November 1952 and March 1954 were the only other occurrences. Maximum temperatures and moderately high radiation values characterized its period of abundance. Highest concentration 368,000 cells/l.

Chaetoceros debile, occurring occasionally and in small numbers from the end of the spring flowering through October, was more common inshore. Greatest concentration 87,000 cells/l.

Chaetoceros didymum, taken in small numbers sporadically from the end of the spring flowering through fall, was more common offshore. Seasonal distribution and results of one experiment suggest that this species has a high light requirement.

Chaetoceros radians-*Chaetoceros tortissimum*. These two species are combined since there was some confusion in identification. Large numbers were found from January until several weeks after the spring flowering, with smaller numbers in late spring and early summer. These species were completely absent only in fall and early winter. Highest concentration, during the spring flowering, 2,348,000 cells/l.

Corethron criophilum was found from August through December in both years, with a trace in March 1952. The populations were larger in 1953 than in 1952. Salinities were always above 27‰ at these times, and it was taken offshore more often. Marked increases were recorded in light bottle experiments. Radiation means for the period of occurrence were higher in 1953 than in 1952. Highest number 36,000 cells/l.

**Coscinodiscus perforatus cellulosa* was taken regularly from July through January, with maximum abundance around mid-September.

An occasional cell was found in the spring plankton. Found offshore slightly more often. Highest concentration 21,000 cells/l.

Coscinodiscus radiatus was taken the year round in small numbers, but the greatest concentrations were found in August of both years, with slightly smaller numbers in May and June 1952. Maximum concentration 24,000 cells/l.

**Eucampia zoodiacus* was found only in 1952. Common in the spring diatom population, it reached a peak concentration in May. It occurred again in August and then disappeared.

Guinardia flaccida, found from April through July, was most abundant in May 1952. Only a trace of it was found during the corresponding period in 1953. Greatest number 156,000 cells/l.

Lauderia borealis was a late winter and spring flowering form. The peak came in mid-March, following or coinciding with the spring flowering. In 1952, when phytoplankton was generally more abundant, the species was observed through April, while in 1953 it disappeared four weeks earlier. Temperatures under 10°, with an optimum from 3-7°, are suggested for this species by the field data.

Leptocylindricus danicus. Included here are two forms which, had intergrades not been found, could have been called *Leptocylindricus danicus* and *L. minimus*. The two year cycle is shown in Fig. 9. The highest concentration was found in June 1952, although it was common throughout the preceding spring months. Corresponding spring and early summer populations were insignificant in 1953. It was taken slightly more often inshore.

It increased under all conditions of light, temperature, and nutrient enrichment in experiments during the spring flowering period. In light experiments early in the season, the greatest increases occurred in bottles receiving the most light; with the seasonal progression in incident radiation, the greatest increases took place in the gauze-covered bottles. In the June 1954 experiment, this species did not increase significantly in any bottles that were exposed to the maximum available light, including enriched ones, but it did increase significantly in the bottle receiving about 25% of the maximum.

Paralia sulcata (Fig. 9). Throughout most of the annual cycle this species was found in small numbers, but in fall and winter it became a chief constituent and was an important species in any fall flowering that occurred. In experiments, it grew best in light of low intensity,

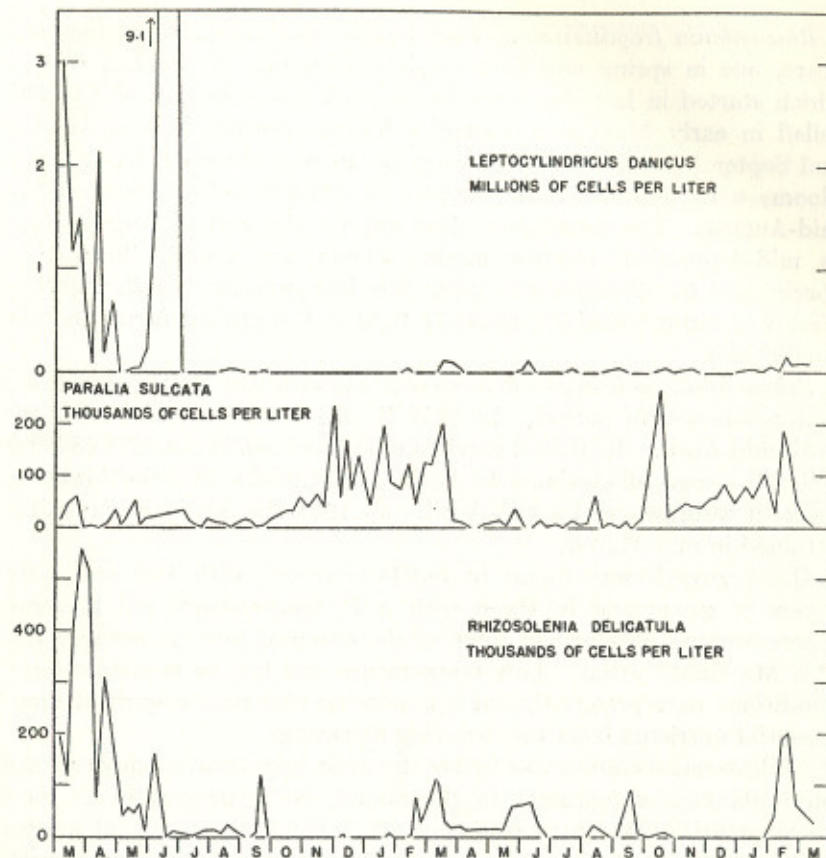

FIGURE 9. Distribution of *Leptocylindricus danicus*, *Paralia sulcata*, and *Rhizosolenia delicatula*.

with enrichment and with a temperature of at least 7°. The experimental evidence helps to explain its abundance in fall and winter.

Rhizosolenia delicatula (Fig. 9). Maximum numbers were found in spring 1952. Smaller numbers occurred in spring 1953 and in the fall of both years. As the incident radiation increased in the spring, this species was more successful in experimental bottles that received less than the maximum light available. It also did well in enriched bottles, *N* and *P* taking first and second place respectively as the most essential nutrients. In one experiment this species disappeared from light bottles, whether enriched or not.

Rhizosolenia fragillissima. Four blooms were recorded in the two years, one in spring and three in late summer. In 1952, a bloom which started in late April reached a peak concentration of 144,000 cells/l in early May, and a smaller bloom occurred in late August and September. In 1953 no spring bloom was observed, but a large bloom, with highest concentrations of 387,000 cells/l, occurred in mid-August. The population died out by the end of August, but in mid-September another smaller bloom was found. Both this species and *R. delicatula* were present in late summer, but *R. fragillissima* was more abundant; possibly light is the critical factor in this competition.

Schroederella delicatula was associated with the spring flowering and postflowering period. In 1952 it was found in small numbers until mid-April. In 1953 it reached a peak concentration of 1,558,000 cells/l (average, all stations) on April 1, three weeks after the flowering peak; it disappeared by mid-April. In 1954 the peak was probably attained in mid-March.

Good growth was found in bottles covered with two and four layers of gauze and in those with a 7° temperature, but greatest increases were obtained in some of the enriched bottles, notably the P,N,Mn combination. Low temperature and low to moderate light conditions were preferred, and it is possible also that it derived some essential nutrients from the decaying flowering.

Skeletonema costatum was by far the most important member of the phytoplankton community in the Sound, being present in at least trace quantities the year round (Fig. 10). It was the dominant species of the 1953 spring flowering, and in 1954 it shared dominance with *Thalassiosira nordenskiöldii*. During spring and summer, small blooms took place, these being much larger in 1952 than in 1953. A small bloom was also recorded in the fall flowering of 1953.

In most experiments during the spring flowering of 1954, this species had a greater growth rate in light bottles and in those covered with two layers of gauze than did *Thalassiosira nordenskiöldii*. It increased most rapidly at this time at temperatures slightly higher than the environmental temperature of 1954. In later experiments during the spring flowering, good growth occurred in uncovered bottles and in bottles kept at higher temperatures, but best growth took place in enriched bottles, N being the most critical nutrient. In other experiments during the warm months of 1953, *S. costatum*

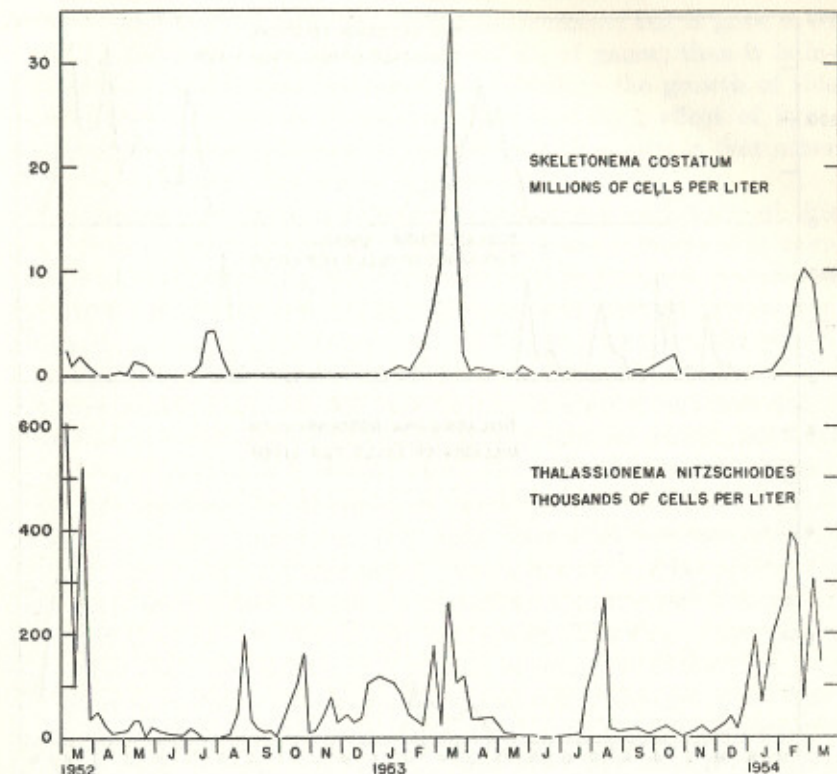

FIGURE 10. Distribution of *Skeletonema costatum* and *Thalassiosira nitzschioides*.

exhibited some growth in enriched bottles, but better growth was often obtained in control bottles. In the 1954 summer experiment, best growth took place in the bottle covered with two layers of gauze. Experimental data indicate that there were limits of light and temperature below which *S. costatum* was less successful than other species, but there was a wide range of conditions above these minima in which it was dominant over most of the others. The summer of 1953 imposed some limits on *S. costatum* which were not present in 1952. Braarud (1945) found this species more successful at 10° C than any other species in his experiments.

Thalassiosira decipiens. The three most important species of *Thalassiosira* followed each other in regular succession throughout the year (Fig. 11). *T. decipiens* was the fall and winter species.

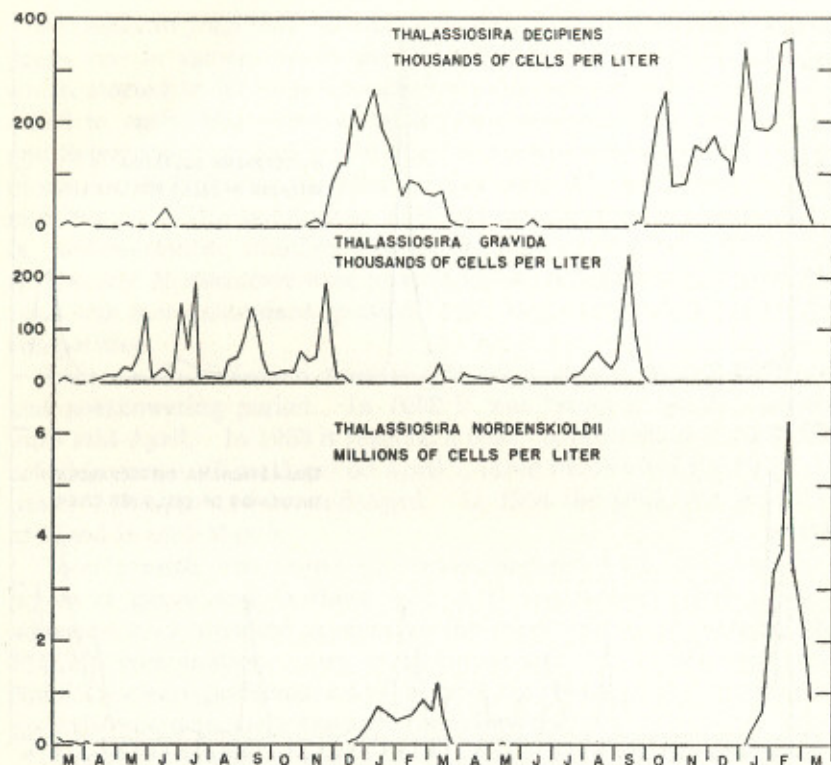

FIGURE 11. Distribution of *Thalassiosira nordenskiöldii*, *T. decipiens*, and *T. gravida*.

It appeared in late September or October and was taken continuously until the end of March. Small numbers were occasionally found in spring and early summer. It was a chief constituent of the 1953 fall flowering, and this species and *Paralia sulcata* were the two most abundant forms throughout late fall and winter. During the spring flowering in 1954, it was found to be most successful experimentally at temperatures higher than those of the Sound, in gauze covered bottles, and in enriched bottles. These results help in interpreting the fall and winter abundance of this species.

Thalassiosira gravida was the spring, summer, and early fall form of this genus. Fig. 11 shows that, like many other diatoms, it was more successful in 1952 than in 1953. In both years there was a bloom just before it was replaced by *T. decipiens*. In the 1954

summer experiment it did well with N enrichment, but it grew even better in the bottle covered with two layers of gauze; thus it is indicated that, while abundant nutrients stimulate the growth of this species, they only partially overcome the inhibiting effect of light. An alternative interpretation of the light bottle results is that other species successfully outcompete *T. gravida*.

Thalassiosira nordenskiöldii was the spring flowering form of this genus. It was merely present in 1952, had a small bloom that coincided with the 1953 spring flowering, and, with *S. costatum*, dominated the 1954 spring flowering (Fig. 11). As was pointed out above, spring flowering temperatures and light were lower in the earlier 1954 flowering than they were in 1953.

Experimental work showed that this species grew best and had a higher growth rate than *S. costatum* at low light intensities but that it was dominated by *S. costatum* when the temperature was increased. Good growth was also obtained in bottles enriched with N and P. Thus, low temperatures and low light intensities are suggested as optimal, assuming no deficiency in the nutrient supply. If proper light and temperature conditions prevail at a time when the rest of the conditions are favorable for the spring flowering, this species will either share dominance with or outcompete *S. costatum*.

Thalassiosira rotula occurred only sporadically throughout the year. Small blooms took place during and just following the spring flowering, in May-June, in mid-July, and in September and October. Small numbers occurred throughout the rest of the year. Maximum concentration 375,000 cells/l in autumn 1953. Found more often inshore.

Pennate Diatoms

Asterionella formosa, properly speaking, is a freshwater form. It is undoubtedly carried by rivers into the Sound, where it can perhaps exist marginally. It was found from January to May and was most abundant, as might be expected, after periods of high precipitation. Highest concentration 57,000 cells/l. Normally the numbers were much smaller.

Asterionella japonica was more successful in 1952 than in 1953. Highest numbers were found in March, and it was abundant from May through July 1952. It disappeared in August and was not found again until January 1953. One peak in 1953 coincided with

the spring flowering; smaller peaks were found in April and July. A moderate bloom was found in October 1953 at the beginning of the fall flowering. After this it disappeared and was not found again until March 1954. Found more often inshore. Largest numbers 1,454,000 cells/l.

In the March 1954 experiments this species grew best in some of the gauze-covered bottles. It was also successful in a bottle with a raised temperature as well as in bottles enriched with citric acid only and with a combination of N,P,Mn, and citric acid. All evidence indicates that this species can grow in a wide range of temperature conditions and that it prefers moderate light conditions provided nutrients are present in concentrations greater than the minimum in the Sound. The more frequent occurrence of this species inshore, coupled with its success in bottles enriched with citric acid, suggests a possible requirement for organic substances.

Nitzschia delicatissima. This species, found in the spring and late summer months of 1952, was taken only in May 1953. It was never really successful in Long Island Sound. Highest concentration only 12,000 cells/l. Its seasonal distribution suggests moderate light and nutrient requirements. It was found under a wide range of temperature conditions.

Nitzschia longissima was found from March through December. Principal periods of growth were late spring 1952, October 1952, mid-July 1953, and mid-September 1953. Highest concentration 31,000 cells/l. Found more often inshore.

In the 1953 and 1954 summer experiments it did well in light bottles, but it was even more successful in enriched bottles, concentrations being ten times higher than the greatest natural ones. While this response was clear-cut, one cannot discount the possibility that increased surface area provided by the bottles favored the growth of this pennate diatom. Higher temperatures, moderate to high light intensity, and enriched waters seemed favorable.

Nitzschia pungens atlantica, found from April to December 1952, appeared only in October of 1953. Highest concentration 27,000 cells/l in June 1952 and October 1953. Found more often inshore. Moderate light, moderate temperature, and at least moderate amounts of nutrient enrichment are suggested as requirements.

Thalassionema nitzschioides. Highest numbers were found in early March 1952 (Fig. 10). Other small blooms occurred from August

1952 through the spring flowering of 1953. Another peak was noted in August 1953, but there was no increase at the time of the fall flowering, and high concentrations were not found again until the spring flowering in 1954. Though continually present in Long Island Sound, it was seldom abundant enough to be classed as a dominant species. Taken slightly more often offshore.

In the 1954 spring flowering experiments, best growth was often obtained in bottles covered with four layers of gauze; good growth was also obtained in bottles enriched with P,N, and additional nutrients. In the 1954 summer experiment, good growth occurred in the bottle covered with two layers of gauze, but better growth occurred in some of the heavily enriched bottles. Growth was also obtained in enrichment experiments in summer 1953. Maximum light conditions were indicated as too high, but beyond this nothing specific can be said.

Dinoflagellates

Dinophysis acuminata was found in all months of the year except January and February. In 1952 there were small blooms in mid-April and late May. The largest numbers in both years occurred from mid-June through July, the maximum being 67,000 cells/l. In 1953 a small bloom occurred at the end of June, and a larger one took place in July, with 48,000 cells/l in one sample. Taken more often inshore.

Exuviella apora was found only from June to September. The largest concentration, at the end of June 1952, was 306,000 cells/l. A much smaller peak was found at the end of July. In 1953 small peaks occurred around the end of June and the first of September, the latter one being the larger. The distribution indicated a preference for maximum light and temperature conditions.

Peridinium elongatum was found from May through August, sometimes in numbers great enough to constitute more than 5% of the population.

Peridinium trochoideum. This species, found in trace quantities the year round, was fairly common in the warm months of the year. There was a small bloom in March 1952. The characteristic May-June flowering was much larger in 1953 than in 1952; the highest number for this period in 1952 was 141,000, in 1953 1,121,000 cells/l. Found more often inshore. It is probably significant that it was one of the

few species which did better the second year than the first during late spring and early summer.

*Prorocentrum scutellum*³ occurred from June through February, with peak concentrations in July and August. The summer bloom in 1952 was slightly larger than that in 1953. A small bloom was also found in September and October of both years. The distribution suggested that greatest abundance coincided with the seasonal maxima in temperature and probably light. Maximum concentration 600,000 cells/l in 1952. Found slightly more often offshore.

Silicoflagellates

Distephanus speculum was recorded throughout the year except for a short period in October. The largest bloom was around the end of April 1952, with a peak concentration of 109,000 cells/l. In both 1953 and 1954, small blooms took place during the spring flowering. In the spring of 1954 it did well in bottles with reduced light as well as in bottles enriched with P,N, and other nutrients, and in one experiment with raised temperature. This evidence, plus field data, indicates a preference for moderate light and temperature and at least moderate nutrient conditions.

Ebria tripartita occurred the year round, except for a short period in midfall. It exhibited best growth in August of both years, with smaller blooms in May 1952 and during the 1954 spring flowering. The summer bloom in 1952 was larger than that in 1953. Highest concentration in 1952 during this period 49,000 cells/l.

Other Forms

In Long Island Sound, a phytoplankter was quite frequently observed which may have been an aberrant dinoflagellate, but it resembled more closely a freshwater Euglena. It was nearly always found inshore, where it was taken sporadically the year round, although it was most abundant in summer. Highest concentration 217,000 cells/l. It was always associated with "red tides" in New Haven Harbor, but it was never a major red tide organism. In the experiment performed with "red water" on July 7, 1953, this species

³This may not be the correct identification of this organism. In many ways it resembles *Prorocentrum micans*, but it lacked that species' pointed apex of the cell body. Clearly identifiable *P. micans* have been found in Long Island Sound (see p. 100).

did particularly well. The initial concentration of 741,000 cells/l at least tripled in all bottles except the high salinity replicate enriched with N. It increased to ten times the initial concentration in the replicate which was enriched with N but in which the salinity was not changed. Thus requirements for high temperature and abundant light are indicated, together with good enrichment, possibly derived from shore. The optimum salinity may be below the range usually found in Long Island Sound.

MINOR SPECIES

Centrate Diatoms

Actinoptychus senarius occurred throughout the year.

**Biddulphia aurita* was found in small numbers from October through February, reached peak numbers in March, disappeared in April, and reappeared occasionally in the summer. This species consistently increased in the raised temperature experiments in the spring of 1954. It also did well in some of the gauze-covered bottles.

**Biddulphia aurita obtusa*. Small numbers in May.

Chaetoceros breve. May 1952.

Chaetoceros constrictum commonly occurred from January through April in small numbers.

Chaetoceros costatus was found the year round during periods of high nutrient concentrations.

Chaetoceros danicum occurred in greatest abundance from February through April, with lesser peaks in May and July. It was found in small numbers throughout the rest of the year.

Chaetoceros decipiens appeared in January, reached a climax in March, experienced minor blooms from May through September, and disappeared in October. It did well in N-enriched experiments.

Chaetoceros gracile was taken only in 1952. Greatest concentrations were found in March, smaller ones in July. It disappeared in August.

Chaetoceros lauderi was found only in July 1952 when it was relatively abundant.

Chaetoceros simile. March, April, and July 1952 and late winter 1954.

Chaetoceros subsecundum occurred as a trace in February and was most abundant in March.

Chaetoceros teres. Present in July and August of 1952.

**Coscinodiscus centralus pacifica* was found from June through

December, with a peak in August. This suggests a high temperature preference. It showed a significant increase in one fall experiment enriched with P.

Coscinodiscus concinnus was found mainly in August, although a few were also present in December.

**Coscinodiscus excentricus*, present in small numbers throughout much of the year, reached peak concentrations during May and October. During the latter month it was sometimes difficult to make a clear distinction between this species and large single cells of *Thalassiosira decipiens*.

Coscinodiscus lineatus was found throughout 1952, being most common in May and October.

Coscinodiscus oculus-iridis. January to April 1953.

Coscinosira polychorda. Small numbers in May 1953.

**Ditylum brightwellii* was most common in 1952; in other years it was found only as an occasional trace. In 1952 it was most abundant in March, common from April to August, and present as a trace from October to December.

Hemiaulus hauckii and *H. sinensis*. August 1952 only.

Lithodesmium undulatum. Small numbers in September and October 1953.

Melosira italica (?), like *Asterionella formosa* (see p. 93), is properly a freshwater form, but it was occasionally found in Long Island Sound, apparently in a viable condition, chiefly in the spring months after heavy rains.

Rhizosolenia calcar-avis was found as a trace in August 1952.

Rhizosolenia hebatata occurred as a trace in May 1952.

**Rhizosolenia setigera* was common the year round. Smallest numbers occurred in November and December; highest numbers were found from February to May; a small peak was also found in September. This species showed some increase in a bottle covered with six layers of gauze and in several of the bottles enriched with only one inorganic element.

Rhizosolenia styliiformis and *R. styliiformis longispina* were found in a few samples in April and May 1952.

Pennate Diatoms

Bacillaria paxillifer. May and July 1952.

Diatoma elongatum. Small numbers in the spring of 1952.

Fragillaria crotonensis. October to December 1952.

Grammatophora marina. Small numbers from October to December and from March to May.

Licmophora abbreviata and *Licmophora* spp. were found in small numbers in March, April, and September.

Navicula distans occurred from September to May, with a peak in November.

Nitzschia bilobata was found from March through July in 1952, but only in March 1953.

Nitzschia closterium was obtained from December to August, with a peak in March. In two summer experiments this species increased in bottles enriched with only N.

Nitzschia pacifica. Small numbers from May through July.

Pleurosigma normani occurred the year round, with highest concentrations in May and November.

Rhaphoneis amphiceros was found in a few samples in March and September.

Rhabdonema minutem occurred as a trace in October.

Striatella interrupta was taken in June and in the fall months, with greatest numbers in October.

Surirella fastuosa recedens. Small numbers in August and December.

Thalassiothrix frauenfeldii. March through May in 1952 only.

Dinoflagellates

Ceratium fusus occurred from May through July, with highest numbers in June.

Ceratium lineatum was found from April through August, with a peak in June and July. In a mid-June experiment in 1953 this species increased significantly only in bottles enriched with soil extract.

Dinophysis acuta was found as a trace in March 1952 and in small numbers from June through August 1953.

Dinophysis arctica. Small numbers in July and August 1952.

Dinophysis caudata. April 1953 only.

Dinophysis recurva. March 1952 only.

Exuviella baltica was taken from March through July, with a peak in May. Greater numbers were taken in 1952 than in 1953.

Glenodinium dinobryonis was present from March through August, with a peak in May and a smaller one in July.

Glenodinium gymnodinium. April and May.

Glenodinium lenticula was found from March through October, with greatest numbers from March to May 1952.

Glenodinium pilula. Small numbers from May to October; it was more abundant in 1953 than in 1952.

Glenodinium rotundum was found as a trace in May and June 1952.

Goniaulax africana (?) and *G. cochlea* (?) were the chief red tide organisms (see Conover, 1954). They were found in small numbers in the Sound, almost always at the inshore stations. Their existence in open Sound waters was marginal at best.

Goniaulax minima was found from June through September, with greatest concentrations in June. It was often associated with red tides.

Gymnodinium canus. March through June, with a June peak; also September through November.

Gymnodinium caput. April through June, with a small peak in the latter month.

Gymnodinium heterostriatum. Trace quantities in March 1952 and May 1953.

Peridinium breve. March through July, with a peak in May.

Peridinium bulla. April and May, with greatest abundance in the latter month.

Peridinium fimbriatum was found from May through July, with the highest concentrations in May. The 1953 May peak was larger than that of the year previous.

Peridinium globulus was taken from February through July, being most abundant from March to May.

Peridinium hyalinum. April through July, with peak numbers in June and July.

Peridinium minusculum. March through August, with a peak in May.

Peridinium triquetum. Small numbers from May through August.

Peridinium spp. is a general category for many individuals not easily identified. Individuals in this group were taken from March through September, but by far the greatest numbers were taken in the summer months when the other members of this genus were generally most abundant.

Prorocentrum micans. March through September, with small peaks in March and in June and July.

Prorocentrum triestinum. August through October.

Silicoflagellates

Dictyocha fibula was taken occasionally in September and January.

Coccolithophores

Individuals of this group were occasionally found; most often they resembled descriptions of the genus *Acanthoica*. They were never taken in large numbers and were found only in March and April.

Other Forms

At least two species of green or blue-green algae, one resembling *Anaebena*, were occasionally taken in the samples. They were probably freshwater forms that were washed into the Sound. They were taken most often in summer.

PHYTOPLANKTON ASSOCIATIONS

Even the most cursory glance at the previous section reveals a regular succession of important species through the annual cycle; furthermore, this succession was repeated from year to year. Of course, the two annual cycles were not exactly the same. There were slight shifts in the time of various events, and many species did not occur in the same abundance each year. The most important variations between the two years, as pointed out previously, were the greater number of dinoflagellates and the markedly smaller numbers of diatoms in the late spring and summer of 1953 as compared with 1952, and the presence of a fall flowering in 1953 which was absent the previous year.

The spring flowering was dominated by either *Skeletonema costatum* alone or by *S. costatum* and *Thalassiosira nordenskiöldii* together. Other species were typically found in significant numbers at this time as well. *Chaetoceros compressum* and *C. radians-C. tortissimum*, *Leptocylindricus danicus*, *Rhizosolenia delicatula*, *Thalassionema nitzschioides*, *Peridinium trochoideum*, and *Distephanus speculum* were abundant. *Asterionella japonica*, *Lauderia borealis*, and *Schroederella delicatula* appeared during the flowering and reached climaxes a few weeks after the main flowering peak. This was particularly striking in the case of *S. delicatula*; perhaps this species is favored by the presence of products of the decaying flowering. The actual numbers and relative importance of these spring flowering species varied from year to year.

In the spring months, another group of phytoplankton species became abundant. From April through early June, *Skeletonema costatum* persisted, as did *Chaetoceros compressum*, *Rhizosolenia delicatula*, *Thalassiosira rotula*, and *Asterionella japonica*. *Asterionella formosa* commonly occurred in the spring plankton. *Thalassiosira gravida* replaced *T. nordenskiöldii* as the most abundant member of this genus. Highest concentrations of *Distephanus speculum* occurred in April. In May, blooms of *Cerataulina pelagica*, *Guinardia flaccida*, and *Rhizosolenia fragillissima* were observed. *Peridinium trochoideum* reached highest concentrations in May and June, *Leptocylindricus danicus* in June.

Peridinium trochoideum, *Dinophysis acuminata*, and *Exuviella apora* shared dominance during late June and early July, and several species of *Ceratium* were present. In late July *Prorocentrum scutellum* became plentiful, and in 1952 the ubiquitous *Skeletonema costatum* had another bloom at this time. Early in August *Ebria tripartita* and *Rhizosolenia fragillissima* were abundant. In late August and September, *Cerataulina pelagica*, *Chaetoceros affine*, *C. compressum*, and *C. curvisetus* were found. If conditions became suitable for a small general bloom, some or all of these species dominated it. As the season progressed into October, *Corethron criophilum*, *Coscinodiscus perforatus cellulosa*, *C. radiatus*, and *Skeletonema costatum* appeared in greater numbers. *Thalassiosira gravida*, *T. rotula*, *Asterionella japonica*, and *Thalassionema nitzschioides* were taken regularly in this period as well.

Corethron criophilum, *Coscinodiscus perforatus cellulosa*, *C. radiatus*, *Thalassiosira gravida*, *T. rotula*, and *Thalassionema nitzschioides* persisted through October but occurred in diminishing numbers as the season advanced. *Rhizosolenia delicatula*, *Skeletonema costatum*, and *Peridinium trochoideum* were also common at this time. *Paralia sulcata* and *Thalassiosira decipiens*, which rapidly became dominant in late October, continued abundant through December and early January. If an October flowering occurred it was dominated by these two species plus *Skeletonema costatum*. *Thalassionema nitzschioides* also was common.

In January, other species began to succeed *Paralia sulcata* and *Thalassiosira decipiens* as conditions gradually became favorable for a spring flowering, but they continued to be found in decreasing numbers until the time of the flowering climax.

The following species occurred in markedly greater numbers in 1952 than in 1953: *Cerataulina pelagica*, *Chaetoceros compressum*, *Ditylum brightwellii*, *Eucampia zodiacus*, *Guinardia flaccida*, *Leptocylindricus danicus*, *Rhizosolenia delicatula*, *R. fragillissima*, *Skeletonema costatum*, *Thalassiosira gravida*, *Asterionella japonica*, *Nitzschia pungens atlantica*, and *Distephanus speculum*. *Peridinium elongatum*, *P. fimbriatum*, and *P. trochoideum* were more abundant in 1953 than in 1952.

ENVIRONMENTAL CONDITIONS AND THE ANNUAL CYCLE

In the marine environment there are several ecological factors which control the increase and decrease of the standing phytoplankton crop as measured by cell numbers and the amount of chlorophyll. Only one factor directly alters the number of cells in the water column, namely, grazing by herbivores; other factors operate indirectly by affecting the physiology of the cells. Of the five essentials in autotrophic plant growth and maintenance, namely carbon dioxide, water, oxygen, light energy, and nutrients, probably only the last two need be considered in Long Island Sound. However, the complexities of the oceanic environment are such that many factors influence the rate of supply of the essentials. These factors will be discussed briefly before proceeding with an analysis of the seasonal cycle.

The light available to the phytoplankton in the Sound is summarized in two ways. Fig. 7 shows the estimated incident radiation at the surface together with estimates for two other depths calculated from the formula $I_z = I_0 e^{-kz}$; I_z is the radiation in g cal/cm²/day at depth z , I_0 is incident radiation, and k is the extinction coefficient per meter as determined from Secchi disc readings, using the conversion method described by Poole and Atkins (1929). (See Riley's paper on PHYSICAL OCEANOGRAPHY in this volume.) Monthly means are given in Table II.

Light and dark bottle experiments have shown that a small amount of photosynthesis occurs at depths of 15 m or more in summer. Analyses of oxygen distribution (see Riley's paper on PRODUCTION and UTILIZATION in this volume) indicate that photosynthetic oxygen production exceeds oxygen consumption by the plankton community in the upper 10 or 15 m during summer but only in about the upper 2.5 m during winter. In the latter case particularly, the depth of water and the amount of turbulence will have an important effect

on the amount of light available for any individual cell. Optimum conditions for growth are to be found in shallow water or in deeper but vertically stable water that permits retention of cells near the surface where they can grow actively. Conversely, growth will be reduced by vertical turbulence, which has the net effect of reducing the amount of light available for each cell in the population, or by lateral mixing, which tends to reduce the shallow water population.

It is also apparent from the experimental work that inorganic nutrients, particularly nitrogen, influence the rate of increase of the population; these are probably the most important controlling factors during spring and summer.

There are two other factors which indirectly control the phytoplankton population, namely temperature and salinity. Perhaps their most obvious effect is the influence on species composition. Temperature also influences the rates of photosynthesis, nutrient uptake, and respiration (Barker, 1935a, 1935b; Hoagland, 1948; Margalef, 1954), and perhaps it affects the sinking rate by altering the viscosity of the water. Loss of cells by sinking may also be influenced by various other factors that alter the physiological state of the organisms.

Midwinter. The environment at this time was characterized by minimum radiation, decreasing temperature, slight stability and strong vertical turbulence, and large concentrations of phosphate and nitrate. Experimental measurements of daily photosynthesis of the surface phytoplankton population averaged 0.15 ml O₂/l in December and January, or about half the annual mean. In view of the small amount of phytoplankton in the water, this indicates a relatively high rate of production in the surface layer. However, the observed distribution of oxygen indicates that production exceeded consumption only in the upper few meters. Thus it seems likely that low light intensity and strong vertical turbulence were responsible for suppression of growth in the population as a whole.

The Flowering Period. A winter bloom appears to be common in Long Island Sound. The flowering here tends to be earlier than that in more exposed New England waters, such as Block Island Sound, Georges Bank, and the Gulf of Maine, but it is later than that which occurs in some very shallow protected bays (Fish, 1925; Bigelow, 1926).

In 1953 the flowering started between February 18 and 24 and culminated about March 16. The following year it was three weeks earlier. Both blooms fell within the period of gradually increasing vernal radiation. But there were no pronounced differences in the radiation pattern from one year to the next; hence the general level of radiation was significantly lower at the time of the 1954 flowering.

A slight amount of surface warming, with accompanying reduction in vertical turbulence, occurred during the 1953 flowering. In 1954, this did not occur until near the end of the bloom, and calculated values for vertical turbulence were larger than those in the flowering period of the preceding year. Thus the earliness of the 1954 flowering cannot be explained on the basis of radiation or vertical stability. There were indications of greater horizontal stability in 1954 in that the density difference between inshore and offshore waters was considerably greater than that in 1953. If the climax occurred a week earlier inshore, as is suggested by the data, then the case for the importance of horizontal stability is strengthened. Under such conditions, events in the inshore waters should be largely independent of those in the offshore environment. The effective radiation would presumably reach the critical level in the shallow water before conditions became favorable offshore, and retention of the population inshore would therefore promote an early flowering.

The magnitude of exchange between inshore and offshore waters is highly variable and has not been analyzed in quantitative terms, so that its importance in the present study cannot be evaluated precisely. It is reasonable to suppose that horizontal stability helped to promote an early flowering in 1954 but was not necessarily the major factor.

Another aspect that needs to be considered is the species composition during the flowering and the physical requirements of the dominant species. The bloom was dominated by centrate diatoms, although pennate diatoms and silicoflagellates also showed considerable growth. The two most important species were *Skeletonema costatum* and *Thalassiosira nordenskiöldii*. Both were present during the mid-winter period. As the 1953 flowering progressed, *S. costatum* became excessively dominant; at the stations sampled on March 9 it achieved a maximum concentration of 36 million cells/l compared with one million *T. nordenskiöldii*. In 1954 *T. nordenskiöldii* was relatively more important. It increased to a maximum of six million on Febru-

ary 17 while *S. costatum* achieved a peak concentration of nine million the following week. Since the former is a much larger species, it clearly dominated the early part of the flowering with respect to volume of plant material if not total numbers.

The experiments during the 1954 flowering period showed that *T. nordenskiöldii* was successful in competition with *S. costatum* at temperatures of less than 2-3° C, while the latter species was more successful at higher temperatures. There are indications too that *T. nordenskiöldii* could grow actively at lower light intensity than that required by *S. costatum*.

The experiments readily explain the observed differences in species composition in the Sound. The winter of 1953 was one of the warmest on record, and the mean water temperature was 3.2° in February and 3.7° in March. More nearly normal conditions were found in 1954, with a mean temperature of 1.7° in February. This undoubtedly favored the growth of *T. nordenskiöldii*; it is further suggested that the tolerance of this species to low light intensity was important in promoting an early flowering.

The growth coefficients indicate that the large amounts of phytoplankton at the peak of the flowering resulted from a steady population growth under favorable environmental conditions rather than from a sudden change in growth rate. Growth rates were quite high throughout this period but were not significantly higher than those at other times of the year. A graph of *K* values against time did not resemble the theoretical logistic observed in laboratory cultures, since growth rates appeared to be relatively constant so long as the population numbers were increasing. However, coefficients of oxygen production and consumption suggest that the phytoplankton was physiologically more active two weeks before the climax than on the day when maximum numbers were observed. Possibly the point designated as the climax of the flowering in Fig. 1 was actually in the early post-flowering phase, in which case senescence might explain the lower coefficient of oxygen production; however, the data from the intervening week indicate that the coefficient of oxygen production actually started to decline while the population was still increasing.

Termination of the flowering was clearly brought about by nutrient depletion. Addition of inorganic nutrients, nitrogen being the most important, restored the phytoplankton population to flowering levels within the period of the experiments except in one case, previ-

ously discussed, where the physiological state of senescence probably introduced a lag.

The zooplankton increased slightly during and after the flowering, but experiments (see R. J. Conover in this volume) indicate that the grazing factor was not sufficiently important to control the flowering. Moreover, from the peak of the bloom through the postflowering stage, maximum chlorophyll concentrations occurred at the greatest depth sampled, suggesting that the senescent diatoms were sinking to the bottom.

Spring and Summer. Small oscillations in abundance occurred from the time of re-establishment of growth after the spring flowering through August. As was mentioned above, there were distinct differences in this period between the two years, both as to size of population and species and group composition.

These facts were supplied from the weekly analyses. Radiation values continued to increase from the time of the flowering until the annual maximum in June and July. There was somewhat higher radiation in 1953 than in 1952, but variations in the monthly distribution were probably more important. In 1952 more light was available in April and May and less in June and August than in the same months of 1953. Monthly temperature averages show some differences; April and July were about the same in each year, but May was colder and June warmer in 1952. Also, there was marked salinity stratification; the salinity pattern was somewhat different in the two years as the result of spring flooding in 1953. In 1952 there was some increase in nutrients after the spring flowering, but in 1953 there was little renewal. The yearly nutrient minimum occurred in June of both years, and by August some replenishment had taken place.

Probably the most critical factor at this time of year was the supply of nutrients, although zooplankton grazing may have been critical at times. In the June 1954 experiment, chlorophyll increased to spring flowering levels in enrichment experiments. Since only simple inorganic elements were added to obtain this growth, it was concluded that these were the limiting factors. Nitrogen was found to be the most important nutrient. Since light conditions were favorable for continuous growth, nutrients were utilized by the actively growing cells as soon as they became available. Thus the upper limit of population size would be determined by the rate of

nutrient renewal. Case 4 of Braarud, *et al.* (1953) was applicable to an increasingly larger area of Long Island Sound as the days grew longer. In shallow waters the euphotic zone extends to the bottom, and a well developed bottom community (including pennate diatoms) would develop and compete with the pelagic forms for critical nutrients as they are renewed from bottom sources. Although case 1 of Braarud, *et al.* (1953) superficially resembled conditions at the deeper stations in the Sound, there was no nutrient stratification as in the Norwegian waters. Calculations based on temperature data suggest that vertical turbulence was active in spite of significant stratification (see Riley's paper on PHYSICAL OCEANOGRAPHY in this volume). The explanation for low spring and summer nutrient concentrations in the Sound would seem to be immediate utilization by plants at all levels in the water column.

The amount of light was also significantly lower in June 1952, the time of the last large diatom bloom. Experimental results suggest that light intensity may be an important factor in the competition between diatoms and dinoflagellates. In the experiment of June 1954, raw sea water of low nutrient concentration was enriched and suspended in the Sound at a depth of 0.5 m for several days. At the same time, a series of bottles containing unenriched Sound water was exposed to several different light intensities. Chlorophyll increased in some of the enriched bottles, but apparently the species favored by this enrichment were destroyed by formalin. On the other hand, diatom growth was obtained without enrichment merely by cutting down the amount of light available. The largest increase was obtained at an estimated 25% of the light available at 0.5 m. Some growth was obtained in bottles receiving even less light. Although the intensity of light appears to be important in the control of competition between diatoms and dinoflagellates, no safe generalization about the light available in the natural environment can be made without consideration of turbulence.

Temperature may also play a part in the transition from diatoms to dinoflagellates. Grøntved (1952) found that dinoflagellate replacement was delayed in the cooler year of his study. In Long Island Sound, May was cooler in 1952 than in 1953; however, the June 1952 temperature averaged warmer than 1953.

Autumn and Early Winter. Light again became the most critical factor during autumn. Not only was incident radiation decreasing

toward the annual minimum, but also strong vertical mixing by turbulence and convective cooling followed destruction of the summer thermocline.

Significant quantities of nitrate appeared in the water column in September, and phosphate, which had increased slightly during the summer, rose more rapidly in autumn. In general, nutrient regeneration exceeded utilization, but with certain exceptions that are noted below.

By the end of September, diatoms had nearly replaced dinoflagellates once again. There followed, in 1952, a gradual decrease to a minimum population in late autumn. In 1953, a small flowering in September and October was accompanied by a reduction in nutrient concentrations and this apparently led to a temporary increase in the zooplankton stock. According to Riley (unpublished data), autumn flowerings have occurred occasionally in previous years; in 1954, although none was found in the central basin, a large one was found in a limited area in the shallow water at the western end of the Sound. In deeper waters off the New England coast, such as the Gulf of Maine, there is usually a late summer or early autumn flowering of fairly large magnitude (Bigelow, *et al.*, 1940). Apparently it comes soon after the seasonal temperature maximum, when the deepening and gradual destruction of the thermocline is beginning to bring nutrient-rich water to the surface. In Long Island Sound no such store of nutrients is available in the deeper water. There must be the preliminary step of a declining phytoplankton growth rate and an excess of regeneration over utilization before there can be a sufficient stock of nutrients to support a large flowering. This occurs in late September, and by then the light intensity may be inadequate to permit a flowering in the presence of strong vertical mixing. It is pertinent in this connection to note that Harvey, *et al.* (1935) considered light as the primary factor controlling the fall flowering in the English Channel. There, as in the Sound, the flowering was of uncertain occurrence and appeared late in the season.

In comparing environmental conditions, there were no pronounced differences from one autumn to the next. During the critical period from mid-September to mid-October, the estimated average radiation was 365 g cal/cm²/day in 1952, 415 in 1953, and 335 in 1954. Differences in vertical stability and in the amount of wind were essentially negligible. It is conceivable that the biological system was so deli-

cately poised that a mere 15% difference in radiation could determine the presence or absence of an autumn bloom. However, further work is needed to check this point.

Cerataulina pelagica and several species of *Chaetoceros* have been mentioned previously as distinctive elements of the early autumn population and as dominants in the early part of the 1953 flowering. As the season progressed, other species became dominant; in the later part of the 1953 flowering, *Paralia sulcata*, *Skeletonema costatum*, and *Thalassiosira decipiens* were the most important species.

During the remainder of the autumn and early winter there was a decrease in total population and a gradual change in composition to species more suited to the autumn environment. *Corethron criophilum*, one of the species typical of early fall, showed a distinct preference in experimental bottles for strong light, high salinity and temperature, and nutrient enrichment. The two most abundant late autumn species, *Paralia sulcata* and *Thalassiosira decipiens*, thrived in dim light, nutrient enrichment, and an intermediate range of temperatures. They did not grow well in experimental bottles at temperatures approaching the seasonal minimum, and in nature they were replaced at that time by the typical midwinter flora.

ACKNOWLEDGMENTS

It is a pleasure to acknowledge the aid of the senior investigator, Gordon A. Riley. Thanks are also due G. E. Hutchinson for his interest and advice. Acknowledgment is made to Victor L. Loosanoff, Director, and Herman R. Glas, skipper of the SHANG WHEELER, of the U. S. Fish and Wildlife Service Station at Milford, Connecticut for their help in carrying out the many phases of this project. The aid of my husband, R. J. Conover, was indispensable in the preparation of the manuscript. To Jack Fu, Charles Weems, and Frank Wong I extend thanks for help in preparing the data and drawings.

Parts of this paper, chiefly the spring flowering sections, were used in an expanded form as partial fulfillment of the requirements for the degree of Master of Science, Yale University. I sincerely appreciate this opportunity, made possible through the cooperation of G. A. Riley, Daniel Merriman, Director of the Bingham Oceanographic Laboratory, and the faculty of the Zoology Department, Yale University.

REFERENCES CITED

- ATKINS, W. R. G. and P. G. JENKINS
1953. Seasonal changes in the phytoplankton during the year 1951-52 as indicated by spectrophotometric chlorophyll estimations. J. Mar. biol. Ass. U. K., 31: 495-508.
- ATKINS, W. R. G. and M. PARKE
1951. Seasonal changes in the phytoplankton as indicated by chlorophyll estimations. J. Mar. biol. Ass. U. K., 29: 600-618.
- BARKER, H. A.
1935a. Photosynthesis in diatoms. Ark. Mikrobiol., 6: 141-156.
1935b. The culture and physiology of the marine dinoflagellates. Ark. Mikrobiol., 6: 157-181.
- BIGELOW, H. B.
1926. Plankton of the offshore waters of the Gulf of Maine. Bull. U. S. Bur. Fish., 40 (2): 509 pp.
- BIGELOW, H. B., L. C. LILLICK and MARY SEARS
1940. Phytoplankton and planktonic protozoa of the offshore waters of the Gulf of Maine. Trans. Amer. phil. Soc., N. S. 31: 149-191.
- BRAARUD, TRYGVE
1945. Experimental studies on marine plankton diatoms. Norske Videnskaps-Akad., Oslo. I. Mat.-Naturv. Klasse, 1944 (10): 1-16.
- BRAARUD, TRYGVE, K. R. GAARDER and J. GRØNTVED
1953. The phytoplankton of the North Sea and adjacent waters in May 1948. Rapp. Cons. Explor. Mer, 133: 1-87.
- CONOVER, S. M.
1954. Observations on the structure of red tides in New Haven Harbor, Connecticut. J. Mar. Res., 13: 145-155.
- FISH, C. J.
1925. Seasonal distribution of the plankton of the Woods Hole region. Bull. U. S. Bur. Fish., 41: 91-179.
- GRØNTVED, J.
1952. Investigations on the phytoplankton in the southern North Sea in May, 1947. Medd. Komm. Havundersøg., Kbh., Plankton 5 (5): 1-49.
- HARVEY, H. W.
1953. Synthesis of organic nitrogen and chlorophyll by *Nitzschia closterium*. J. Mar. biol. Ass. U. K., 31: 477-487.
- HARVEY, H. W., L. H. N. COOPER, M. V. LEBOUR and F. S. RUSSELL
1935. Plankton production and its control. J. Mar. biol. Ass. U. K., 20: 407-441.
- HENDEY, N. I.
1954. A preliminary check list of British marine diatoms. J. Mar. biol. Ass. U. K., 33: 537-560.
- HOAGLAND, D. R.
1948. Lectures on the inorganic nutrition of plants. Chronica Botanica, Waltham, Mass. 225 pp.

MARGALEF, R.

1954. Modifications induced by different temperatures on the cells of *Scenedesmus obliquus* (Chlorophyceae). *Hydrobiologia*, 6: 83-94.

POOLE, H. H. and W. R. G. ATKINS

1929. Photoelectric measurements of submarine illumination. *J. Mar. biol. Ass. U. K.*, 16: 297-324.

RABINOWITCH, EUGENE

1952. Photosynthesis. *Ann. Rev. Plant Physiol.*, 3: 229-264.

RILEY, G. A.

1952. Hydrographic and biological studies of Block Island Sound. Phytoplankton of Block Island Sound, 1949. *Bull. Bingham Oceanogr. Coll.*, 13 (3): 40-64.

RODHE, W.

1948. Environmental requirements of fresh water plankton algae. *Symbolae Botan. Upsalienses*, 10 (1): 1-149.

STEEMANN-NIELSEN, E.

1937. The annual amount of organic matter produced by the phytoplankton in the Sound off Helsingør. *Medd. Komm. Havundersøg., Kbh., Plankton 3* (3): 1-37.

OCEANOGRAPHY OF LONG ISLAND SOUND, 1952-1954

V. ZOOPLANKTON

By

GEORGIANA BAXTER DEEVEY

Bingham Oceanographic Laboratory

CONTENTS

ABSTRACT.....	113
INTRODUCTION.....	114
ACKNOWLEDGMENTS.....	115
METHODS.....	115
THE ZOOPLANKTON.....	116
THE TOTAL ZOOPLANKTON.....	116
THE COMPOSITION OF THE ZOOPLANKTON.....	123
The Copepods.....	126
<i>Acartia clausi</i> Giesbrecht and <i>A. tonsa</i> Dana.....	126
<i>Temora longicornis</i> (Müller).....	131
<i>Paracalanus crassirostris</i> Dahl.....	134
<i>Oithona</i> spp.....	134
<i>Pseudocalanus minutus</i> (Krøyer).....	135
Other Copepods.....	139
Cladocera.....	140
The Larvae of Bottom Invertebrates.....	143
Other Forms.....	147
DISCUSSION.....	149
BIBLIOGRAPHY.....	154

ABSTRACT

Zooplankton samples were collected by oblique hauls with a Clarke-Bumpus sampler, using both No. 2 and No. 10 silk nets, at weekly intervals at four stations from March 1952 to March 1954. Quantitative counts have been made on only those samples obtained from March 5, 1952 to June 1, 1953, but determinations of total displacement volumes are available for the entire two year period.

The seasonal cycle in total numbers of organisms from the No. 10 net samples showed maxima in late spring and late summer, with numbers increasing in the spring and decreasing during the fall to the midwinter minimum. The largest mean total number, over 200,000/m³, was recorded in late May 1952. The No. 2 net samples revealed maximal numbers of the larger forms in April and from August to September 1952: minimal numbers were found in October and November. The mean displacement volumes obtained for the two year period were 0.95 cc/m³ for the No. 10 net hauls and 0.29 cc/m³ for the No. 2 net samples. Mean No. 10 net displacement volumes recorded for the total water column varied from 8.1 cc/m² at St. 1 to 19.8 cc/m² at St. 2.

The copepods were the major group found in the zooplankton. The larvae of bottom invertebrates were second in numbers, while several species of Cladocera and a few other forms were fairly abundant seasonally. The total number of species is limited, since most neritic forms are excluded from the Sound by the lower salinities. The important species were *Acartia clausi*, *A. tonsa*, *Temora longicornis*, *Pseudocalanus minutus*, *Paracalanus crassirostris*, and *Oithona* spp.

A comparison of displacement volumes and total numbers of organisms recorded from Georges Bank, Block Island Sound and Long Island Sound shows a tremendous increase in total numbers and a concomitant decrease in mean size of individuals in passing from offshore neritic waters to inshore neritic and then to more enclosed, less saline waters. The lower salinity of Long Island Sound favors the development of an abundant zooplankton population composed largely of small species, which furnish adequate food only for the young of various fish and for those plankton-feeding fish which are efficient filter feeders. Thus, despite the high total numbers and the relatively high volumes of zooplankton present, Long Island Sound does not support any important commercial fisheries but acts as a spawning ground and nursery for young fish.

INTRODUCTION

The collection of zooplankton samples at certain stations and at weekly intervals has been part of the program of research on the hydrography and biology of Long Island Sound. Determinations of the displacement volumes have been completed for the two years, but the material has been examined and quantitative counts have been made only for the period March 5, 1952 to June 1, 1953.

The zooplankton organisms are all euryhaline species. The range in salinity is not great, usually varying between 25 and 28‰ during the year. Although occasional specimens of the neritic species common in the open coastal waters are carried into the Sound from Block Island Sound, observations of such occurrences have been relatively rare, since these forms are unable to survive at the lower salinities. The pertinent temperature and salinity data are presented in Fig. 1 of Riley's report, PHYSICAL OCEANOGRAPHY, in this volume.

Two other investigations have also been made on the zooplankton

material, both of which are reported in this volume. Wheatland has made an intensive examination of the fish eggs and larvae obtained in these hauls, and R. J. Conover has made a special study, using both live and preserved material, of *Acartia clausi* and *A. tonsa*, the most important copepods. The present report is a general survey of the species composition and quantity of the zooplankton.

ACKNOWLEDGMENTS

The samples were collected by Gordon Riley, assisted by Shirley and Robert Conover and Howard Sanders, to all of whom it is a pleasure to express my thanks. Also, I am most grateful to Gordon Riley for determinations of the displacement volumes, but I am especially indebted to him for his considered advice, cheerfully given at any time, and for sharing with me his knowledge of oceanographic problems in general.

METHODS

The samples were obtained by oblique tows with a Clarke-Bumpus sampler, using both No. 2 and No. 10 silk nets. The hauls were made from near bottom to the surface. The weight, attached about one meter below the sampler, could be lowered to the bottom, thus avoiding contamination of the sample with bottom material. However, at the deeper stations and at St. 8 where the depth was especially irregular, it was not always feasible to fish the whole water column.

Sts. 1, 2, 5, and 8 were visited regularly. As a rule, samples were collected at Sts. 1 and 2 every week and at 5 and 8 on alternate weeks, since the distances involved were too great to visit all four stations in a day's cruise. Thus hauls were made at Sts. 1, 2, and 5 in one week and at 1, 2, and 8 the next. Usually five samples were obtained each week; No. 2 and No. 10 net tows were made at two stations and a No. 10 net haul at the third.

All the stations studied are in the central portion of Long Island Sound (see Fig. 1 in Riley's INTRODUCTION). St. 2 is approximately in the center of the Sound, while 1 is off Milford, 8 is off the Thimble Islands, and 5 is off the north shore of Long Island. Sts. 1 and 8 are inshore and 2 and 5 are offshore stations.

During cruises to the eastern and western parts of the Sound in the spring and fall of 1952 and in spring of 1953, the No. 2 net was

used for most of the zooplankton hauls, although a few No. 10 net samples were collected.

The usual procedure has been followed in making quantitative counts. A sample was diluted to a known volume and stirred thoroughly, after which 5 or 10 cc, or more, were removed to the counting chamber. The number per cubic meter was obtained by dividing the total number of organisms in the sample by the volume of water strained when the sample was collected. All of the species have not yet been identified; the species of *Oithona*, for example, were not differentiated when the counts were made, and no attempt has been made to identify many of the larvae of bottom invertebrates, such as lamellibranch veligers, polychaete larvae, etc.

The total displacement volumes were obtained by straining the samples on a filter of No. 20 bolting silk, washing them several times with tap water, and removing the excess water by placing the silk on filter paper or some other absorbent surface for several minutes. The organisms were then removed from the silk with a thin spatula and put into a measured volume of water to obtain the displacement volume. Such determinations were made on all of the samples, except for some collected during February and March in 1953 and 1954 when too much phytoplankton was present to allow accurate determinations to be made.

THE ZOOPLANKTON

THE TOTAL ZOOPLANKTON

The mean total numbers of zooplankton organisms per cubic meter taken with the No. 2 and No. 10 nets from March 5, 1952 to June 1, 1953 are shown in Fig. 1. It is immediately apparent how small a proportion of the total population was sampled by the No. 2 net. Only in April 1952 did the numbers of No. 2 net organisms exceed 20,000/m³, while numbers of over 200,000/m³ were obtained by the No. 10 net hauls in late May 1952; mean total numbers of over 100,000/m³ were found during most of the period from late May through mid-September.

Comparison of the No. 10 net data for individual stations showed that total numbers of over 200,000/m³ were recorded only at Sts. 1 and 2. At St. 2 the maximal number of 213,000/m³ was obtained in mid-August, while at St. 1 total numbers of 258,000/m³, the highest re-

corded thus far in this survey, were found in early September. Nevertheless, the late summer maximum is not shown as strikingly in Fig. 1 as the late spring maximum. This is because a great increase took place simultaneously at all four stations in late May and early June, whereas the time of occurrence of the late summer maximum varied from station to station. The data obtained for St. 8 differed from those recorded for the other stations in that there was no marked increase in total numbers during the late summer; the numbers

TABLE I. MEAN MONTHLY TOTAL NUMBERS OF ZOOPLANKTON PER CUBIC METER AND PER SQUARE METER IN LONG ISLAND SOUND, 1952-1953.

	Mean Total Numbers per Cubic Meter				Mean of All Stations	
	Station 1	Station 2	Station 5	Station 8	Total No. per M ³	Total No. per M ²
March	11,750	25,875	41,730	21,000	25,675	475,950
April	43,980	65,300	25,600	31,750	44,255	725,000
May	110,920	111,510	104,500	115,600	111,200	1,729,800
June	210,900	142,500	111,600	100,400	161,385	2,230,330
July	70,275	83,840	76,615	77,070	77,000	1,230,540
August	107,555	152,070	108,700	84,025	114,715	1,890,220
September	145,680	80,575	85,400	40,200	105,140	1,507,970
October	27,730	19,290	65,750	36,900	31,180	507,405
November	29,655	32,735	38,800	24,000	31,350	529,800
December	11,840	15,090	23,600	8,870	14,325	238,060
January	8,530	10,530	15,575	9,500	10,635	189,365
February	16,475	14,665	26,900	28,800	19,560	347,000
March	15,400	44,400	61,975	—	45,940	1,093,310
April	49,300	72,000	68,900	8,050	53,430	1,140,180
May	97,370	83,135	64,000	43,150	76,870	1,153,400

increased abruptly to nearly 200,000/m³ in late May and then declined gradually to the seasonal minimum in late December.

Table I gives the mean monthly total numbers of the No. 10 net samples for Sts. 1, 2, 5, and 8; also given are the mean monthly numbers per cubic meter and per square meter of sea surface obtained by averaging the data from all No. 10 net hauls. At all stations the total numbers increased abruptly from April to May and remained high during June. High numbers were recorded during August at Sts. 2 and 5 and in August and September at St. 1. The decrease from September to October was particularly marked at Sts. 1 and 2. Minimal numbers were found in December and January, but through-

out the fall and winter the mean monthly numbers were somewhat greater at St. 5 than at the shallower stations. The yearly cycle, as revealed by the No. 10 net samples of 1952 to 1953, showed essentially a single maximum during the warmer months, the numbers increasing in the spring and decreasing in the fall to the mid-winter minimum.

The data for Sts. 1 and 2 at depths of 9 and 20 m respectively may be used to compare the total numbers of organisms per square meter of sea surface in the inshore and offshore waters. As expected, the numbers were approximately twice as large at the deeper station, where over 4,000,000/m² were found in August. Even at St. 1, over 2,000,000/m² were recorded in late spring and late summer. These figures are high when compared with those obtained for Block Island Sound (Deevey, 1952a) where the mean depth is 30 m; the highest numbers there did not exceed 1,000,000/m² of sea surface.

The No. 2 net samples (see Fig. 1) showed that maximal numbers of the larger forms were found during April and from mid-August to mid-September. Only in April 1952 did the numbers taken in the No. 2 net hauls exceed by a few hundred those obtained in the No. 10 net samples. The highest mean number, recorded in April 1952, was a little over 30,000/m³, twice the highest number found in April 1953. During October and November minimal numbers were present; from December onwards the totals increased gradually to the April maximum.

The mean total zooplankton displacement volumes obtained for the No. 2 and No. 10 net samples from March 1952 to March 1954 are shown in Fig. 2. For a comparison of the seasonal cycles of phosphate, nitrate, chlorophyll, and the No. 10 net volumes from the inshore and offshore stations, see Riley and Conover's accompanying report, CHEMICAL OCEANOGRAPHY. The quantity of zooplankton was considerably greater in 1952 than in 1953. It is probable, however, that such fluctuations in quantity occur from year to year in these waters.

The No. 10 net volumes showed a pronounced maximum in August and September 1952, similar to that recorded for the total numbers. This was the period when *Acartia tonsa* was most abundant and when a variety of crustacean larvae were present. Nevertheless, it is not clear, from the composition of the population, why the late summer volumes should have been so much greater than those obtained

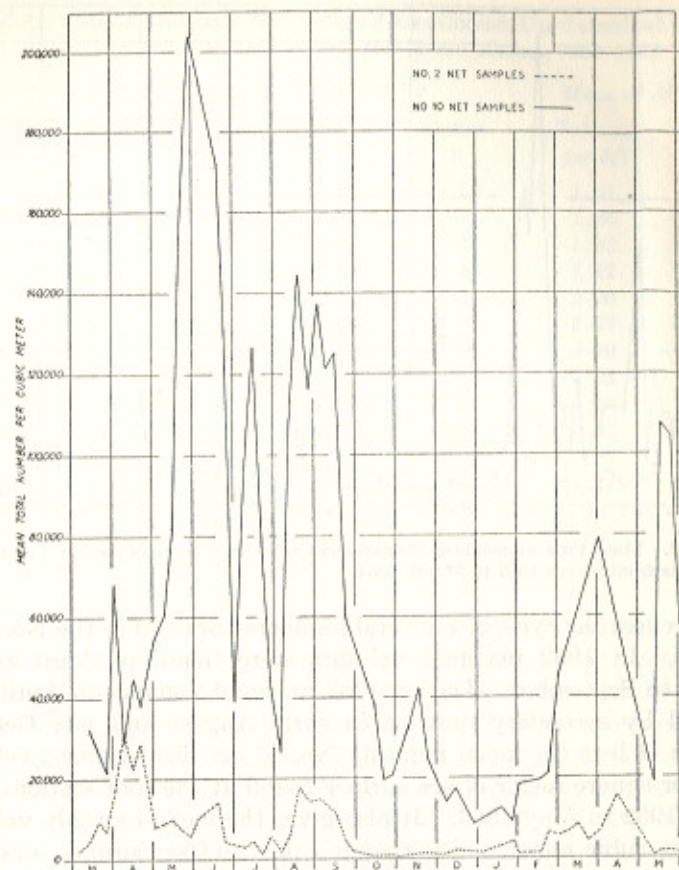

Figure 1. Mean total numbers of zooplankton per cubic meter taken with the No. 2 and No. 10 nets from March 5, 1952 to June 1, 1953.

earlier in the summer of 1952. The maximum in May 1952 may reflect, at least in part, the greater number of late-stage copepods present at this time which were responsible for the bursts of nauplii in early June. In 1953 a maximum in both numbers and volumes was found in early April. Since the samples obtained after June 1, 1953 have not been studied, it is not possible to compare total numbers with the much smaller volumes found in August and September 1953.

The seasonal cycle of the No. 2 net volumes (see Fig. 2) more

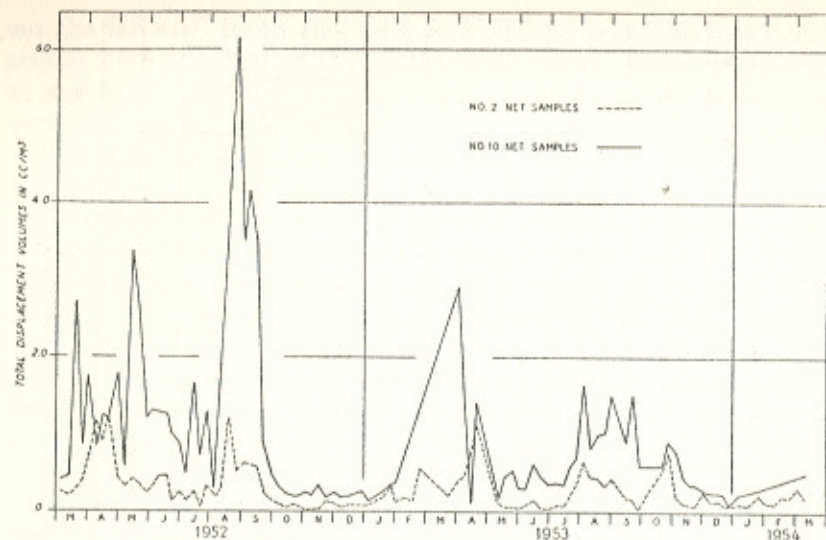

Figure 2. Mean total zooplankton displacement volumes in cc/m^3 of the No. 2 and No. 10 net samples from March 1952 to March 1954.

nearly reflect the cycle of the total numbers obtained in the No. 2 net samples. In 1952 maximal volumes were found in April and in August to September. During 1953 maximal volumes in April were followed by secondary maxima in early August and late October.

Table II lists the mean monthly No. 10 net displacement volumes in cc per square meter of sea surface found at the four stations from March 1952 to May 1953. It also gives the mean monthly volumes in cc per cubic meter and per square meter of sea surface, obtained by averaging all the No. 10 net data for this period. The individual station data can be converted into volumes per cubic meter by dividing by the station depths: 9 m for St. 1, 20 m for St. 2, 27 m for St. 5, and 12 m for St. 8. Presenting the station volumes as cc per square meter of sea surface makes it possible to compare quickly the total quantities found at the four stations during the year. At St. 1 the mean monthly volumes did not exceed $30 \text{ cc}/\text{m}^2$, but on several occasions at St. 8 exceptionally high volumes were obtained in 1952. Since considerable phytoplankton was present at St. 8 during the months in question, this may have contributed to the higher volumes. At the deeper stations, monthly volumes greater than $40 \text{ cc}/\text{m}^2$ were found only during August and September.

TABLE II. MEAN MONTHLY NO. 10 NET ZOOPLANKTON DISPLACEMENT VOLUMES IN CC PER SQUARE METER AND PER CUBIC METER, 1952-1953

	Mean Volumes per Square Meter				Mean of All Stations	
	Station 1	Station 2	Station 5	Station 8	Volumes per M^2	Volumes per M^3
March	6.30	12.20	16.88	55.20	1.21	17.99
April	13.20	33.60	16.07	11.52	1.26	19.56
May	10.73	36.64	23.67	47.44	1.92	28.45
June	11.40	21.30	26.19	10.92	1.12	16.27
July	7.47	13.84	11.20	26.40	1.00	13.88
August	28.87	86.00	41.58	49.80	3.37	50.57
September	23.87	59.50	93.15	3.96	2.70	45.63
October	1.89	4.00	11.07	2.58	0.23	3.77
November	2.12	5.25	7.16	2.04	0.24	3.99
December	1.71	2.87	6.48	3.60	0.21	3.33
January	1.73	8.10	5.80	4.20	0.26	4.33
February	—	9.40	7.29	—	0.37	8.35
March	—	—	—	—	—	—
April	11.70	5.80	40.50	1.44	0.80	14.86
May	3.30	9.20	12.42	3.18	0.39	6.25

The total volumes recorded for the No. 10 net samples yielded a mean annual concentration of $1.25 \text{ cc}/\text{m}^3$ for the period from March 1952 to March 1953. This is twice the mean volume of $0.61 \text{ cc}/\text{m}^3$ obtained from March 1953 to March 1954. For the two years, 235 determinations gave a mean concentration of $0.95 \text{ cc}/\text{m}^3$ for the No. 10 net samples. The No. 2 net zooplankton yielded a mean volume of $0.32 \text{ cc}/\text{m}^3$ for 1952 to 1953 and of $0.26 \text{ cc}/\text{m}^3$ for 1953 to 1954. The mean concentration obtained from 225 No. 2 net samples was $0.29 \text{ cc}/\text{m}^3$ for the two year period.

Table III summarizes the mean annual volumes recorded for the four stations. At each station the mean volumes obtained in 1953 to 1954 were smaller than those found during the first year. The volumes recorded for Sts. 1 and 2 are fairly similar. The smallest means were usually found at St. 5; also, at this station the difference between the two years was not as great. As previously noted, exceptionally large volumes were noted on several occasions in 1952 at St. 8; as a result the largest mean volume for 1952 to 1953 was obtained at this station. For the two year period, the No. 2 net volumes recorded for Sts. 1, 2, and 5 were one third as great as the No. 10 net volumes.

TABLE III. THE MEAN TOTAL ZOOPLANKTON DISPLACEMENT VOLUMES, IN CC/M³, AND THE ESTIMATED TOTAL ZOOPLANKTON CROP IN CC/M³ OF SEA SURFACE AT STATIONS 1, 2, 5 AND 8 IN LONG ISLAND SOUND, 1952-1954

	Mean Displacement Volumes in CC/M ³			Mean Zooplankton Crop in CC/M ³
	1952-1953	1953-1954	1952-1954	
Station 1				
No. 2 net	0.38	0.20	0.30	2.70
No. 10 net	1.16	0.59	0.90	8.10
Station 2				
No. 2 net	0.35	0.25	0.30	6.00
No. 10 net	1.33	0.62	0.99	19.80
Station 5				
No. 2 net	0.27	0.22	0.24	6.48
No. 10 net	0.86	0.56	0.72	19.44
Station 8				
No. 2 net	0.34	0.28	0.31	3.72
No. 10 net	1.95	0.52	1.24	14.88

When estimates are made of the mean zooplankton crops produced at the several stations during the two years, the results vary considerably due to the range of station depths (see Table III). Thus St. 1 yielded a mean volume of 8.1 cc/m³ for the No. 10 net samples, while the volumes recorded for Sts. 2 and 5 were 19.8 and 19.4 cc/m³, respectively. The mean volumes obtained for the No. 2 net samples varied from 2.7 at St. 1 to 6.5 cc/m³ at St. 5. When these figures are compared with those obtained from Block Island Sound¹ (Deevey, 1952a), it is apparent that the mean crop produced in Long Island Sound is probably no greater than that of Block Island Sound. This is rather surprising, since the highest number taken by the No. 10 net in Block Island Sound scarcely exceeded 30,000/m³, approximately the highest number retained by the No. 2 net in Long Island Sound. This excessive difference in total numbers coupled with similar displacement volumes indicates that the mean size of the organisms of Long Island Sound is considerably smaller than that of the zooplankton of Block Island Sound.

¹ Mean displacement volumes from Block Island Sound were: 0.68 cc/m³ and 20.4 cc/m³ for No. 10 net samples; 0.21 cc/m³ and 6.4 cc/m³ for No. 2 net samples.

THE COMPOSITION OF THE ZOOPLANKTON

The copepods were by far the dominant organisms. Only during May, June, July and September were appreciable quantities of other forms present. As a group, the larvae of bottom invertebrates ranked next in numbers; Cladocera were also important at all the stations. As previously noted, the dominant copepods were *Acartia clausi* and *A. tonsa*. *Temora longicornis*, *Pseudocalanus minutus*, *Paracalanus crassirostris*, and *Oithona* spp. also occurred in numbers during the year in both the No. 2 and No. 10 net hauls, while *Centropages hamatus*, *Labidocera aestiva* and *Pseudodiaptomus coronatus* constituted 5% or more of at least one of the No. 2 net samples. Three species of Cladocera, *Podon polyphemoides*, *Evadne nordmanni*, and *Penilia avirostris*, were obtained in numbers in the No. 2 and No. 10 net tows. The following types of larvae of bottom invertebrates made up 5% or more of at least one No. 2 or No. 10 net sample: barnacle nauplii, *Balanus balanoides* cyprids, lamellibranch veligers, gastropod veligers, echinoderm larvae, polychaete larvae, and mysid larvae. Aside from these forms, *Oikopleura dioica* and rotifers were the only other organisms that were fairly abundant seasonally.

Fig. 3 shows the total numbers of the several groups of organisms taken with the No. 10 net at St. 2. The relative proportions of the groups were similar at all stations. During most of the year, the copepods (including nauplii) constituted at least 80% of the population. Bottom larvae were abundant in May, June, July and September, while Cladocera were most numerous at the beginning of summer and again in September. Rotifers were largely responsible for the early April 1953 maximum of miscellaneous organisms. The composition of the No. 2 net zooplankton at St. 2 is shown in Fig. 4. Copepods constituted an even higher percentage of the No. 2 net hauls. Bottom larvae were not taken in quantity, and Cladocera were most numerous in June. The variety of zooplankton organisms is obviously not great.

The percentage composition of the copepod population found in the No. 10 net hauls at St. 2 is presented in Fig. 5, where the sequence of the important species during the year is clearly illustrated. *Acartia clausi*, *Temora longicornis*, and *Pseudocalanus minutus* occurred during the winter and spring. In July there was an abrupt change in the species composition as *Acartia tonsa*, *Paracalanus crassirostris*, and

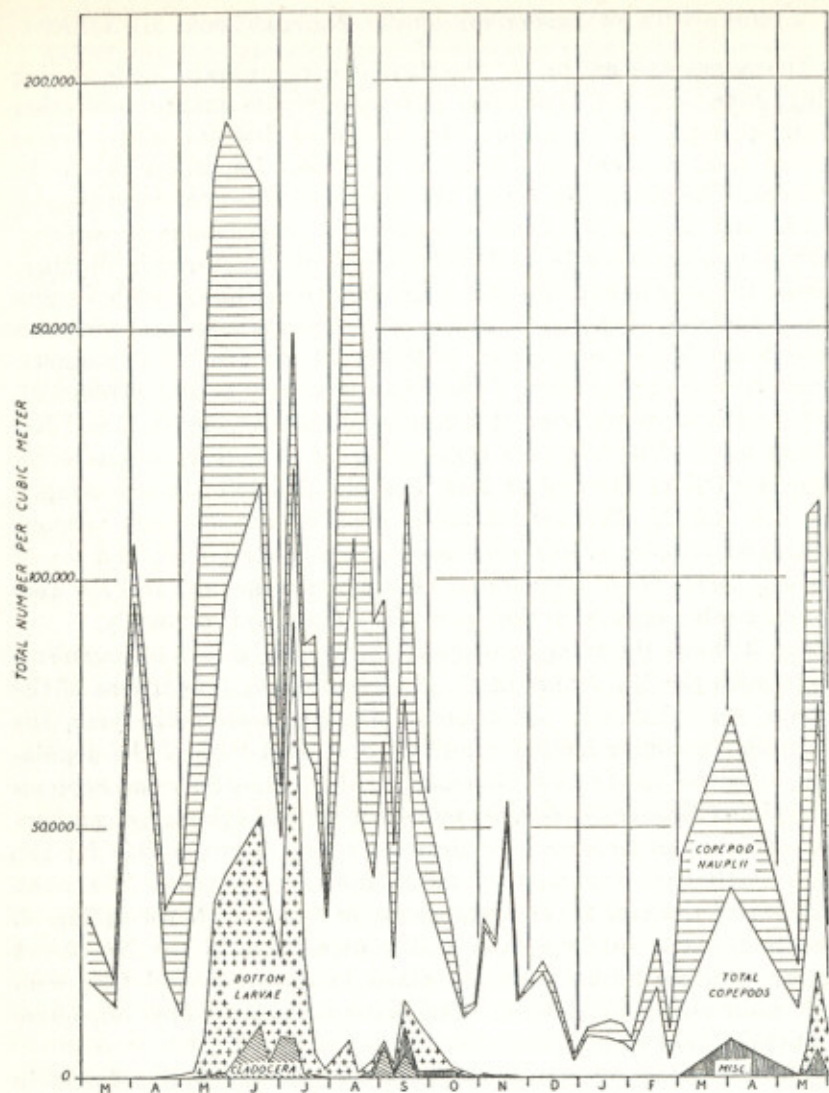

Figure 3. Total numbers per cubic meter of the different groups of organisms obtained in the No. 10 net hauls at St. 2 from March 1952 to June 1, 1953. The numbers of the groups are cumulative, the top line representing total numbers of zooplankton.

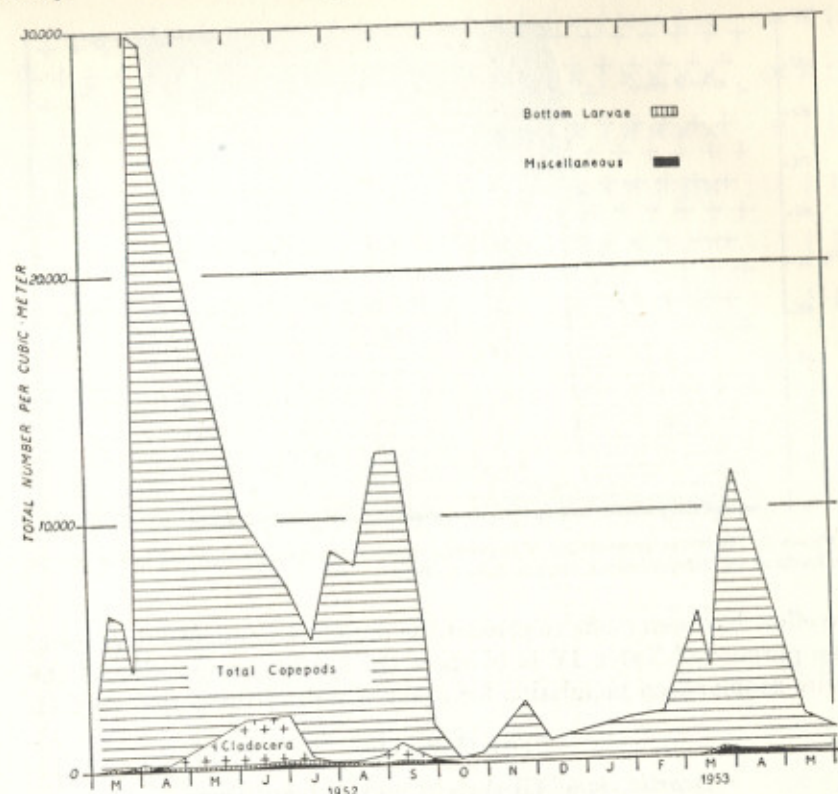

Figure 4. Total numbers per cubic meter of the different groups of organisms taken in the No. 2 net samples at St. 2 from March 1952 to June 1, 1953. The numbers of the groups are cumulative, as in Fig. 3.

Oithona spp. appeared and rapidly increased in numbers while the earlier species disappeared. In December the winter to spring species reappeared and began slowly to increase in abundance, while the summer and fall species dwindled in numbers during the winter months. Thus the winter change-over in species was much more gradual than the one that occurred in July. All of the other species of copepods combined, included in Fig. 5 as "Miscellaneous," were never of numerical importance.

Table IV gives a checklist of the species found in Long Island Sound. If a single specimen of a species was found in one sample at one station during the month, a check indicates its presence at that time.

TABLE IV. (Continued)

	1952										1953					
	M	A	M	J	J	A	S	O	N	D	J	F	M	A	M	J
CLADOCERA (Continued)																
<i>P. intermedius</i>	—	—	—	×	×	—	—	×	—	—	—	—	—	—	—	—
<i>Penilia avirostris</i>	—	—	—	—	×	×	×	×	—	—	—	—	—	—	—	—
<i>Bosmina</i> sp.	—	—	—	×	—	—	×	×	—	—	×	—	—	—	×	×
<i>Daphnia</i> sp.	—	—	—	—	—	—	—	—	—	—	—	—	—	—	—	×
CRUSTACEAN LARVAE																
<i>Balanus balanoides</i> nauplii	×	×	—	—	—	—	—	—	—	—	×	×	×	×	—	—
<i>B. balanoides</i> cyprids	×	×	×	—	—	—	—	—	—	—	×	×	×	×	×	—
Other barnacle larvae	—	—	×	×	×	×	×	×	—	—	×	×	×	×	×	—
Mysid larvae	×	×	×	×	×	—	×	×	×	×	×	×	×	×	×	—
Cumacean larvae	—	—	—	—	—	—	—	—	—	—	×	×	×	×	×	—
<i>Squilla</i> pseudozoeae	—	—	—	—	×	×	×	×	—	—	—	—	—	—	—	—
Microniscus larvae	—	—	—	—	—	—	×	×	—	—	—	—	—	—	—	—
Larval gammarids	—	—	×	—	×	—	—	×	×	—	—	—	—	—	—	—
Caprellids	—	—	—	—	—	—	×	—	—	—	—	—	—	—	—	—
Hyperiid amphipods	—	×	—	—	—	—	—	—	—	—	—	—	—	—	—	—
Larval <i>Crago</i>	×	×	×	×	×	×	×	×	×	×	—	—	—	—	—	—
<i>Hippolyte</i> larvae	—	—	—	×	×	—	—	—	—	—	—	—	—	—	—	—
<i>Upogebia</i> larvae	—	—	—	—	×	×	×	×	—	—	—	—	—	—	—	—
<i>Eupagurus</i> larvae	—	—	—	×	×	×	×	×	×	—	—	—	—	—	—	—
Porcellanid larvae	—	—	—	—	—	—	—	—	—	—	—	—	—	—	—	—
<i>Cancer irroratus</i> zoeae	—	—	×	×	×	×	—	×	—	—	—	—	—	—	×	×
<i>Callinectes sapidus</i> zoeae	—	—	—	×	×	×	×	×	—	—	—	—	—	—	×	×
<i>Pinnixa</i> sp. zoeae	—	—	—	—	×	×	×	×	—	—	—	—	—	—	—	—
<i>Libinia</i> sp. zoeae	—	—	—	—	×	×	×	×	—	—	—	—	—	—	—	—
<i>Neopanope texana sayi</i> zoeae	—	—	—	—	×	×	×	×	—	—	—	—	—	—	—	—
<i>Pelia mutica</i> zoeae	—	—	—	—	—	—	×	×	—	—	—	—	—	—	—	—

TABLE IV. (Continued)

	1952										1953					
	M	A	M	J	J	A	S	O	N	D	J	F	M	A	M	J
CRUSTACEAN LARVAE (Cont.)																
<i>Pinnotheres maculatus</i> zoeae	—	—	—	—	—	—	—	×	—	—	—	—	—	—	—	—
Post-larval <i>Pinnotheres</i> sp.	—	—	—	—	—	×	—	×	—	—	—	—	—	—	—	—
Megalops larvae	—	—	—	—	—	×	×	×	—	—	—	—	—	—	—	—
OTHER LARVAL FORMS																
Echinoderm larvae	—	—	—	×	×	×	×	—	—	—	—	—	—	—	—	—
Cyphonautes larvae	×	×	—	×	—	×	×	×	—	—	—	—	—	×	—	—
Gastropod veligers	—	×	×	×	×	×	×	×	×	×	×	—	—	—	—	×
Lamellibranch veligers	×	×	×	×	×	×	×	×	×	—	—	×	×	×	×	×
Squid larvae	—	—	—	—	—	×	×	×	—	—	—	—	—	—	—	—
POLYCHAETES																
Polychaete larvae	×	×	×	×	×	×	×	×	×	×	×	×	×	×	×	×
<i>Autolytus</i> sp.	×	—	×	×	—	—	×	×	—	—	—	—	—	×	×	×
<i>Tomopteris</i> sp.	—	—	—	—	—	—	—	—	—	—	—	—	×	—	—	—
COELENTERATES																
Hydromedusae	×	×	×	×	×	×	×	×	×	×	×	×	×	×	×	×
Actinuli	—	—	—	—	—	—	×	×	—	×	—	—	×	×	—	—
Siphonophores	—	—	—	—	—	—	—	—	×	—	—	—	—	—	—	—
OTHER FORMS																
<i>Sagitta elegans</i>	×	×	×	×	×	—	—	×	×	×	×	×	×	×	×	—
<i>Oikopleura dioica</i>	—	—	—	—	—	×	×	×	×	—	—	—	—	—	—	—
<i>Fritillaria</i> sp.	—	—	—	—	—	—	—	—	—	—	—	—	—	×	—	—
Rotifers	×	×	×	—	—	—	—	—	×	—	—	×	×	×	×	×
Nematodes	—	—	—	—	—	—	×	×	—	—	—	—	—	×	×	×
Fish eggs	×	×	×	×	×	×	×	×	—	—	—	—	×	×	×	×
Fish larvae	×	×	×	×	×	×	×	×	×	×	×	×	×	×	×	—

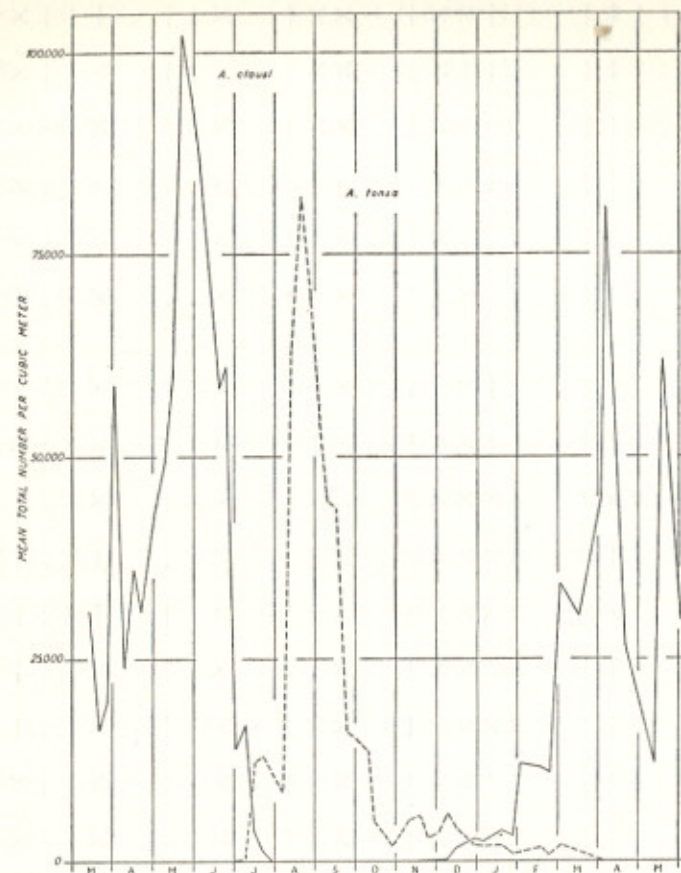

Figure 6. Mean total numbers of *Acartia clausi* and *A. tonsa* per cubic meter taken in the No. 10 net samples from March 1952 to June 1, 1953.

tually disappeared from the samples. In July the numbers began to increase and *A. tonsa* replaced *A. clausi* as the dominant species. The numbers of *A. tonsa* increased abruptly during August to their seasonal maximum, then declined rapidly in September. *A. tonsa* remained an important form during the fall, although it was exceeded in numbers by *Paracalanus crassirostris* and *Oithona* spp. (see Fig. 5). Late stages were present in small numbers throughout the winter and early spring months.

Judging from the total numbers recorded for the two species during

the year, *A. clausi* is better adapted to living in the waters of Long Island Sound than *A. tonsa*. An influx of ctenophores, appearing in early September 1952 and continuing during that month, may have been partially instrumental in lowering so drastically the numbers of *A. tonsa*, or it may be that *A. tonsa*, primarily an inhabitant of warmer waters, is incapable of reproducing in large numbers except during the warmest months at the northern limits of its range.

Temora longicornis (Müller)

This species ranked third in numbers. Its seasonal cycle, closely following that of *Acartia clausi*, was similar to that previously described (Deevey, 1952a) for Block Island Sound. However, it was more abundant in Long Island Sound. Fig. 7 shows the mean total numbers of *T. longicornis* recorded from the No. 10 net samples. In 1952 the numbers remained fairly low until mid-May, when there was an abrupt increase to a maximum in late May and June. The highest number obtained was approximately 100,000/m³ at St. 1 during the third week of June. Total numbers decreased sharply in late June, and by the beginning of August it had disappeared. It

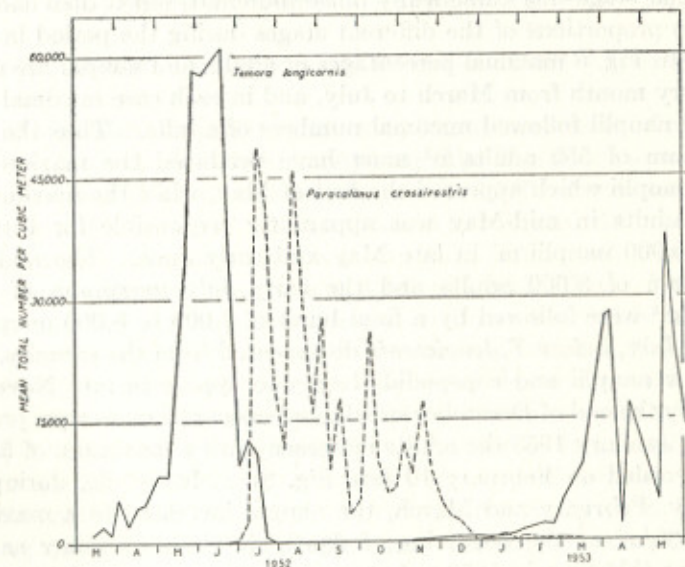

Figure 7. Mean total numbers per cubic meter of *Temora longicornis* and *Paracalanus crassirostris* taken in the No. 10 net samples from March 1952 to June 1, 1953.

reappeared in November and was present in small numbers until the end of February, but during March it began to increase and reached a maximum in early April. A second maximum occurred in mid-May, and then it declined in numbers up to the first of June. Obviously, both *T. longicornis* and *Acartia clausi* were similarly affected by whatever factors were responsible for the differences in total numbers observed between the springs of 1953 and 1952.

Since only portions of two seasonal cycles have been studied, and since the data for the two years varied considerably, it is difficult to determine the probable number of generations per year. From March to the end of July 1952, excepting July 1, nauplii constituted 40% or more of the total numbers, and reproduction probably occurred continuously during winter and spring until the population attained the high numbers recorded in late May and June. However, when the various developmental stages are plotted as percentages of the total number, as in Fig. 8, three and possibly four major maxima of nauplii are apparent between March and the end of July 1952. Such a graph is deceptive in that the time of occurrence of a higher percentage of a certain stage may not coincide with the date when that particular stage was numerically most abundant, but it does show the relative proportions of the different stages during the period in question. In Fig. 8 maximal percentages of adults and nauplii are shown for every month from March to July, and in each case maximal numbers of nauplii followed maximal numbers of adults. Thus the April maximum of 550 adults/m³ must have produced the maximum of 5,600 nauplii which appeared the first of May, while the maximum of 1,500 adults in mid-May was apparently responsible for totals of over 40,000 nauplii/m³ in late May and early June. The mid-June maximum of 3,000 adults and the early July maximum of 4,400 adults/m³ were followed by a final burst of 7,000 to 8,000 nauplii/m³ in mid-July, before *T. longicornis* disappeared from the samples.

A few nauplii and copepodids began to appear in late November 1952; by the end of December small numbers of all stages were present. During January 1953 the adults increased until a maximum of 550/m³ was recorded on February 10 (see Fig. 8). Meanwhile, during late January, February and March, the nauplii increased to a maximum of 22,000/m³ at the beginning of April, six times as many as were found at this time in 1952. A second adult maximum also occurred in late March and early April, although the numbers of nauplii were

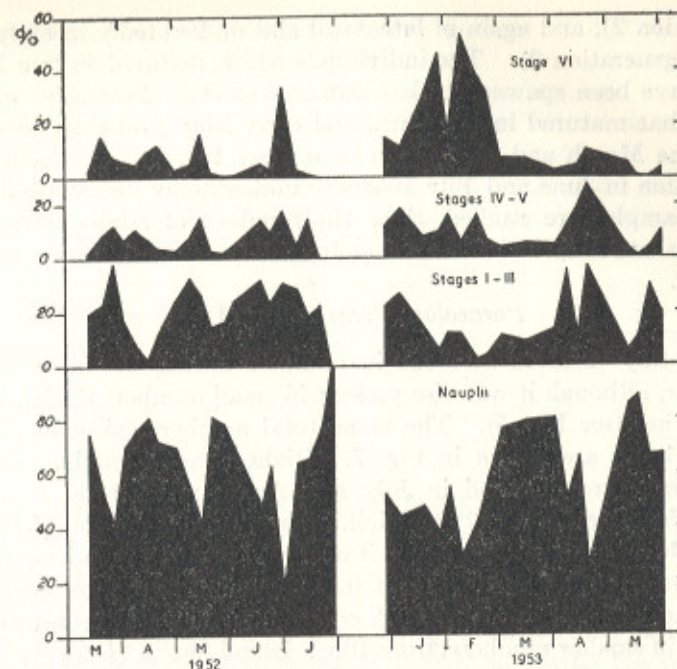

Figure 8. Relative percentages of nauplii and copepodid stages of *Temora longicornis*.

sufficiently high to obscure the early April maximum of stage VI *T. longicornis*. During April, many stage I to V individuals were present, and the highest number of adults, over 1,700/m³, was recorded on April 20. Unfortunately, no samples were collected during the next three weeks, when the ship was in drydock, but it is obvious that an adult maximum occurred in late April and early May. The second major maximum of over 33,000 nauplii/m³ was recorded in mid-May.

Several generations were produced during the months when *T. longicornis* was present, but the spacing of the broods and possibly the number may vary from year to year. In January and February 1953 the adult stock was gradually augmented to form adult generation 1 by the development of nauplii and copepodids which appeared in November and December. Spawning continued at a low level during midwinter, but in late February the nauplii had increased to approximately 1,000/m³ and by mid-March to nearly 8,000. Maximal numbers of adults also occurred in late March and early April (adult

generation 2), and again in late April and undoubtedly in early May (adult generation 3). The individuals which matured in late March may have been spawned in late January or early February, whereas those that matured in late April and early May probably developed from the March and early April brood (see Fig. 8). A fourth adult generation in June and July 1953 will undoubtedly be recorded when those samples are studied, since the numbers of adults were rising again in late May and since a final June-July generation was observed in 1952.

Paracalanus crassirostris Dahl

This tiny calanoid occurred in numbers during the latter half of the year, although it was also present in small numbers during winter and spring (see Fig. 5). The mean total numbers taken in the No. 10 net hauls are shown in Fig. 7. Highest mean numbers of over 45,000/m³ were obtained in July and August; thereafter *P. crassirostris* decreased gradually to minimal numbers by the end of December. During the spring of 1952 it occurred in small numbers, usually more than 100/m³, but in 1953 it was not found in the routine counts after the beginning of April. *P. crassirostris* has also been recorded, though in smaller numbers, from Block Island Sound (Deevey, 1952a) where it was observed from August to early February, with maxima in August and from October to December. In Long Island Sound it was found equally at all four stations, offshore as well as inshore. The highest total, 66,000/m³, was obtained at St. 2 in the center of the Sound in mid-August, while the next highest, 59,000, was noted in mid-July at St. 1. No attempt has been made to differentiate the developmental stages of this species. Only the numbers of the copepodid stages are plotted in Fig. 7.

Oithona spp.

The total numbers taken in the No. 10 net tows are presented in Fig. 9. The species have not been differentiated, but possibly three are included in these counts, *O. similis*, *O. brevicornis*, and *O. nana*. *Oithona* was found throughout the year (see Table IV). Minimal numbers were noted during the spring of 1952, but beginning in July and continuing in August the numbers increased to approximately 29,000/m³ in September. It then gradually decreased in quantity during the fall months, with relatively high numbers recorded in

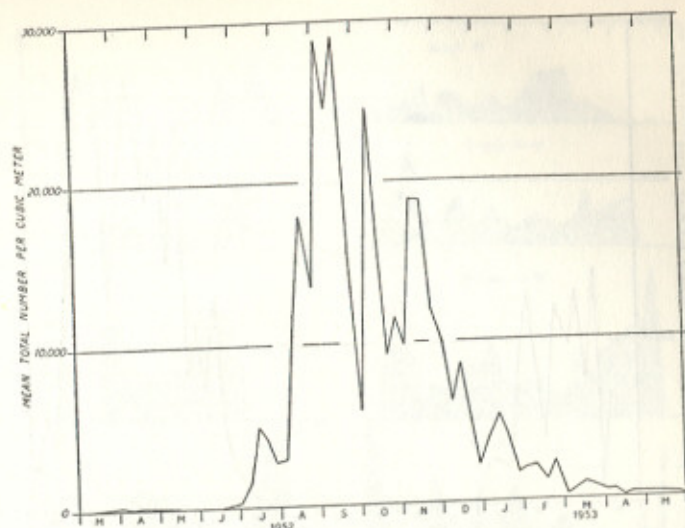

Figure 9. Mean total numbers of *Oithona* spp. per cubic meter obtained in the No. 10 net hauls.

October and again in November. *Oithona* occurred in appreciably larger numbers during the spring of 1953 than during the preceding spring. The species of *Oithona* thus exhibited a seasonal cycle similar to that of *Paracalanus crassirostris* (see Fig. 5). Maximal numbers were found at St. 1, the highest number being 46,000/m³ in early September, but it was also abundant at the other stations. During the fall months *Oithona* and *Paracalanus crassirostris* were of greater numerical importance than *Acartia tonsa*.

Pseudocalanus minutus (Krøyer)

This species occurred during winter and spring (see Fig. 5). Although its seasonal cycle resembled that of *Temora longicornis*, it was never as abundant. Fig. 10 shows the mean total numbers taken in the No. 10 net hauls. *P. minutus* was found in larger numbers in 1953 than in 1952. Maxima of nearly 3,000/m³ were noted in early April and of over 2,500/m³ in the latter part of May 1952. Small numbers were observed in June and it disappeared early in July. A few individuals were recorded in early December, and by the end of December all stages were present. The numbers increased during January 1953; in February, March and April maxima

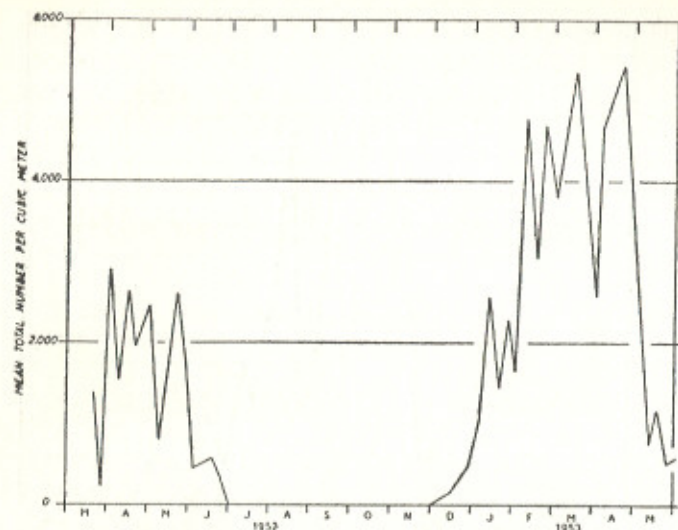

Figure 10. Mean total numbers of *Pseudocalanus minutus* per cubic meter taken in the No. 10 net samples.

of 4,500 to 5,500/m³ were found. However, the numbers decreased abruptly between late April and early May, so that *P. minutus* was not nearly as abundant in May 1953 as it had been in May 1952. As previously noted, this was also true of *Temora longicornis* and *Acartia clausi*.

Fig. 11 shows the percentage composition of the developmental stages in 1952 and 1953. Between March and July 1952, two major spawning periods are evident. The numbers of adults were low, the highest number (175/m³) occurring in mid-May, but judging from the relative percentages and the numbers of nauplii and of stages I to III, spawning occurred primarily during April and late May when nauplii were most abundant. Stages I to III were most numerous in early April and late May; none were observed after mid-June. Stages IV and V were also last recorded in mid-June, but a few females remained until the first of July. Nauplii were not numerous after the end of May. The mid-July maximum of nauplii shown in Fig. 11 is deceptive, since it represents only the small numbers that were found after the copepodid stages had disappeared.

By early December 1952 a few females, stage V copepodids and nauplii had appeared, in mid-December stages I and II were dominant,

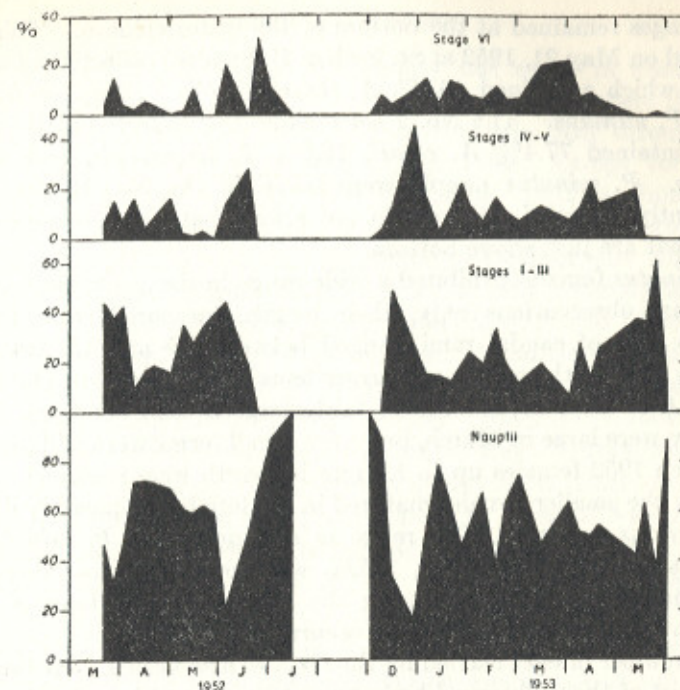

Figure 11. Relative percentages of nauplii and copepodid stages of *Pseudocalanus minutus*.

and by the end of the month all stages were present. From January to April 1953 spawning was continuous. The numbers of adults increased to approximately 350/m³ in late January and mid-February and reached maxima of over 1,000/m³ in mid-March. The first major burst of nauplii occurred in mid-January, when 2,000/m³ were recorded (see Fig. 11). During most of the period from February 10 to March 15 the numbers of nauplii remained around 3,000. Nauplii also appeared in comparable numbers in early and late April. Thereafter the total numbers of all stages decreased abruptly. During the latter half of May only stages I to III and nauplii were present. Possibly these developed into a last generation of adults in June, as in 1952.

Appreciable numbers of stage VI *P. minutus* were found only from January to April. Later in the spring, disproportionately low numbers of adults were taken. Possibly, as the temperature rose the

older stages remained at the bottom of the water column. This was observed on May 21, 1952 at St. 5 when H. Sanders collected a bottom sample which contained 46.5% *A. clausi*, 38.4% *T. longicornis*, and 16.4% *P. minutus*. The No. 2 net oblique tow collected at the same time contained 77.4% *A. clausi*, 19.3% *T. longicornis*, and no *P. minutus*. *P. minutus* nauplii were taken in the No. 10 net haul. Apparently, the oblique tows do not always sample adequately the forms that are just above bottom.

P. minutus females exhibited a wide range in size. On the basis of occasional observations only, their length, measured from top of head to base of caudal rami, ranged between 1.0 and 1.8 mm. In January 1953 both smaller and larger females were present, the range being 1.0 to 1.7 mm; most were fairly large in mid-February. The majority were large in March, but a few small forms were still present. In March 1952 females up to 1.8 mm in length were recorded. Presumably the smaller females matured in the late fall or possibly during the previous summer. The range in size noted for *P. minutus* in Block Island Sound (Deevey, 1952a) was not as extreme; there the small individuals matured during the summer, larger females were found in January, and the largest occurred in March.

The number of eggs carried by the females also varied. In January 1953 most of those observed had one or two eggs, although a few had up to 10 eggs. In mid-February, females approximately 1.7 mm in length carried up to 10 eggs, in March up to 16 eggs. In April occasional specimens carried large egg sacs, others only one egg. Evidently conditions in Long Island Sound were optimal for *P. minutus* during March. Marshall and Orr (1952) found that egg production in *Calanus* depends primarily on the quantity of food available, and Marshall (1949) noted a similar relationship between food and egg production in *Pseudocalanus*; in the latter, however, the largest females produced the greatest number of eggs. Since total numbers of diatoms were high in March (see S. A. M. Conover in this volume), it is not surprising that the largest *P. minutus* and also the greatest number of eggs per eggsac were observed at this time.

P. minutus was more numerous in Block Island Sound (Deevey, 1952a), where it was the dominant winter to spring species and where it occurred throughout the year, although in minimal numbers from September to December. Even though it is capable of maintaining itself in Long Island Sound at lowered salinities and over a wide range of temperature, it is primarily a neritic species.

OTHER COPEPODS

A few other species occurred regularly but never in abundance. *Centropages hamatus* (Lilljeborg) was found in small numbers throughout the spring and was most numerous from late May through July 1952. Fewer numbers were recorded in 1953. Except for April, it was present every month from November 1952 to June 1953. *Tortanus discaudatus* (Thompson and Scott) was most numerous from May to July 1952, but it was found also in October and November 1952 and in January, April, May, and June 1953. *Pseudodiaptomus coronatus* Williams occurred regularly from June 1952 to March 1953, in largest numbers from July to November. *Labidocera aestiva* Wheeler was noted from the end of June to the end of December 1952; it was most abundant in early September. Since these four species have a fairly wide salinity tolerance, one or more factors other than the lower salinity must have been responsible for their occurrence in limited numbers. In this general area, *C. hamatus* was observed in relative abundance only in the surface waters of Block Island Sound (Deevey, 1952b). The other species may prefer more specialized environments. *P. coronatus*, for example, was obtained in numbers on only one occasion, at St. 217 on September 30, 1952 when it constituted 83.5% of a night tow; this station was at one of the eastern entrances to the Sound in an area of rapid currents. Also it should be noted that, compared with the dominant species, except for *Pseudocalanus minutus*, these four species are relatively large. *T. discaudatus* is a carnivore, but the others are not, and possibly the particular forms that they prefer for food are not abundant in the Sound.

Harpacticoids were recorded every month except June 1952. Only three species were identified; *Alteutha depressa* Baird was found in January and April, but *Clytemnestra rostrata* (Brady) and *Microsetella norvegica* (Boeck) were noted only in April 1953. These species probably entered from Block Island Sound. An unidentified cyclopoid copepod occurred in April, May, June and August 1952 and in April and May 1953. *Eurytemora* sp., a brackish water calanoid, was found only in November 1952.

The several remaining species of copepods noted were stray specimens of neritic forms which were observed occasionally but which could not survive for any length of time in the Sound: *Centropages typicus* Krøyer, *Calanus finmarchicus* (Gunner), *Paracalanus parvus* (Claus), *Metridia lucens* Boeck, and *Candacia armata* (Boeck). Table

IV gives the records of their occurrence. These strays from neritic waters must have been carried into the Sound in the more saline bottom waters that enter from Block Island Sound.

CLADOCERA

Three species of Cladocera, *Evadne nordmanni* Loven, *Podon polyphemoides* (Leuckart), and *Penilia avirostris* Dana, were abundant seasonally, but several others were also present. *Podon leuckarti* Sars occurred at St. 2 in June 1952 and *P. intermedius* Lilljeborg was found at Sts. 2 and 5 in late June and July and at Sts. 219 and 220 in October 1952. *Bosmina* sp. was recorded in June, September and October 1952 and in January, May and June 1953. *Daphnia* sp. was noted at St. 2 on June 1, 1953, and *Daphnia ephippia* were observed at Sts. 1 and 2 in November 1952. The highest percentages of Cladocera were found at Sts. 1 and 5, but in all instances the total numbers of the several important species were highest at St. 1.

Fig. 12 shows the mean total numbers of *P. polyphemoides* collected in the No. 2 and No. 10 net samples in 1952. Only a small proportion of the *P. polyphemoides* population was retained by the No. 2 net. *P. polyphemoides* appeared at St. 1 during the latter part of May but not at the other stations until June. Two maxima were found in the No. 10 net hauls from Sts. 1 and 2, but by far the greater numbers occurred at St. 1, where approximately 15,000/m³ were recorded on June 19 and nearly 30,000/m³ on July 8. At St. 8 the highest numbers obtained were 1,000/m³ in June; at St. 5 it was not numerous until July. Two maxima of approximately 1,000/m³ were found in the No. 2 net samples, and it is of interest to note that the highest numbers of the larger specimens occurred in each case a week before the maxima recorded for the No. 10 net hauls. Although it has a wide salinity tolerance, *P. polyphemoides* apparently prefers waters of lower salinity. It was the only species of Cladocera observed in Tisbury Great Pond (Deevey, 1948), where it was found to be extremely euryhaline and moderately eurythermal, but it occurred in smaller numbers there than at St. 1. It was not found in Block Island Sound (Deevey, 1952a, 1952b). There this genus was represented by *P. leuckarti* and *P. intermedius*, species which did not occur in any quantity in Long Island Sound. *P. polyphemoides* was previously reported from Long Island Sound by Fish (1925).

Evadne nordmanni occurred from April to August 1952, with greatest

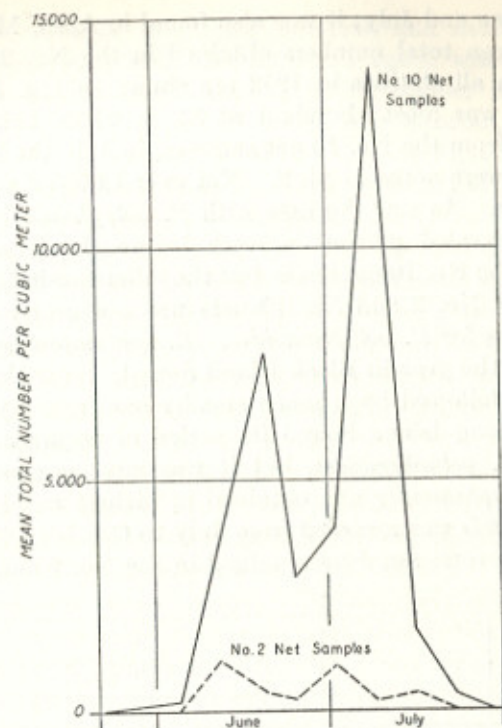

Figure 12. Mean total numbers of *Podon polyphemoides* per cubic meter obtained in the No. 10 and No. 2 net hauls in 1952.

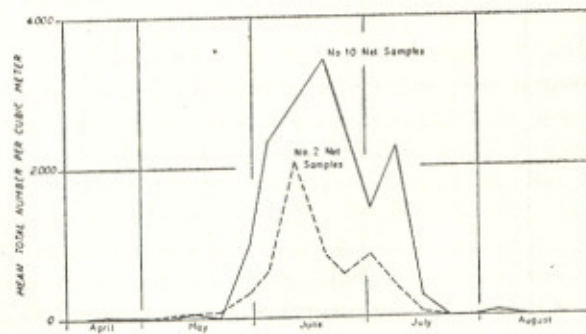

Figure 13. Mean total numbers of *Evadne nordmanni* per cubic meter taken in the No. 2 and No. 10 net hauls in 1952.

numbers in June and July; it was also found in April, May and June 1953. The mean total numbers obtained in the No. 2 and No. 10 net hauls from all stations in 1952 are shown in Fig. 13. In June *E. nordmanni* was most abundant at St. 1, where nearly 6,000/m³ were recorded from the No. 10 net samples; in July the highest numbers, 3,500/m³ were noted at St. 2. Not over 1,000/m³ were obtained at Sts. 5 and 8. As was the case with *P. polyphemoides*, the No. 2 net samples revealed maxima a week before the largest numbers were found in the No. 10 net hauls, but the difference in total numbers retained by the No. 2 and No. 10 nets was not nearly as great for *E. nordmanni* as for *P. polyphemoides*. *E. nordmanni* occurred for a greater part of the year in Block Island Sound, where the early June maximum was followed by a much smaller one from late August to October. In Long Island Sound its period of occurrence coincided with that of *P. polyphemoides*, but it was most numerous in June whereas *P. polyphemoides* was obtained in highest numbers in July.

Penilia avirostris was recorded from July to October 1952. Fig. 14 shows the mean total numbers obtained in the No. 2 and No. 10 net

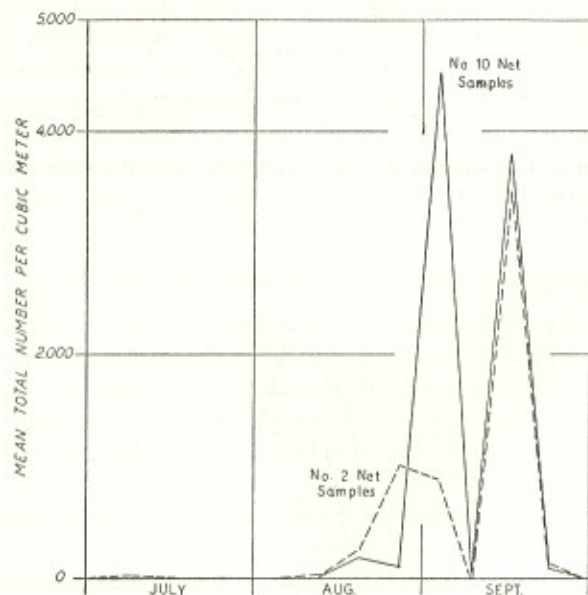

Figure 14. Mean total numbers of *Penilia avirostris* per cubic meter obtained in the No. 2 and No. 10 samples in 1952.

hauls. As in the case of *P. polyphemoides* and *Evadne nordmanni*, *P. avirostris* was most abundant at Sts. 1 and 2 where two maxima occurred, the first at the beginning of September and the second only two weeks later. At St. 2 the highest number, 6,000/m³, was recorded in early September, at which time 7,500/m³ were noted at St. 1; in mid-September nearly 11,000/m³ were found at St. 1. Only one maximum was recorded at Sts. 5 and 8; at St. 8 1,700/m³ were noted in late August, but at St. 5 it was not numerous until mid-September (4,000/m³). The No. 2 net samples showed a small early maximum in late August, but in mid-September almost as many were retained by the No. 2 as by the No. 10 net. In Block Island Sound in 1949 *P. avirostris* was also found from August to October. This species has not hitherto been considered a regular member of the zooplankton communities of the coastal waters of the northeastern Atlantic coast of the United States. Although it was noted seasonally in Block Island Sound (Deevey, 1952a, 1952b), it appeared together with the influx of warm water species in late summer and early fall. *P. avirostris* itself is primarily a warm water species. However, it may have extended its range recently. It was first observed at St. 1 in July, earlier than its usual time of appearance in Block Island Sound; it was also most abundant at St. 1. This may mean that it has now become acclimated to these waters and is an indigenous member of the plankton fauna. So far as is known, all of the other records for this species in these latitudes are from neritic waters. Its occurrence in waters of lower salinity may not have been reported previously.

THE LARVAE OF BOTTOM INVERTEBRATES

The periods of occurrence of the various larvae of bottom invertebrates are given in Table IV. Only lamellibranch veligers, gastropod veligers and polychaete larvae were obtained in numbers, but echinoderm larvae and barnacle larvae were fairly numerous seasonally. The total numbers of bottom larvae taken in the No. 10 net hauls at St. 2 are shown in Fig. 3.

Lamellibranch veligers constituted by far the greater part of the total numbers of bottom larvae recorded during the year. Fig. 15 presents the mean numbers taken in the No. 10 net samples. Maximal numbers were found from late May to mid-July 1952; a smaller maximum occurred in September. The highest number,

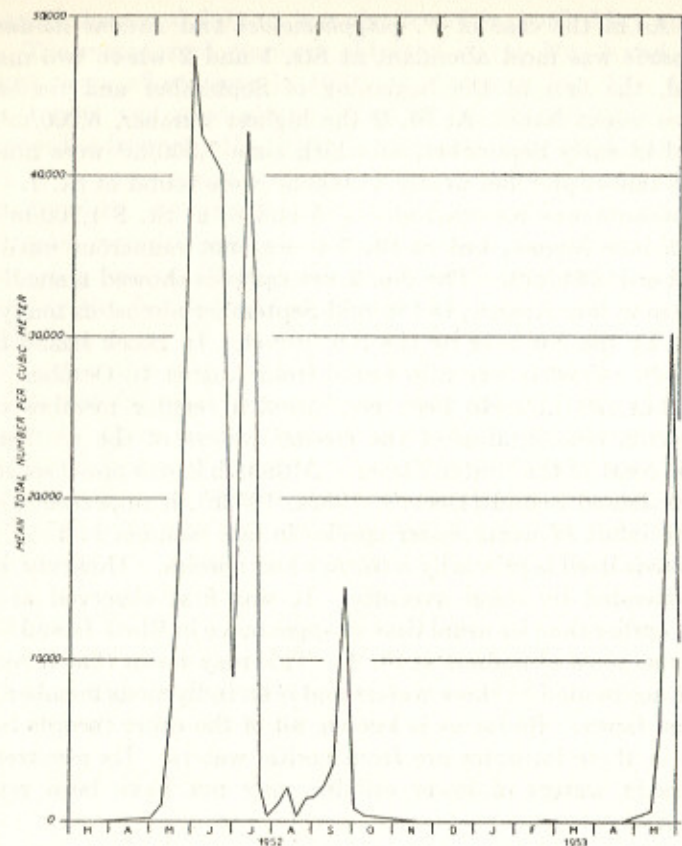

Figure 15. Mean total numbers of lamellibranch veligers per cubic meter taken in the No. 10 net samples from March 1952 to June 1, 1953.

81,300/m³, was noted at St. 2 on July 8. Few were present during the fall and none were recorded in December and January. In 1953, small numbers were found from late February to mid-May, when the numbers increased abruptly once more, although they had declined on June 1.

Gastropod veligers were numerous only during the summer of 1952, although small numbers or occasional specimens were recorded from April 1952 to January 1953 (see Table IV). They were not present during late winter and spring 1953. The mean numbers taken in the No. 10 net samples are shown in Fig. 16 together with those of the

polychaete larvae. The numbers increased in June, were maximal during July and August, and decreased by October. Relatively few gastropod veligers were obtained in the No. 2 net samples.

The only other molluscan larvae noted were occasional specimens of squid larvae at the offshore stations in August, September and October 1952.

Polychaete larvae were present every month from March 1952 to June 1953, but they were abundant only during July and to a lesser extent in August. The mean numbers from the No. 10 net samples

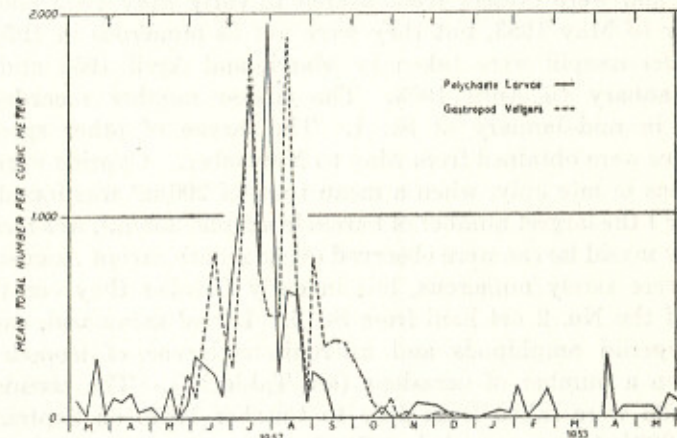

Figure 16. Mean total numbers per cubic meter of gastropod veligers and polychaete larvae obtained in the No. 10 net samples.

are presented in Fig. 16. Few were observed during late fall, small numbers were found during winter and spring, and large numbers occurred only in July.

Autolytus sp. was noted on a number of occasions (see Table IV), but *Tomopteris* sp. was found only in March 1953 at the offshore stations. *Tomopteris* is a pelagic polychaete, whereas *Autolytus* commonly appears in the plankton only at certain stages of its life history.

The cyphonautes larvae of Bryozoa were more numerous in Block Island Sound than in Long Island Sound, where a few were observed in the spring and from late summer to early fall (see Table IV). The highest numbers were found in samples collected on cruises to the eastern part of the Sound. Approximately 125/m³ were recorded

from the No. 2 net samples obtained on the June 1952 cruise and 165/m³ from No. 10 net samples collected on October 1, 1952.

Echinoderm larvae were present in appreciable numbers only in July and August 1952, although they also occurred in June and September. Highest numbers were found at St. 1, where 800/m³ were recorded on July 15 and 1,230/m³ on July 22. In August fewer than 200/m³ were noted.

Quite a variety of crustacean larvae was found (see Table IV). *Balanus balanoides* cyprids occurred in greater numbers than the nauplii and were present from March to early May 1952 and from January to May 1953, but they were not as numerous in 1953. *B. balanoides* nauplii were taken in March and April 1952 and from early January to April 1953. The largest number recorded was 500/m³ in mid-January at St. 1. The larvae of other species of barnacles were obtained from May to November. Cyprids were most numerous in late July, when a mean total of 200/m³ was found. On October 1 the largest number of barnacle nauplii, 355/m³, was recorded.

A few mysid larvae were observed every month except August 1952. They were rarely numerous, but in early October they constituted 9.4% of the No. 2 net haul from St. 5. Larval gammarid, caprellid and hyperiid amphipods and microniscus larvae of isopods were noted on a number of occasions (see Table IV). The pseudozoeae of *Squilla* were taken from July to October 1952; on September 9 nearly 200/m³ were recorded at St. 2. Cumacea were obtained only during the April 1953 cruise to the eastern end of the Sound.

Larval *Crago septemspinus* was found at most of the stations fairly continuously but in small numbers from mid-April to December 1952 and from April to June 1953. *Hippolyte* larvae were noted occasionally in spring and summer, whereas *Upogebia* and *Eupagurus* larvae were taken frequently during the summer and fall months (see Table IV). Porcellanid larvae were found only in the eastern part of the Sound in October 1952.

The remaining crustacean larvae belong to the Brachyura. The zoeae of *Libinia* sp., *Neopanope texana sayi*, *Pinnixa* sp., and *Calinectes sapidus* occurred continuously during the summer and early fall. *Cancer irroratus* zoeae were taken also in late spring (see Table IV), but the zoeae of *Pelid mutica* and *Pinnotheres maculatus* were observed only in the early fall. Zoeae were most numerous in August, the highest number recorded being 410/m³ at St. 8 on August 12.

Megalops larvae were found from August to October and young specimens of *Pinnotheres* sp. were taken in the zooplankton hauls in August and October.

OTHER FORMS

Of the remaining groups of organisms, the tunicates and rotifers (see Fig. 17) appeared seasonally in relatively large numbers. *Oikopleura dioica* Fol was the only tunicate that occurred in abundance, but *Fritillaria* sp. was found at St. 318 in the eastern part of the Sound in April 1953. *O. dioica* was present at most of the regular stations

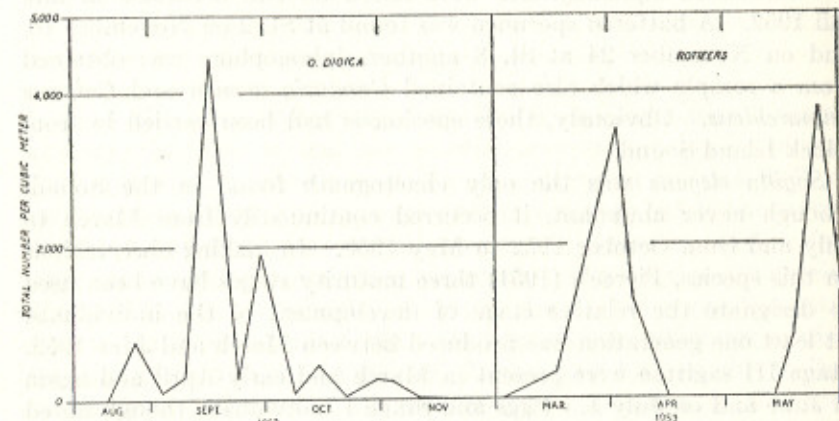

Figure 17. Mean total numbers per cubic meter of *Oikopleura dioica* and rotifers taken in the No. 10 net hauls.

from mid-August to mid-November 1952, with maximal numbers in mid-September, when about 5,500/m³ were recorded at St. 2, 4,800/m³ at St. 1, and 3,000/m³ at St. 5. At St. 8 maximal numbers of about 1,300/m³ were found in late August. In Block Island Sound this species occurred from July to September in comparable numbers (Deevey, 1952a).

Rotifers were found in March, April, May, and November 1952 and from February to June 1953. They were present in minimal numbers in 1952, but in 1953 they were fairly abundant in early April and late May (see Fig. 17). The highest number recorded was 7,000/m³ at St. 2 in early April. Only during the latter part of May were they observed at all of the regular stations.

Hydromedusae were found in small numbers throughout the

period studied. They were somewhat more numerous in April of each year, the highest number being 535/m² at St. 8 in 1952. As yet all of the species have not been identified. *Hybocodon prolifer* occurred in March and April 1952 and from January to April 1953, *Rathkea octopunctata* from March to May 1952 and from January to April 1953. *Sarsia mirabilis* was found in April, *Stomatoca dinema* in November, and *Nemopsis bachei* in December 1952. Several other species were also present. Actinuli (see Table IV) were recorded in the fall and spring.

Unidentified siphonophores were noted on two occasions in late fall 1952. A battered specimen was found at St. 2 on November 10, and on November 24 at St. 8 another siphonophore was obtained from a sample which also contained *Candacia armata* and *Calanus finmarchicus*. Obviously, these specimens had been carried in from Block Island Sound.

Sagitta elegans was the only chaetognath found in the Sound. Though never abundant, it occurred continuously from March to July and from October 1952 to May 1953. In making observations on this species, Pierce's (1951) three maturity stages have been used to designate the relative stage of development of the individuals. At least one generation was produced between March and June 1952. Stage III sagittae were present in March and early April and again in June and on July 1. Eggs and Stage I individuals, though noted every month from March to July, were more numerous in March and early April and in June and July. The sagittae disappeared the latter part of July.

Between fall 1952 and late May 1953 probably three generations were produced, but reproduction must have been fairly continuous during winter and spring, since eggs were present from December to late May. A few stage I individuals appeared in October, and these were followed by stage II sagittae in November and December 1952. Stage III individuals were present in January, March to early April, and mid-May 1953. Probably the sagittae which matured in January produced the generation that matured in March and early April, and these spawned the individuals that were beginning to mature by mid-May. The available data give no clue to the origin of the sagittae that appeared in the fall. In Block Island Sound, too, *Sagitta elegans* was not found in the zooplankton tows during late summer and early fall (Deevey, 1952b). Also, it is not known whether

Sagitta is indigenous to Long Island Sound or whether it is continually brought in from Block Island Sound in the deeper, more saline waters.

The other organisms taken in the zooplankton tows were nematodes and fish eggs and larvae. Nematodes were recorded only in September and October 1952 and in April and May 1953. Fish eggs and larvae were never found in numbers in the hauls, although fish larvae were noted every month from March 1952 to May 1953 and fish eggs were absent from the samples only from November through February. These forms have been studied in detail by Wheatland, whose report is given in an accompanying paper.

DISCUSSION

All of the zooplankton organisms living in Long Island Sound are euryhaline species that are adapted to waters of lower salinity. The copepods are the dominant group, comprising at least 80% of the population during the greater part of the year, while the larvae of bottom invertebrates, several species of Cladocera, and a few other forms are fairly abundant seasonally. Although a few species of copepods are exceedingly numerous during the year, the total number of species is limited, since the neritic forms which are carried into Long Island Sound from Block Island Sound are unable to live at the lower salinities. The zooplankton population is therefore more or less self contained. The dominant copepods are small species. For reasons not apparent at present, several larger copepods which might be expected to occur were found only in limited numbers, at least at the stations studied. The important species are *Acartia clausi*, *A. tonsa*, *Temora longicornis*, *Paracalanus crassirostris*, and *Oithona* spp.

Whereas most of the neritic species of the neighboring waters are barred from Long Island Sound by the lower salinities, nearly all of the forms found in abundance in the Sound are fairly numerous in Block Island Sound. *Acartia tonsa*, *Temora longicornis*, *Paracalanus crassirostris* and *Oithona* spp. are relatively abundant and contribute appreciably to the total numbers of the zooplankton population of Block Island Sound. Only *Acartia clausi*, the species most successfully adapted to living in Long Island Sound, is evidently incapable of maintaining itself in numbers in Block Island Sound. On the other hand, *Pseudocalanus minutus* is the only primarily

neritic copepod that is able to survive and reproduce successfully in Long Island Sound.

Of the other members of the plankton fauna, two of the important species of Cladocera, *Penilia avirostris* and *Evadne nordmanni*, occur in both Long Island Sound and Block Island Sound, although they were more numerous in the former. *Podon polyphemoides*, numerically the most abundant cladoceran in Long Island Sound, has not been recorded from Block Island Sound, where it is replaced by two other species of *Podon*. The higher salinities should not have barred *P. polyphemoides*, since, according to Baker (1938), it has a wide salinity tolerance and occurred throughout the year in Monterey Bay where salinities are higher than those of Block Island Sound. The two species of *Podon* found in Block Island Sound were not numerous in Long Island Sound.

Of all the groups and species of zooplankton organisms observed in Block Island Sound, few can tolerate the lower salinities of Long Island Sound. *Pseudocalanus minutus* and *Sagitta elegans* are the two forms living in Long Island Sound whose stock may be continually augmented by repeated incursions from Block Island Sound. Possibly *Oikopleura dioica* should be included with these species, since it occurs in comparable numbers in both Sounds. Presumably the hydromedusae, found equally in the two areas, are not affected by changes in salinity. Conversely, the majority of species which are abundant in Long Island Sound may be carried out in the less saline surface waters, thus increasing the variety of plankton in Block Island Sound.

Zooplankton displacement volumes have been found to be of the same order of magnitude throughout the coastal waters of the northeastern United States (Riley, *et al.*, 1949). A similar range of volumes has been noted in some European waters also (Wiborg, 1954). Over the continental shelf from Cape Cod to Chesapeake Bay, Bigelow and Sears (1939) found volumes of 0.4 to 0.8 cc/m³, while the zooplankton of Georges Bank (Riley and Bumpus, 1946) yielded a mean of 0.72 cc/m³. Redfield's (1941) data gave mean volumes varying between 0.3 and 0.53 cc/m³ for the different sectors of the Gulf of Maine. For Block Island Sound (Deevey, 1952a) the mean volumes obtained were 0.68 cc/m³ for the No. 10 net samples and 0.21 cc/m³ for the No. 2 net hauls. The mean concentrations recorded for 1952 to 1954 for Long Island Sound were 0.95 cc/m³ for the No. 10 net tows

and 0.29 cc/m³ from the No. 2 net samples. Apparently, in both Sounds the No. 2 net sampled only about a third of the total population. If the figure of 0.95 cc/m³ is accepted as representative of the quantity of zooplankton in Long Island Sound, it appears that these waters produce a slightly greater volume than the neritic areas investigated.

However, the Sound is a relatively shallow body of water, the depths varying from approximately 9 to 27 m at the stations studied, while the mean depths of Georges Bank and Block Island Sound are 65 and 30 m respectively. When estimates of the mean volumes beneath a square meter of sea surface are made, it is seen that at best the total crop produced in Long Island Sound is probably no greater than that of Block Island Sound. This is illustrated in Fig. 18, which compares the mean monthly volumes, in cc/m² of sea surface, recorded

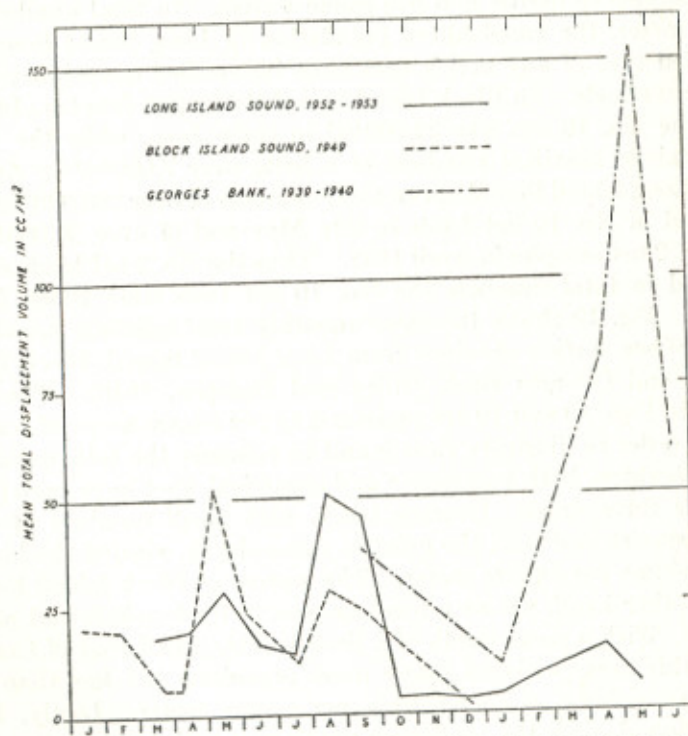

Figure 18. Mean monthly zooplankton displacement volumes, in cc/m² of sea surface, recorded from Long Island Sound, Block Island Sound and Georges Bank.

from Georges Bank, Block Island Sound and Long Island Sound. Fig. 18 also shows that maximal volumes were found in late spring and late summer in both Sounds, while the Georges Bank volumes were highest in May. The mean volumes obtained for the No. 10 net zooplankton from the four stations in Long Island Sound (see Table III) ranged from 8.1 at St. 1 to 19.8 cc/m² at St. 2. The mean volume recorded for Block Island Sound was 20.4 cc/m² of sea surface, while the estimated mean for Georges Bank, 48 cc/m², is more than twice as large. Therefore, although Long Island Sound yielded a relatively high volume of zooplankton per cubic meter, the total crop produced did not exceed that of Block Island Sound and was not half as large as the mean volume per square meter of sea surface recorded for Georges Bank.

It is also of interest to compare the difference in total numbers of organisms in neritic and less saline waters. In total numbers per cubic meter, the zooplankton population of Long Island Sound far exceeded that of any neritic area thus far studied quantitatively by similar methods. In Block Island Sound the largest number obtained with the No. 10 net was 32,000/m³ in early June, while the No. 2 net retained maximal numbers of a little over 7,000/m³ in August. From Long Island Sound, mean total numbers of over 200,000/m³ were recorded in No. 10 net hauls in late May and of over 30,000/m³ in the No. 2 net samples in April 1952. Thus the No. 2 net hauls almost equalled in total numbers the No. 10 net tows from Block Island Sound. Fig. 19 shows the mean monthly total numbers per square meter of sea surface obtained from Long Island Sound, Block Island Sound, and Georges Bank (Riley and Bumpus, 1946). The data shown in Figs. 18 and 19 are presented as per square meter of sea surface in order to illustrate clearly and to compare the total quantities of zooplankton, both volumetric and numerical, that have been found in these three areas. Georges Bank, with small numbers of large neritic species and with the greatest mean depth, yielded the highest total volume per square meter. The waters of Block Island Sound, on the other hand, act as a meeting ground for brackish and neritic species. With a mean depth of a little less than half that of Georges Bank, this area produced many more organisms but less than half the mean volume of zooplankton per square meter. Lastly, Long Island Sound, with the shallowest depth and with a population consisting almost entirely of small species, yielded volumes which were

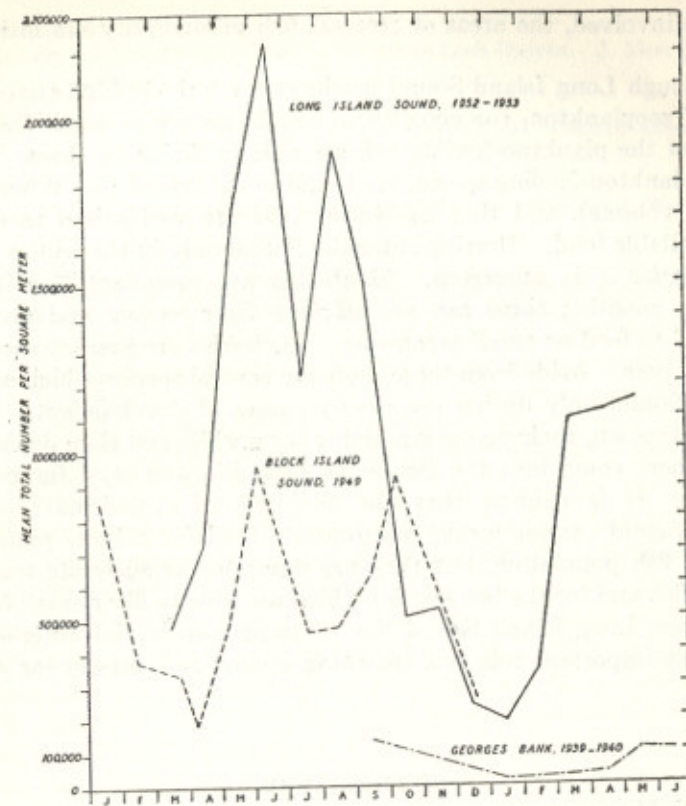

Figure 19. Mean monthly total numbers per square meter of sea surface recorded from Long Island Sound, Block Island Sound and Georges Bank.

comparable to those of Block Island Sound but produced at least twice as many organisms for the total water column. There is thus an extraordinary increase in total numbers of zooplankton in passing from offshore neritic areas to inshore neritic and then to more enclosed, less saline waters. Accompanying this there is evidently a tremendous decrease in the mean size of individuals, since the mean displacement volumes per cubic meter do not vary widely. Less saline waters favor the development of a zooplankton population composed chiefly of small organisms, if only by excluding the larger neritic species. This is undoubtedly of considerable import to the higher forms in the food chain, and it helps to explain why, aside from the other

factors involved, the areas of greatest fish productivity are in neritic waters.

Although Long Island Sound produces a relatively high concentration of zooplankton, the constituent organisms are so small that not many of the plankton-feeding fish are able to thrive on them. Only a few plankton-feeding species are found in the Sound (see Wheatland in this volume), and they are forms that are well suited to utilize the available food. Herring enter the Sound only in the winter when *Pseudocalanus* is numerous. Menhaden are abundant during the summer months; these fish are efficient filter feeders and are well adapted to feed on small organisms. Anchovies are present throughout the year. Aside from these there are several species which appear in the Sound only during their early stages of development. Some enter to spawn, their young remaining for a while and then departing, and others come into the Sound as juveniles and stay for several months. It is evident that the zooplankton organisms of Long Island Sound cannot furnish appropriate food for a large plankton-feeding fish population, but they are nevertheless adequate food for young fish and for the few species which are able to filter small forms. Therefore, Long Island Sound has no large commercial fisheries but serves an important role as a spawning ground and nursery for young fish.

BIBLIOGRAPHY

- BAKER, H. M.
1938. Studies on the Cladocera of Monterey Bay. Proc. Calif. Acad. Sci., (4) 23: 311-365.
- BIGELOW, H. B. AND MARY SEARS
1939. Studies of the waters of the Continental Shelf, Cape Cod to Chesapeake Bay. III. A volumetric study of the zooplankton. Mem. Harv. Mus. comp. Zool., 54 (4): 183-378.
- DEEVEY, G. B.
1948. The zooplankton of Tisbury Great Pond. Bull. Bingham oceanogr. Coll., 12 (1): 1-44.
1952a. Quantity and composition of the zooplankton of Block Island Sound, 1949. Bull. Bingham oceanogr. Coll., 13 (3): 120-164.
1952b. A survey of the zooplankton of Block Island Sound, 1943 to 1946. Bull. Bingham oceanogr. Coll., 13 (3): 65-119.
- FISH, C. J.
1925. Seasonal distribution of the plankton of the Woods Hole region. Bull. U. S. Bur. Fish., 41: 91-179.

- MARSHALL, S. M.
1949. On the biology of the small copepods in Loch Striven. J. Mar. biol. Ass. U. K., N. S. 28: 45-122.
- MARSHALL, S. M. AND A. P. ORR
1952. On the biology of *Calanus finmarchicus*. VII. Factors affecting egg production. J. Mar. biol. Ass. U. K., N. S. 30: 527-547.
- PIERCE, E. L.
1951. The Chaetognatha of the west coast of Florida. Biol. Bull. Woods Hole, 100 (3): 206-228.
- REDFIELD, A. C.
1941. The effect of the circulation of water on the distribution of the calanoid community in the Gulf of Maine. Biol. Bull. Woods Hole, 80: 86-110.
- RILEY, G. A. AND D. F. BUMPUS
1946. Phytoplankton-zooplankton relationships on Georges Bank. J. Mar. Res., 6: 33-47.
- RILEY, G. A., HENRY STOMMEL AND D. F. BUMPUS
1949. Quantitative ecology of the plankton of the western North Atlantic. Bull. Bingham oceanogr. Coll., 12 (3): 1-169.
- WIBORG, K. F.
1954. Investigations on zooplankton in coastal and offshore waters of western and northwestern Norway with special reference to the copepods. Fiskeri-direktoratets Skr., 11 (1): 1-246.

OCEANOGRAPHY OF LONG ISLAND
SOUND, 1952-1954

VI. BIOLOGY OF ACARTIA CLAUSI AND A. TONSA¹

By

ROBERT J. CONOVER

Department of Zoology
and
Bingham Oceanographic Laboratory²

TABLE OF CONTENTS

ABSTRACT.....	157
INTRODUCTION.....	158
ACKNOWLEDGMENTS.....	159
COMPARATIVE DEVELOPMENT OF <i>A. CLAUSI</i> AND <i>A. TONSA</i>	160
<i>Methods</i>	160
<i>Naupliar Stages</i>	161
<i>Early Copepodid Stages</i>	166
<i>Later Stages</i>	166
SEASONAL DISTRIBUTION OF <i>A. CLAUSI</i> AND <i>A. TONSA</i> BASED ON PRESERVED MATERIAL.....	167
<i>Annual Variation in Total Numbers of Young and Adults</i>	167
<i>Seasonal Distribution of Adults</i>	168
<i>Distribution of Different Stages during Transition Periods</i>	171
<i>Number of Generations</i>	175
<i>Seasonal Variation in Size</i>	177
COMPARATIVE PHYSIOLOGY.....	183
<i>Light Responses</i>	184
<i>Effect of Temperature on Light Responses</i>	185
<i>Vertical Distribution in the Sound</i>	187
<i>Response of A. clausi to an Experimental Thermocline</i>	190
<i>Response to Colored Light</i>	193

¹ This paper represents the major portion of a dissertation presented to the Faculty of the Graduate School of Yale University in candidacy for the degree of Doctor of Philosophy.

² Present address: Narragansett Marine Laboratory, University of Rhode Island, Kingston, R. I.

Oxygen Consumption by <i>clausi</i> and <i>tonsa</i>	193
<i>Methods</i>	194
<i>Pilot Experiments</i>	196
<i>Effect of Light on Respiration</i>	197
<i>Effect of Temperature on Respiration</i>	199
<i>Seasonal Adaptation</i>	201
<i>Oxygen Consumption and Reproduction</i>	202
<i>Sexual Differences in Oxygen Consumption</i>	204
<i>Effect of Laboratory Conditions</i>	204
Relationship between Copepods and Available Food.....	206
<i>Methods</i>	207
<i>Effect of Cell Concentrations on Grazing</i>	210
<i>Effect of Copepod Waste Products on the Growth of Phytoplankton</i>	211
<i>Effect of Culture Age on Grazing Rates</i>	211
<i>Light and Grazing Rates</i>	212
<i>Sexual Differences in Grazing Rates</i>	213
<i>Effect of Temperature on Grazing</i>	213
<i>Question of Selective Feeding</i>	218
GENERAL DISCUSSION.....	220
Seasonal Distribution of the <i>Acartia</i> in Other Areas.....	224
Daily Zooplankton Production in the Sound.....	227
REFERENCES CITED.....	229

ABSTRACT

Descriptive data have been supplemented with comparative laboratory studies to determine as precisely as possible the effect of environment on *Acartia clausi* and *A. tonsa*. Developmental stages are described and the characters used to distinguish between them are discussed.

The Sound appears to be a marginal area for both species. *A. clausi* is dominant in winter and spring and *A. tonsa* is an important constituent of the zooplankton in summer and fall, but twice each year both species can be taken in the same plankton tow. During most of the year, males of both species are less abundant than females. Probably the males and certainly the developmental stages are affected by changes in the environment before the females. At least four generations of *clausi* and probably four generations of *tonsa* are produced each year. Whereas *tonsa* develops from egg to adult in three to four weeks during summer, *clausi* requires over a month for comparable development during the cooler months. For both species, the adult life is a month or less during much of the year, but in winter it is prolonged. Both species attain greatest size in winter and are smallest in summer.

Laboratory experiments demonstrate that light controls vertical migration but does not affect respiratory or grazing rates. Temperature was found to have a profound effect on metabolism and activity. Vertical migrations of *tonsa* are retarded by low temperatures, and a thermocline can limit the vertical migration of *clausi* when surface waters have warmed to a critical level (16 to 18° C). At low temperatures, *clausi* is more active and has a higher respiratory rate than *tonsa*.

Evidence for seasonal adjustment of metabolism, particularly for *clausi*, was found. The amount of food available and perhaps the reproductive state of the animals can also influence respiration. Temperature, the kind and amount of food, and the physiological state of the food culture affect feeding rates. Food selection has been demonstrated for both species; adult *clausi* and *tonsa* may have different food preferences in summer.

Respiratory and filtering rates were used to compare the relative efficiencies of each species under different temperature conditions. Adult *clausi* appears to be more successful in laboratory experiments under both winter and summer temperature conditions, but the total amount of food available in the natural environment, as indicated by chlorophyll analyses, appears to be sufficient to support a large population of either species in summer. However, grazing was relatively inefficient when the food organisms consisted of naked flagellates and other nanoplankton. These organisms were abundant in summer, so that food limitation was a possibility.

Evidence from Tisbury Great Pond suggests a rigid temperature control of seasonal distribution for these species. In Long Island Sound, temperature appears to control the dominance of *clausi* and *tonsa* in a more subtle manner. Classical competition theory is used to interpret the distribution of the Sound populations. During periods of coexistence, temperature keeps the ecological niches separated. However, twice a year the niches coincide, and competition, probably between the younger stages, eliminates the species less well adapted to prevailing conditions.

Data accumulated in this study have been used to interpret seasonal distribution of *Acartia* in other localities.

Daily zooplankton production of a population dominated by *Acartia* is estimated to be 16.6% under favorable conditions.

INTRODUCTION

Pelagic copepods constituted the major portion of the Long Island Sound zooplankton taken in routine hauls with the Clarke-Bumpus plankton sampler. Of the copepods, two species of *Acartia* predominated during most of the year. *A. clausi* was present throughout winter and spring and disappeared in July, while *A. tonsa* was most abundant from July to December or January, although some individuals lingered well into spring. Deevey (1948) observed a similar seasonal cycle for these species in Tisbury Great Pond, but there the period of existence for each was somewhat shorter and terminated more abruptly. Her data suggested a rigid temperature control; *clausi* apparently could not tolerate temperatures much over 20° C, and *tonsa* did not appear until temperatures reached 20°. However, in Long Island Sound the populations of *tonsa* survived the coldest months, only to disappear in spring after the water temperatures had begun to rise again.

If temperature is the factor that controls the seasonal distribution

of these species in the Sound, it may also control their geographical distribution. Both have been found in estuarine and coastal waters over much of the world, and occasionally they have been observed as part of the oceanic plankton. Although *clausi* has been reported from Lat. 50° S to 80° N and within 5° of the Equator in all major oceans, off the east coast of North America this species is more successful in the cooler waters (Sewell, 1948). Bigelow and Sears (1939) found that it was confined to coastal water south of Cape Cod; to the north, however, it might occur offshore as well. On the other hand, *tonsa* is largely restricted to a band of tropical, subtropical and warm temperate waters around the earth. While this species does penetrate the high latitudes in European waters, it is confined to warmer estuarine conditions. For instance, it is found in the Baltic and Gulf of Finland but not off the coast of Norway at comparable latitudes. On the east coast of the United States, Cape Cod may be a barrier to this form since, to the north, it has been found only in Plymouth Harbor (Wheeler, 1901); Bigelow (1926) did not report it from the Gulf of Maine.

Thus, Long Island Sound appears to be a marginal area for both *tonsa* and *clausi*, a region which is ideal for study of the environmental and biological interrelations that govern their distribution.

ACKNOWLEDGMENTS

I should like to thank Gordon A. Riley and other members of the Bingham Laboratory for their direction and help. Constructive criticism of this manuscript by Gordon A. Riley, Georgiana B. Deevey, John L. Brooks, and Daniel Merriman is greatly appreciated. Special thanks are extended to G. E. Hutchinson for his interest and helpful suggestions and to J. S. Nicholas and the Departments of Zoology and Botany for laboratory facilities. S. C. Shen, E. J. Boell, Morris Foster, and T. H. Waterman have given valuable assistance with physiological equipment and techniques, and Georgiana B. Deevey furnished some of the zooplankton estimates. James Roach and George Martin have been most helpful in acquiring and constructing apparatus. Jack Fu kindly assisted in the preparation of several figures.

The field work was carried out from the U. S. Fish and Wildlife Service vessel SHANG WHEELER, out of Milford, Connecticut. Thanks

are extended to Victor Loosanoff, director of the Milford Laboratory, and to Herman R. Glas, skipper of the SHANG WHEELER, for their cooperation.

Finally, this study would have been impossible without the understanding, encouragement and assistance of my wife, Shirley Conover.

COMPARATIVE DEVELOPMENT OF *A. CLAUSI* AND *A. TONSA*

In order to understand as clearly as possible the relationships between environment and zooplankton distribution in the Sound, it was necessary to obtain a detailed analysis of the seasonal variation in numbers of all the developmental stages. Grandori (1912) has described the copepodid stages of *Acartia clausi* and Oberg (1906) has given the only account of naupliar development within the genus. Since the descriptions by these authors were inadequate to separate the nauplii and younger copepodid stages of *clausi* and *tonsa*, it was essential at the beginning of this study to find reliable specific characters that could be employed for rapid identification of any developmental stage under low magnification.

Methods. Several previous workers have reared the younger stages of marine copepods from eggs obtained from captured females or from fresh-caught plankton tows. However, few if any marine calanoid copepods have been cultured successfully, and our attempts to establish laboratory cultures of *clausi* and *tonsa* met with similar failure. A few copepods were maintained in the laboratory for as long as six weeks, but no molting was observed, and when eggs were laid by apparently mature females, they failed to develop as far as the first naupliar stage. Alternatively, the developmental stages were described from preserved material.

With the aid of descriptions by Grandori and by Oberg, nauplii and copepodids of each species were sorted from the No. 10 net plankton taken during a period of the year when only one species of adult was present. These were grouped into the six naupliar and six copepodid stages and were permanently mounted in glycerine jelly. Each stage was examined for uniformity and then the same stages of each species were compared to determine if useful specific differences existed. Finally, groups of younger stages, taken from tows obtained during periods when the two species were likely to coexist, were examined

to determine whether the specific characters observed could be used to separate the juveniles.

Naupliar Stages. The nauplius of the *Acartia* is relatively unspecialized compared with nauplii of other calanoid genera. Because there are so few distinct morphological characteristics, distinguishing between the two species might have been difficult. While stages I and II showed no differences which could be employed for low magnification counts, at least one clear-cut difference could be used to separate stages III-VI.

Stage I, less than 0.1 mm long, showed little morphological resemblance to the adult (Figs. 1A, 1B). However, rudiments of the first antennae (a), second antennae (b), and mandibles (c) were present. After the first molt, the nauplius increased slightly in size while the second antennae and mandibles acquired certain specializations; to a taxonomist, the number and character of the short bristles on the ventral posterior region might be useful (Figs. 1C, 1D). In stage III, the primordia of the first maxillae (d) had appeared, but more important was the single pair of stout spines on the extreme posterior of what is destined to become the adult abdomen; on the *clausi* specimens (Fig. 1E) these spines were longer and stouter than those on the *tonsa* nauplii (Fig. 1F). By stage IV a second pair of stout spines had been added ventral to the first pair (Figs. 1G, 1H). The difference between the first pair of spines in stage IV was, if anything, more exaggerated than in stage III. In stage V (Figs. 2A, 2B), the rudiments of two additional thoracic appendages, the second maxillae (e) and maxillipeds (f), appeared, while the relationship between the posterior spines remained essentially unchanged. In stages IV and V, the difference in the dorsal, most posterior pair of spines was probably more pronounced in lateral view (Figs. 3A, 3B, 3C, 3D) than in either dorsal or ventral views. In stage VI, the first indication of swimming legs (g and h) became apparent, and the posterior spines were still distinguishing characteristics (Figs. 2C, 2D, 3E, 3F).

Although it was not possible to distinguish between *clausi* and *tonsa* before stage III, the inability to separate the first two stages did not appear to be an important handicap in the present investigation. Sverdrup, *et al.* (1942) gave 0.158 mm as the average aperture size for No. 10 bolting silk. The nets used in this investigation were not measured, but even allowing for a certain diminution of the

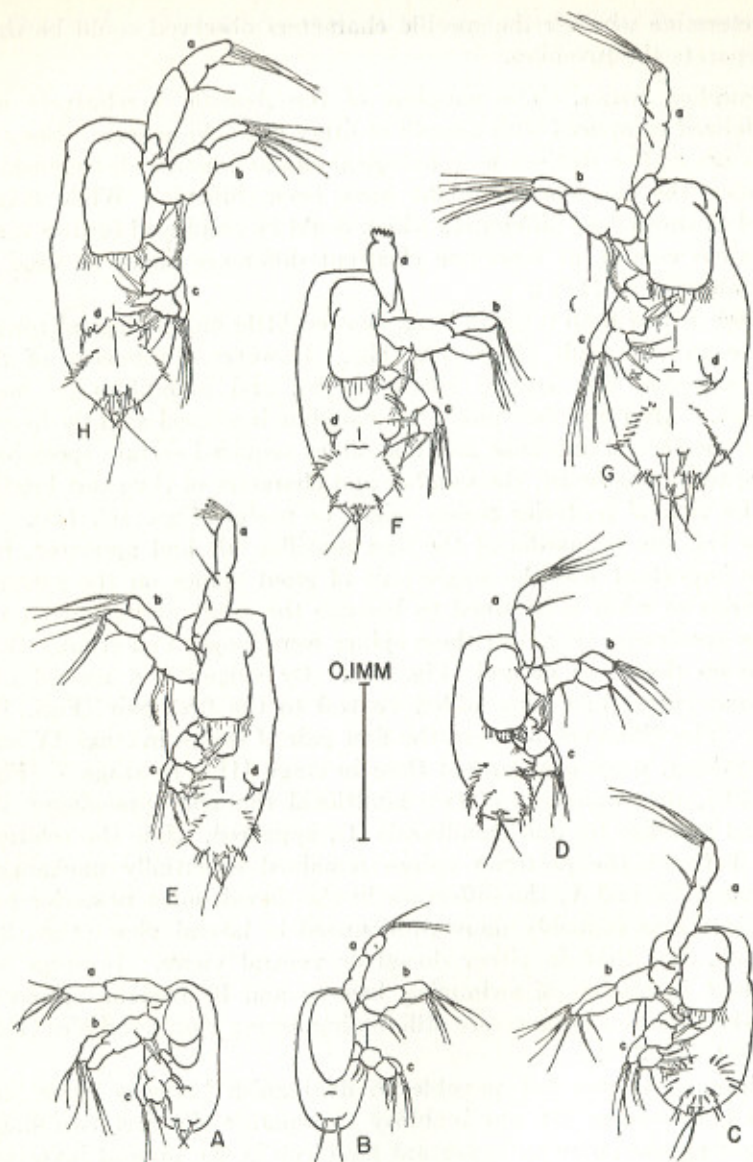

Figure 1. Naupliar stages I, II, III and IV. A, *clausi* stage I; B, *tonsa* stage I; C, *clausi* stage II; D, *tonsa* stage II; E, *clausi* stage III; F, *tonsa* stage III; G, *clausi* stage IV; H, *tonsa* stage IV. Key to naupliar appendages shown in Figs. 1-3. a, first antenna; b, second antenna; c, mandible; d, first maxilla; e, second maxilla; f, maxilliped; g, first swimming leg; h, second swimming leg.

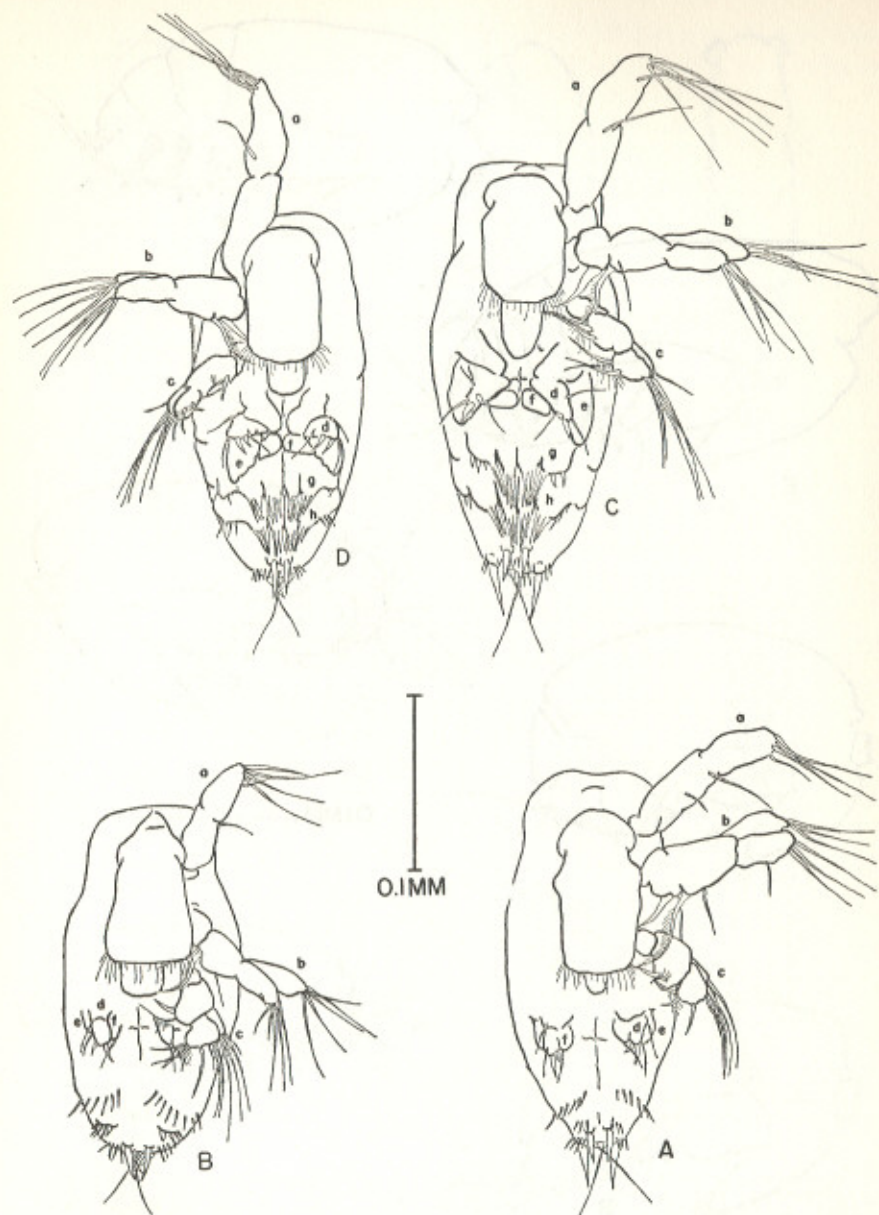

Figure 2. Naupliar stages V and VI. A, *clausi* stage V; B, *tonsa* stage V; C, *clausi* stage VI; D, *tonsa* stage VI. See Key in Fig. 1.

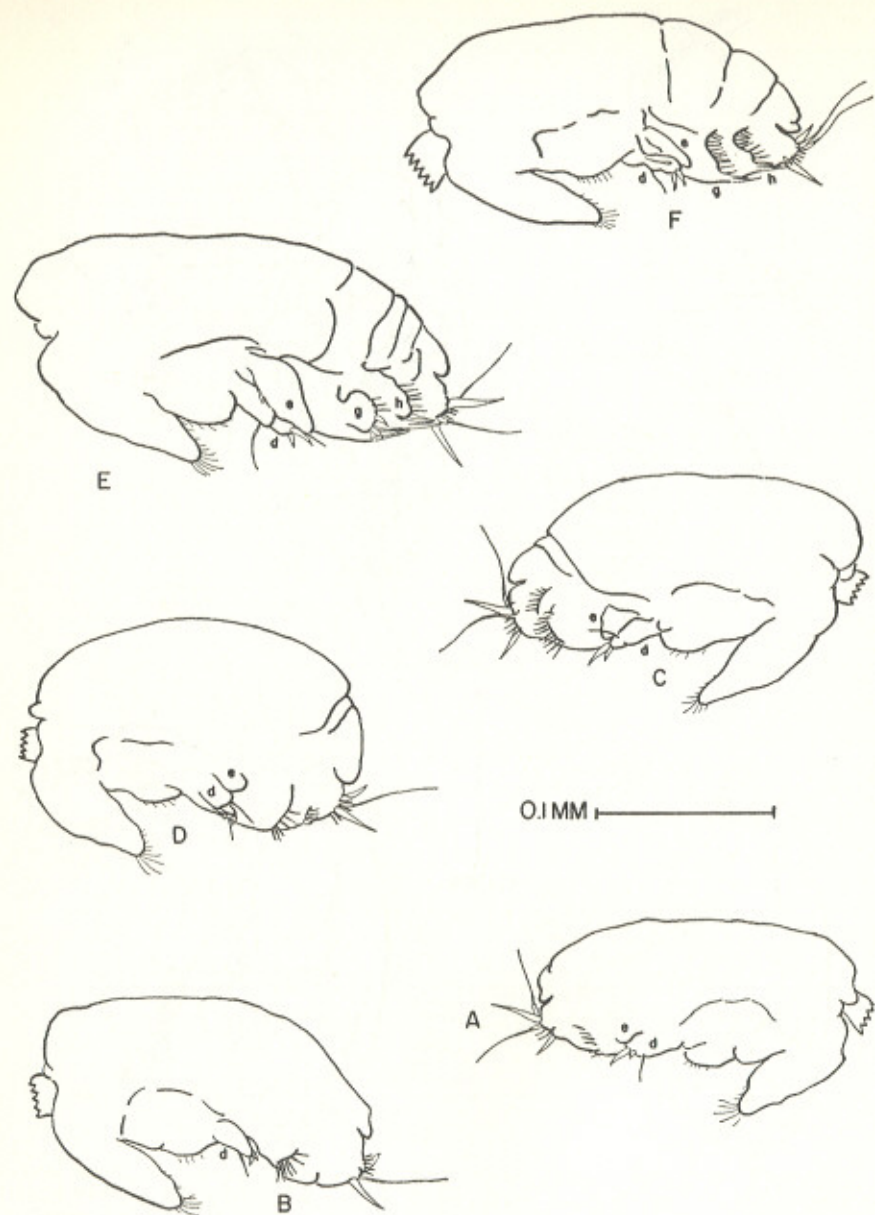

Figure 3. Naupliar stages IV, V and VI in side view. A, *clausi* stage IV; B, *tonsa* stage IV; C, *clausi* stage V; D, *tonsa* stage V; E, *clausi* stage VI; F, *tonsa* stage VI. See Key in Fig. 1.

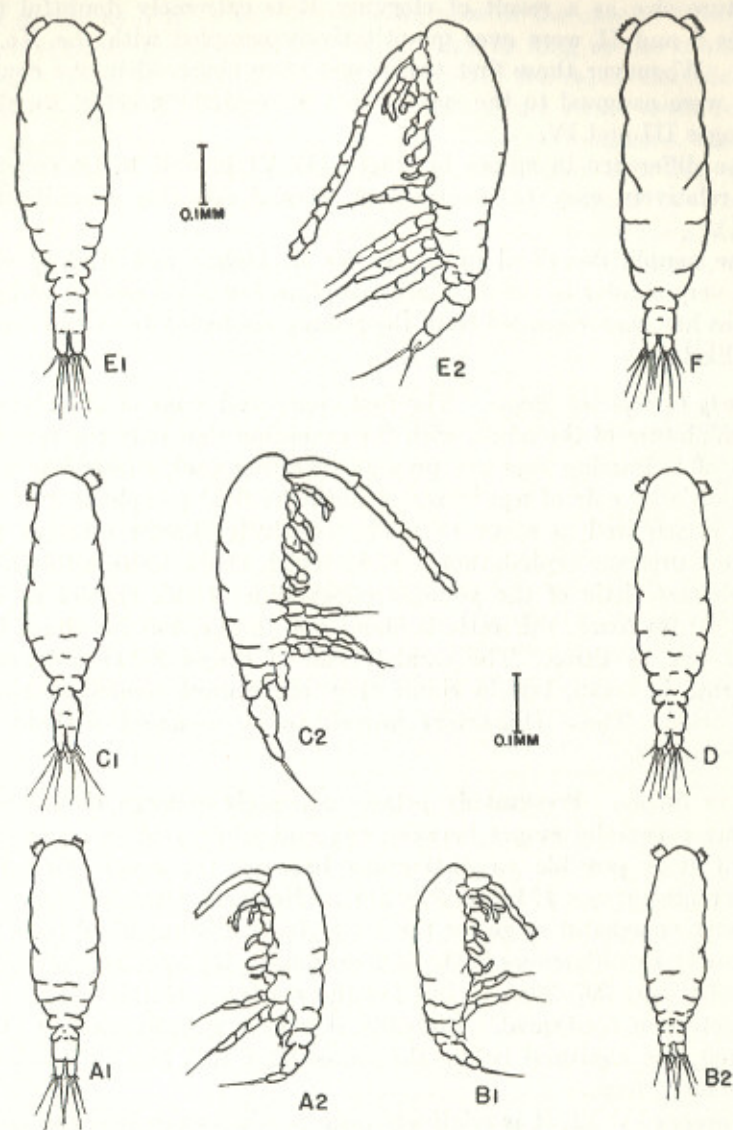

Figure 4. First three copepodid stages of *Acartia clausi* and *A. tonsa*. A1, dorsal view stage I *clausi*; A2, side view stage I *clausi*; B1, dorsal view stage I *tonsa*; B2, side view stage I *tonsa*; C1, dorsal view stage II *clausi*; C2, side view stage II *clausi*; D, dorsal view stage II *tonsa*; E1, dorsal view stage III *clausi*; E2, side view stage III *clausi*; F, dorsal view stage III *tonsa*.

aperture size as a result of clogging, it is extremely doubtful that stages I and II were ever quantitatively sampled with the No. 10 nets. Whenever these first two stages were observed in the counts, they were assigned to the species that showed the greatest numbers of stages III and IV.

The difference in spines in stages III-VI proved to be constant and relatively easy to ascertain at normal counting magnification (36X).

The nauplii described by Oberg for *A. bifilosa* and *A. longiremis* were very similar to the *A. clausi* nauplius, but since neither of these species has been recorded from the Sound, confusion from this source is unlikely.

Early Copepodid Stages. The first copepodid stage of all calanoids is a miniature of the adult, with the exception that only the first two pairs of swimming legs are present. During each succeeding molt an additional pair of legs is added until the final complement of five pairs is acquired at stage IV. The relatively shorter urosome and the low urosome-cephalothorax ratio which characterize adult *tonsa* are characteristic of the younger copepodids of this species as well (Fig. 4); for *tonsa*, this ratio is about one to five, but for *clausi* it is about one to three. The caudal rami of stages I-III are nearly quadrate in *tonsa*, but in *clausi* they are always somewhat longer than wide. These characters proved to be constant without intergradations.

Later Stages. Presumably pelagic copepods undergo six naupliar and six copepodid stages between egg and adult, and in copepodids IV-VI it is possible to distinguish between the sexes (Grandori, 1912: plate 10; figs. 171-176, 205-211). However, Grandori described an extra copepodid stage for the male *clausi*, distinguished from the adult only by differences in the fifth swimming leg (*cf.* Grandori, 1912: plate 10; figs. 207-208). Thus far the existence of this extra stage has not been confirmed. Probably it was a recently molted stage VI that was captured before the exoskeleton had become hardened in the adult form.

In stages IV-VI, it is relatively easy to distinguish between *clausi* and *tonsa*. In Long Island Sound, *tonsa* is always larger than *clausi* in the later stages, and the urosome is shorter in relation to the cephalothorax. The most lateral caudal bristle on each ramus is as heavy

and nearly as long as the four middle ones in the case of *tonsa*, but it is definitely thinner and only about half as long as the others for *clausi*. This difference is particularly useful for rapid identification of the males. The fifth swimming legs of the adult *tonsa* female are characterized by a proximal swelling of the end segment, tapering to a coarse toothed central portion and terminating in a thin spine. The fifth legs are symmetrical and are not as described by Wheeler (1901) and figured by Wilson (1932). The *clausi* female has a shorter, less specialized end segment on the fifth leg (see Grandori, 1912: plate 10; fig. 211).

SEASONAL DISTRIBUTION OF *A. CLAUSI* AND *A. TONSA* BASED ON PRESERVED MATERIAL

Annual Variation in Total Numbers of Young and Adults. As mentioned earlier, these two species have a definite seasonal distribution in the Sound. Fig. 5 shows the distribution of all stages of both species. *A. clausi* first appeared in late November or early December 1952, reached maxima in May of both 1952 and 1953, and disappeared in July or early August. *A. tonsa* appeared in June each year, rose rapidly to its midsummer maximum in August, and then decreased more or less steadily throughout fall and winter. A small April peak occurred in both years, after which *tonsa* disappeared for over a month. Apparently this April increase reflected the superabundance of food available to all zooplankton organisms during the spring flowering. The significance of this rise followed by the abrupt disappearance of *tonsa* will be discussed later.

Neither species was as successful in 1953 as in 1952. The maximum number of *clausi* during 1952 was 102,100/m³ on May 21, and the numbers remained well above 50,000 during the following month. In 1953, the *clausi* peak on May 18 was only 61,800, after which the numbers fell off in two weeks to less than half this figure. In 1952, *tonsa* reached its peak of 82,000 on August 19 and the population remained quite high until September 16. In 1953, a maximum of 46,000 occurred on August 5, but one week later the total number had fallen to only 15,500. It is possible that a higher count might have been recorded after August 18, the date when analyses were terminated. However, displacement volumes were measured throughout summer and fall of 1953. While displacement volumes reveal nothing about the abundance of a particular organism, it seems

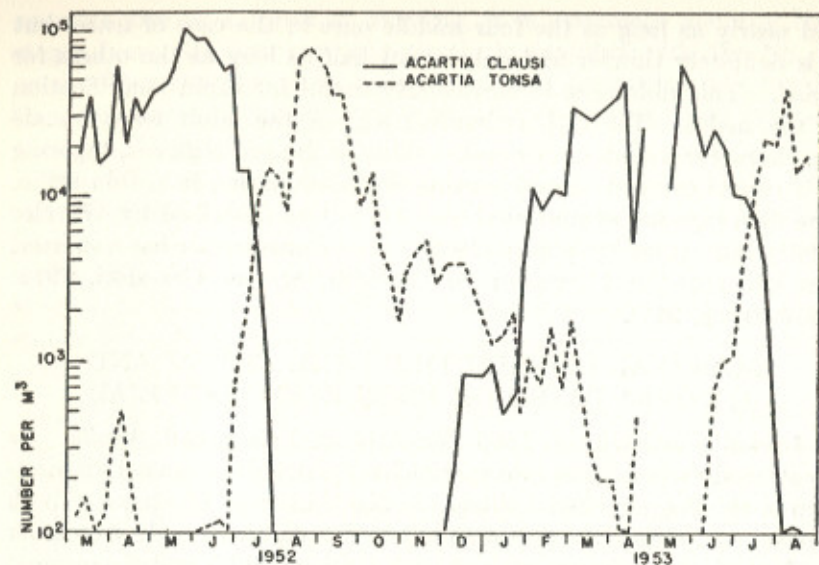

Figure 5. Seasonal distribution of all stages of both species plotted on log scale, No. 10 net.

probable that a late August or early September increase in *tonsa* would be reflected in higher volumes of total plankton. On the contrary, after August 18, volumes of plankton fell away sharply to less than half the August 5 figure of 1.53 cc/m³.

Cell counts and chlorophyll values were lower in spring and early summer of 1953 than they were during the same period of 1952, perhaps accounting for lower numbers of *clausi* in 1953. On the other hand, there was more food available in the late summer of 1953. The major difference in the biological environment of these two species for the two years was not so much the amount of food available as the type of food. There were striking differences in the species composition of the phytoplankton between the two years (see S. M. Conover's paper, PHYTOPLANKTON, in this volume), the quantity of diatoms and other larger phytoplankton elements being greater in 1952. Experimental evidence on food preferences, which will be introduced later, provides a possible explanation for the larger standing crop of zooplankton in 1952.

Seasonal Distribution of Adults. The sex ratio of adult copepods varies considerably in different species and from season to season.

Marshall (1949) found that male *Centropages hamatus* and *Temora longicornis* outnumbered females in Loch Striven whereas females of *Pseudocalanus minutus*, *Paracalanus parvus*, *Microcalanus pygmaeus*, *Acartia clausi*, and *Oithona similis* were more abundant than males during at least part of the year. In that body of water, *clausi* in particular showed a marked seasonal variation in sex ratio; during winter the males constituted only 7.7% of the total adult population of this species, whereas in summer the males often outnumbered the females.

This striking variability in sex ratio does not necessarily reflect differences in actual numbers of the sexes produced. Marshall has shown that, for copepodid stages IV and V, the number of males and females of the seven species mentioned above was nearly equal. Probably variation in the proportion of males to females is dependent on differences in the life span of the adults. If the adult life span of one sex of a certain species is shorter than that of the other, the explanation for the phenomenon may be found in differential success in utilizing the environment. In some species of copepods, notably *Euchaeta norvegica* (Sars, 1903; Nicholls, 1934), the male's reduced mouth parts must be a factor in his longevity. Marshall, in her study of Loch Striven copepods, found an average of less food in the intestines of the males. In the Sound, males of both *clausi* and *tonsa* usually showed less gut contents than females. Respiration and grazing experiments with *tonsa* suggest that the female is more efficient than the male under temperature conditions approximating the natural environment (20° C).

If we assume that the males of certain species are not as efficient as the females, then unfavorable environmental conditions should affect the males first. In the Sound, during periods of low abundance or decreasing numbers, females of each species were more plentiful than the corresponding males (Fig. 6). In the case of *tonsa*, the males and females were about equal in numbers on August 26, one week after the highest 1952 total was recorded for this species, but during the next two weeks the number of adult females increased while the total of all stages (see Fig. 5), particularly that of the adult males, declined (Fig. 6A). With regard to *clausi*, maximum numbers of adults occurred in April 1952, with males actually outnumbering females on April 21. Both sexes then decreased sharply in abundance, but the males declined in numbers even more precipitously

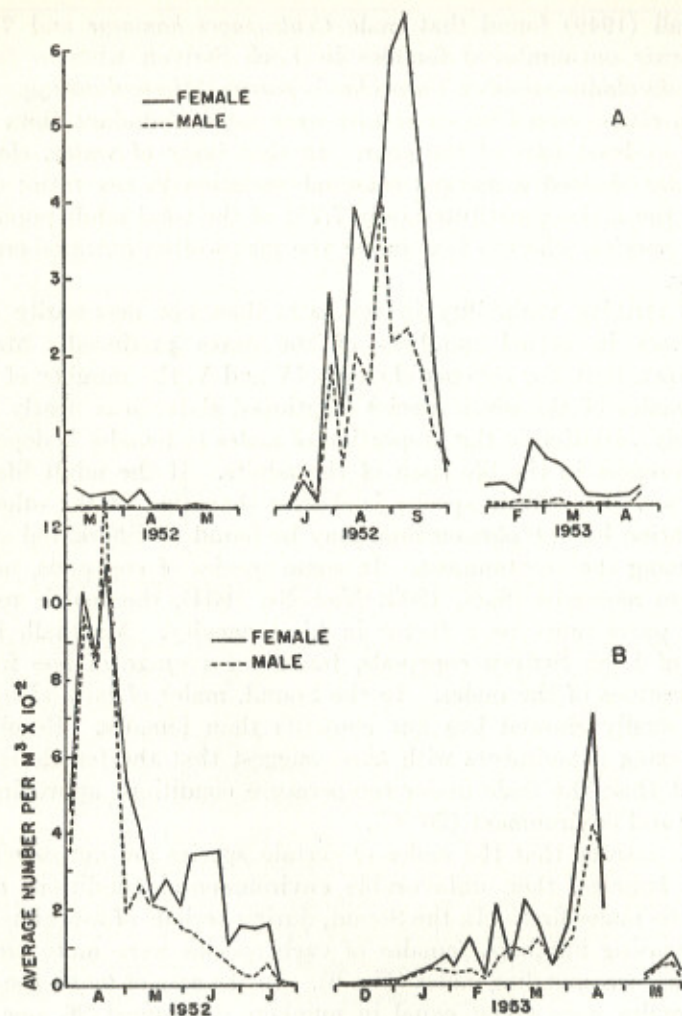

Figure 6. Seasonal distribution of males and females. No. 2 net. A, *tonsa*; B, *clausi*.

than the females (Fig. 6B). Through the rest of the spring, the females outnumbered the males. Total numbers of *clausi* continued to increase during most of May to a maximum on May 21 which consisted largely of nauplii and young stages (see Fig. 5). It is concluded that mid-April rather than May was actually the period

of optimal conditions for *clausi* despite the high total numbers in May.

In 1953 the number of males did not approach the level of abundance found for females. Since the spring totals were considerably lower in 1953 than in 1952, it is suggested that optimal conditions for production of *clausi* were never attained in 1953.

Distribution of Different Stages during Transition Periods. Twice a year in the Sound, once in early summer and again in early winter, both species are taken in the same tow in more or less equal numbers. The distribution of all developmental stages during these important transition periods was investigated. Because development of these copepods is relatively rapid and since breeding is nonsynchronous, it was found necessary to lump together certain developmental stages in order to produce a clearer picture. All nauplii were treated as a unit and the copepodids were grouped into three units consisting of stages I-II-III, stages IV-V, and stage VI. To minimize sampling errors due to nonrandom distribution, the data are presented as percent of total numbers of zooplankton captured. Figs. 7 and 8 show graphically the summer transitions for 1952 and 1953.

Despite certain minor discrepancies in the distribution between the two years, it seems probable that unfavorable environmental conditions affect the younger developmental stages of *clausi* sooner than the adults. The nauplii were completely gone by the end of July, although they persisted slightly longer in 1952 than in 1953. Copepodid stages I-II-III disappeared in the latter part of July about a week earlier than stages IV-V. The adults, last to disappear, were still present in low abundance in August and were taken later in 1953 than in 1952.

A. tonsa nauplii first appeared in early June of both years while the population was still dominated by *clausi*; a few *tonsa* adults, the initial breeding stock, were also found through most of June. In 1953, copepodid stages I-II-III appeared in early June, whereas in 1952 they appeared rather abruptly in July. Stages IV-V rose significantly in numbers shortly after the younger stages started to increase, and by the fourth week in July, the first summer generation adults appeared in both 1952 and 1953.

Breeding was certainly not spontaneous and development was rather irregular, but nonetheless it was possible to ascertain the approximate length of time required for the development of the first

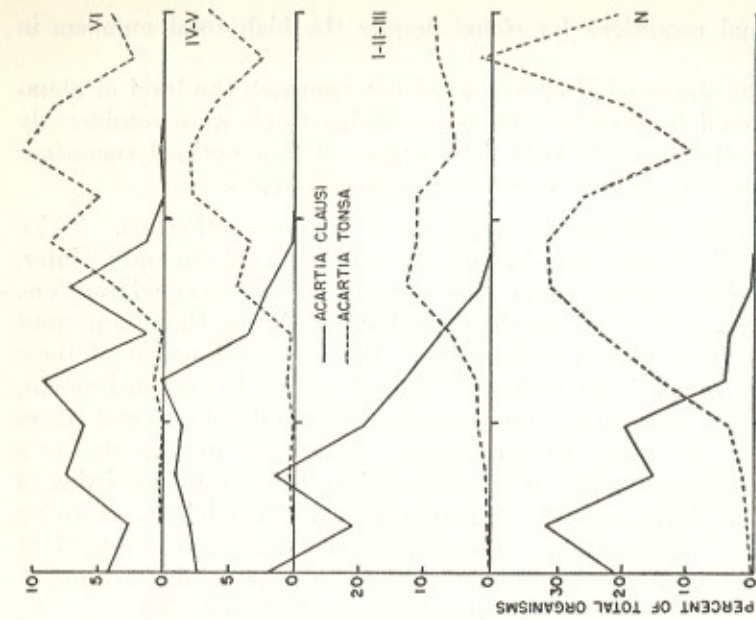

Figure 8. Percent distribution of total plankton of nauplii and copepodid stages during the summer transition period, 1953. No. 10 net.

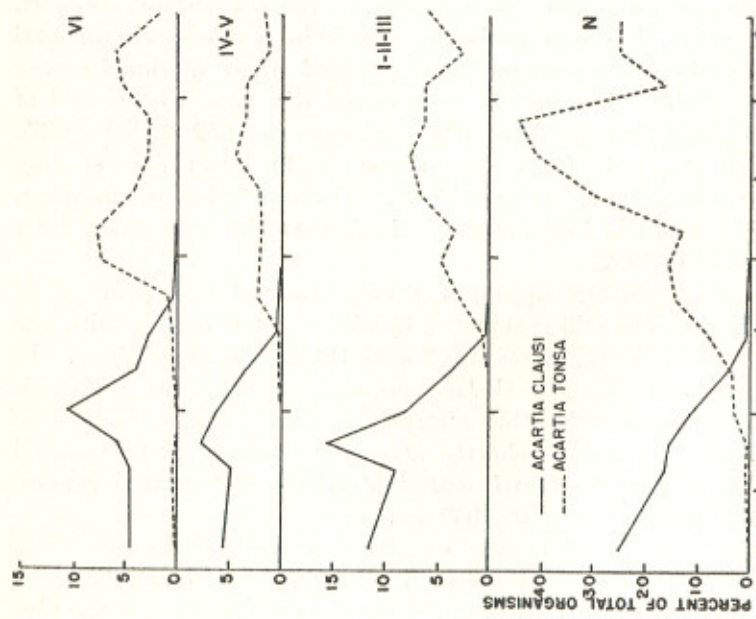

Figure 7. Percent distribution of total plankton of nauplii and copepodid stages during the summer transition period, 1952. No. 10 net.

generation of *tonsa*. Since the first major accumulation of nauplii found during the week of July 1-8 was followed by an initial maximum of adults in late July, it is postulated that complete development under the environmental conditions of the Sound took place in three to four weeks. The data of Marshall (1949) and Digby (1950) suggest four to five weeks as the length of a summer generation of *A. clausi* in British waters, and Nicholls (1933) reported 28 days as the maximum period of development for the much larger *Calanus finmarchicus* in the Clyde Sea area during spring. Considering that Long Island Sound temperatures during July and August are at least 5° C warmer than the maximum summer temperatures in British waters, a three to four week development of *tonsa* from egg to adult seems reasonable.

As would be expected, the winter transition was more gradual and the data clearly suggest that conditions became unsatisfactory for continuous development of the younger stages of *tonsa* (Figs. 9, 10). During December and January, stages I-II-III disappeared progressively from the plankton, despite the fact that a few nauplii were produced throughout the winter. From November through February the total numbers of stages IV, V, and VI did not change significantly (Fig. 9), although a sharp increase in the percentage of adults was recorded in late December (Fig. 10). This peak was unquestionably an artifact which resulted from the final elimination of lingering summer populations of other species before winter forms had become well established. Thus, for a short period the percentage of the more resistant *tonsa* was disproportionately high. The relative uniformity in numbers of later copepodids indicates little recruitment from younger stages. In fact, there was probably little molting at any level.

During winter many of the older stages of *tonsa*, even stages IV and V, were host to a stalked protozoan, while at other times of the year only an occasional large and probably senile adult was found infected. If it is assumed that the incidence of infection will increase with the length of time an individual has been in the water, this observation lends further support to the theory that the *tonsa* population is in a steady state during the cold months.

The behavior of either species could not be determined during the spring flowering, since clogging of the No. 10 net with phytoplankton was so great that quantitative sampling was impossible. Comparison

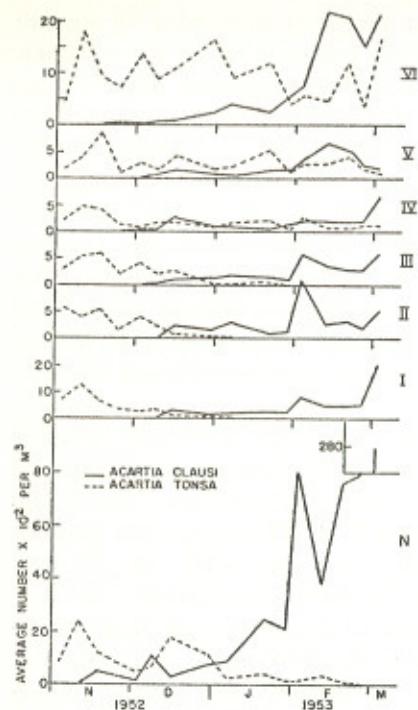

Figure 9. Distribution of nauplii and copepodid stages during the winter transition period, 1952-1953. No. 10 net.

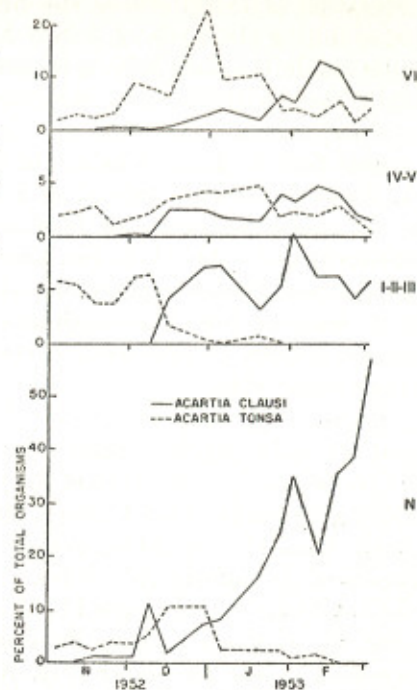

Figure 10. Percent distribution of total plankton of nauplii and copepodid stages during the winter transition period, 1952-1953. No. 10 net.

of preflowering and postflowering data showed higher numbers of *tonsa* copepodids and nauplii in the latter period.

The development of the *clausi* population during winter was gradual and rather irregular. The length of the first generation was undoubtedly longer, perhaps twice as long as the summer estimate of three to four weeks for *tonsa*. Possibly the small but distinct rise in naupliar numbers in early December produced some of the *clausi* adults that matured in late January and early February just prior to the spring flowering. In any case, the abundance of food during the flowering unquestionably set off the great breeding activity as indicated by the nearly fourfold increase in numbers of nauplii between February 24 and March 2. In a few weeks the entire population rose to the high springtime level shown in Fig. 5.

Examination of the gonads of mature females of both species to determine the effect of environmental changes on the reproductive potential of the breeding stock showed that there were always some females capable of oviposition. The number of eggs in the ovary and ducts was not related to the number of nauplii taken in No. 10 net hauls. While no attempt was made to distinguish between the eggs of the various species of copepods found in the Sound, the number of eggs of all species relative to the number of nauplii was greatest in spring and least in summer. The environment surely has some effect on the breeding cycles of adults, but its influence on the eggs and young may have been greater, through control of survival rate and speed of development.

Number of Generations. Digby (1950) postulated at least five generations of *A. clausi* in the waters off Plymouth, England. The data of Marshall (1949) suggest perhaps four generations of this species in Loch Striven. While *clausi* is a year-round inhabitant of these British waters, both authors found that the last generation, produced late in the fall, was not very successful, so that overwintering populations were small.

On this side of the Atlantic, in Tisbury Great Pond, Deevey (1948) found two distinct generations of *clausi* in 1945 and 1946, one of which matured in April and the other in late May and June. Especially notable is the fact that almost no adults of this species were observed from late April to late May. Deevey also noted four generations of *tonsa* in 1945 and three in 1946, but it is possible that a fourth brood matured in the latter year after September 2, when her survey was terminated.

The number of generations of each species of *Acartia* in the Sound was estimated from the distribution of nauplii and adults (Fig. 11). The data are presented on a log plot since this form of presentation minimizes nonsignificant differences in numbers between nauplii and adults and facilitates comparison. The nauplii of each generation are designated by Roman numerals and the corresponding adults in Arabic.

An estimate of four generations a year was obtained using data from 1953 (Fig. 11B) supplemented by the information recorded from 1952 (Fig. 11A). Adults noted about December 1, 1952 have been designated 0. Some of the offspring (I) of this primary breeding stock reached maturity in February and were designated 1. The

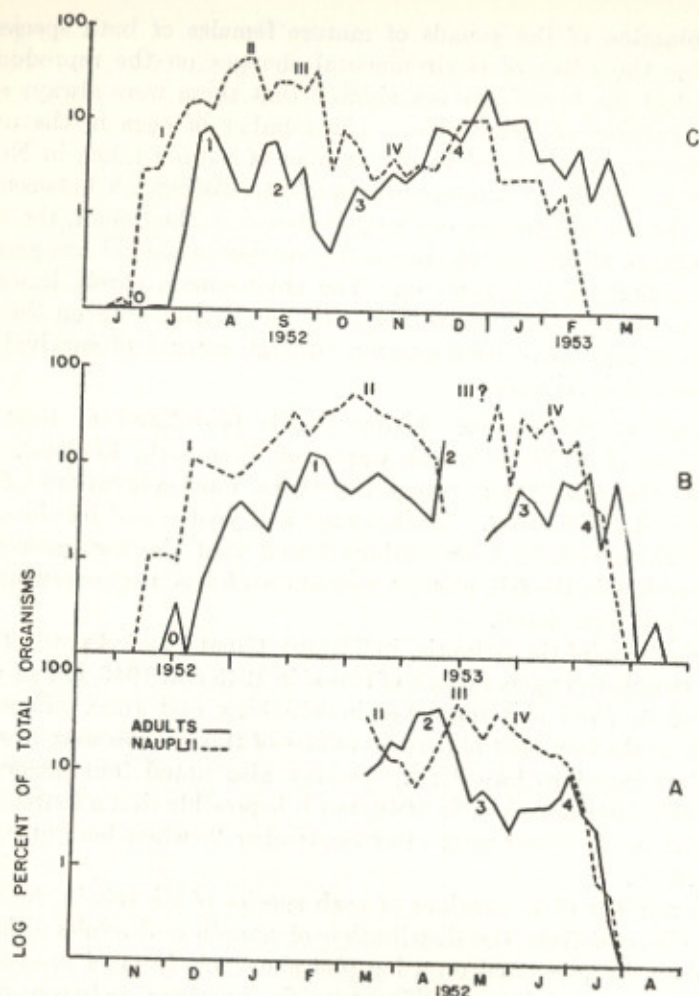

Figure 11. Seasonal distribution in percent of total organisms of adults and nauplii. A, *clausi* 1952; B, *clausi* 1953; C, *tonsa* 1952-1953. No. 10 net.

precise designation of adults 1 is complicated by subsidiary peaks in December and January, but a second naupliar peak II was undoubtedly produced by these adults. Adults 2 matured in April of both 1952 and 1953 and probably produced nauplii III, although a gap in the 1953 data makes the exact date of origin of this generation questionable. Generation 3 adults matured slightly later and were

probably more successful in 1953 than in 1952. Naupliar peak IV, appearing in late May and early June of both years, gave rise to adults 4 which lingered into the summer. Considering the observations of Digby (1950) and Marshall (1949), four generations of *clausi* per year in the Sound are not unreasonable.

The discrepancy between Deevey's observations on *clausi* in Tisbury Great Pond and ours in Long Island Sound is not easily resolved. Tisbury Great Pond, by comparison with the Sound, is such a small body of water and is subject to such extreme variations in temperature, salinity, and probably other ecological factors, that unassessed variables may complicate the picture. As mentioned previously, Deevey observed no adult *clausi* in Tisbury Great Pond for over a month during April and May, whereas in the Sound, these same months are extremely favorable for continuous development. According to Deevey's interpretation, a generation of *clausi* in Tisbury Great Pond would require eight to ten weeks for development from egg to adult; this would seem to be an unusually long life cycle, particularly since the temperature range of approximately 12° to 18° C during this period is clearly favorable for Sound *clausi*.

As in the case of *clausi*, there were probably four generations of *tonsa* annually in the Sound, produced in the period from June through March. In Fig. 11C, the development of the first two generations is clear enough; however, on September 23, a secondary peak of adults appeared which must have produced some of nauplii III. After mid-October, the percentage of *tonsa* in the tows increased while totals of all species were decreasing, suggesting that *tonsa* was more resistant to fall and winter conditions than other summer zooplankton forms. In any event, adult peak 3 appears to be significant. The designation IV applies to low levels of nauplii produced through the cooler months. Possibly a few of the early IV nauplii matured so as to produce an overwintering population which consisted of both adults 3 and 4.

Comparing the Sound with Tisbury Great Pond, it appears that the same number of broods of *tonsa* are produced, but the periods of occurrence are somewhat different, probably due to differences in seasonally controlled environmental conditions resulting from the size discrepancy between the two bodies of water.

Seasonal Variation in Size. The literature on size variation in copepods has been reviewed by Sewell (1948), and it will be necessary

to mention only briefly here some of the more pertinent work. Bogorov (1934) noted that the largest *Calanus finmarchicus* developed in the spring and he concluded that it was the temperature at which the copepod developed that determined its size. On the other hand, Digby (1950) and Marshall, *et al.* (1934) found that the largest copepods developed during periods of abundant food. Difference in the density of the environment may explain the large size of the North Sea population and the smaller estuarine populations of *A. clausi* described by Gurney (1931). Certainly, the large size of *A. clausi* in the Adriatic is primarily dependent on the density of those warm waters (Sewell, 1948). In Block Island Sound, Deevey (1952a)

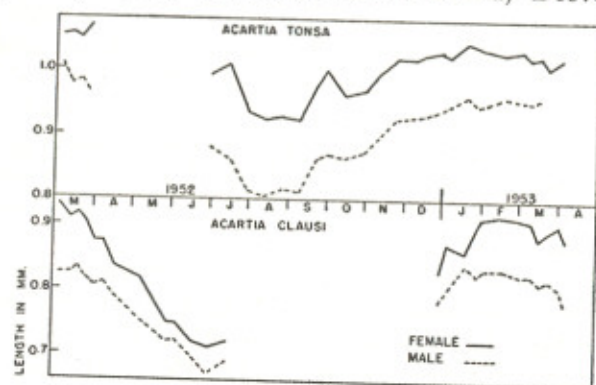

Figure 12. Seasonal variation in length of adults as determined by length of cephalothorax.

noted that *Centropages typicus* increased in size during the winter to a maximum length in early spring. In Tisbury Great Pond, she observed that both *clausi* and *tonsa* of the first generation were larger than those of subsequent generations of the same year (Deevey, 1948).

In our study, measurements were made on the length of each sex and species of *Acartia* collected from the Sound during an entire year (Fig. 12). From March to June 1952, the size of both male and female *clausi* decreased more than 0.2 mm, and in early winter 1953 a rather abrupt increase was noted. In the case of *tonsa*, the sharp decrease in length in July was followed by a gradual increase through fall and winter to its largest size in early spring. The occurrence of the largest specimens of each species was better correlated with the winter temperature minimum and consequently high density than with the spring phytoplankton peak.

Since previous workers have delineated different broods on the basis of size, a similar procedure was followed for *clausi* and *tonsa* of Long Island Sound. Referring to the 1952 data, the decrease in size of the *clausi* females, from over 0.9 mm in late March to 0.84 mm by mid-April, corresponded to the burst of adults designated 2 (Fig. 11A). Another decrease in size corresponded with adults 3 appearing in May. Finally, the small size of the late June and July individuals appeared to confirm a fourth generation of adults.

As for *tonsa*, the maturation of generation 1 about July 29 (see Fig. 11C) coincided precisely with the significant decrease in length shown in Fig. 12. The second brood of adults matured about the first week of September, but no apparent change in size occurred until September 23, when a group of rather large individuals appeared. This sudden increase in size corresponded exactly with the subsidiary maximum mentioned in the previous section. Either our determination of generation 2, as originally defined, is in error and should be disregarded, or else an extra generation developed just after the maximum of adults 2. Certainly two weeks would be an exceedingly short development period, and, moreover, the peak of September 9 was greater in total numbers than that of September 23. Possibly brood 2 actually split into early and late sections. In that event, the early maximum might represent a group which developed more rapidly in inshore waters (slightly lower salinity and higher temperature) while the subsidiary maximum might represent those which developed more slowly under offshore conditions. Worthy of mention in this regard was the moderate chlorophyll peak observed in the inshore waters about the first week in September and a similar peak at the offshore stations two weeks later on the 23rd.

The third brood of *tonsa* must have matured over a period of several weeks. The gradual increase in size during fall and early winter suggests a slow but continuous recruitment of organisms developing under a variety of temperature and food conditions.

To determine as precisely as possible the age structure and behavior of these different broods, a series of frequency diagrams for adult females of both species has been prepared (Fig. 13).

A single brood should be characterized by a histogram that closely approximates the normal curve, with the majority of individuals falling into rather narrow size limits. On March 5, 1952, the size distribution for *clausi* was quite uniform, with the majority of in-

dividuals falling between 0.91 and 0.95 mm; these animals could have been remnants of generation 1 (see Fig. 11). In the succeeding weeks, smaller individuals appeared until on April 2 a reasonably homogeneous group was found with a mode about 0.87 mm. This histogram probably represents adults of generation 2. During the next few weeks, several size categories were found, so that precise delineation of generation 3 was difficult. On April 9 a small group of animals (0.82 to 0.84 mm) appeared which could be followed through to May 8, but the histogram for May 24 fitted the theoretical criteria for normality better and was therefore considered typical of brood 3. The narrow spread and smaller mean of the histogram for July 1 suggests that these individuals constituted a definite fourth brood.

It is also possible to obtain an estimate of the length of adult life from these data. If the few large specimens found in mid-April tows are considered members of brood 1, which developed during the winter, the adult life of this early spring generation must have been a month or more. Some members of brood 2 were still present on May 8, approximately a month after they first appeared. Females of generation 3, which were noted on May 24, in all probability had nearly disappeared by July 1, despite the apparent bimodality of the July 15 distribution. Thus one month was about the maximum life span for an adult female *clausi* during the spring, but undoubtedly the life span was considerably longer during the winter.

Referring to the data on *tonsa*, a striking drop in size was apparent during the latter part of July in 1952; the larger females taken on the 15th probably represented remnants of the breeding stock 0, whereas the smaller ones obtained on the 29th represented generation 1. There was no further change in the size structure of the population until September 23, when the group of large individuals of enigmatic origin appeared distinct from those found on September 9 (brood 2). The platykurtic nature of the frequency diagrams during the cooler months of the year, for *clausi* as well as *tonsa*, lends confirmation to the theory that breeding and development is retarded and somewhat erratic during the winter.

One other point is suggested by the size data. The adult *tonsa* taken on July 15, 1952 were actually about the same size as those observed the following spring, March 16, 1953, the mean lengths being 1.009 mm with a standard deviation of 0.0318 and 1.022 mm with a standard deviation of 0.0555. Although these broods are not

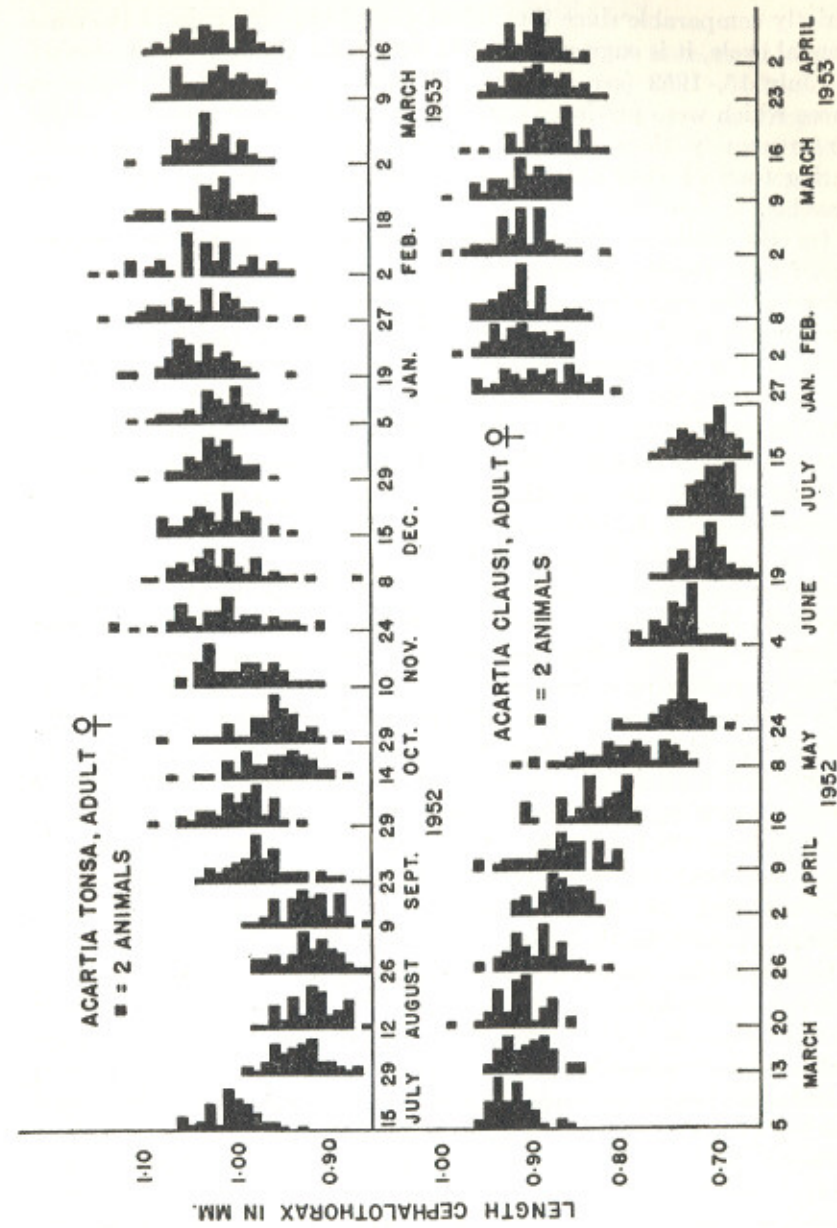

Figure 13. Size distribution of adult female *clausi* and *tonsa* at different times of the year, 1952-1953.

strictly comparable since they developed at opposite ends of the same annual cycle, it is suggested that at least some of the adults measured on July 15, 1952 (see Fig. 12) belonged to the same generation as those which were produced earlier, during the cooler months of 1952. Unfortunately there were not enough adult females in the early spring tows of 1952 to make statistical confirmation of this theory possible.

On the basis of 1952-1953 measurements, summer and winter *clausi* were clearly different broods, but no measurements were obtained of the first *clausi* which appeared in the fall of 1952. In 1953, measurements of random samples taken on July 22 and November 11 indicate that some spring *clausi* might have survived until fall. While the mean lengths of these two samplings, 0.732 and 0.761 mm, were significantly different statistically, a frequency diagram for the November date suggests that more than one brood was represented; at least half of the measurements fell within the size limits of the July sample and the rest were definitely larger.

If a population is to survive unfavorable seasonal conditions, some means of maintaining a breeding stock must exist. In marine copepods there is no direct evidence for "resting" eggs as in some freshwater forms. While immigration from other regions is a possible means of supplying a breeding stock, in this case it seems unlikely. The pattern of circulation for the Sound is such that bottom water enters from Block Island Sound and moves west at an average speed of only half a kilometer per day. Moreover, Deevey (1952a, 1952b) found *Acartia* spp. a minor element in Block Island Sound, and *tonsa* often appeared in Long Island Sound first. Possibly *clausi* and *tonsa* never disappear completely from the water column but merely become scarce enough to remain unnoticed; however, the breeding stock always appeared suddenly and in considerable quantity. Or possibly a few organisms survived unfavorable conditions in low abundance in some unsampled area. In this regard, it is worth mentioning that Howard Sanders (personal communication) found *clausi* in a good state of preservation in bottom samples collected on June 30, 1953, a date when *tonsa* was increasing in numbers and *clausi* was decreasing (see Fig. 5).

COMPARATIVE PHYSIOLOGY

Thus far, differences in seasonal distribution have been emphasized, and generalizations have been made concerning the relationships of the organisms to seasonally determined variables such as temperature and food. In the following sections, the effect of certain ecological factors is investigated, usually under controlled laboratory conditions, in order to learn more about the mechanism of environmental control over the copepods.

At least five oceanographic parameters which might affect a marine animal show marked seasonal variation in Long Island Sound, namely, dissolved oxygen, salinity, light, temperature, and the amount of phytoplankton, but the first two probably have little influence on the local zooplankton fauna. Marshall, *et al.* (1935) found that respiration in *Calanus finmarchicus* was independent of oxygen concentration above 3 ml/l. Although no experiments have been performed to test the effect of oxygen concentration on Sound copepods, there is no evidence that variation in oxygen concentration within the range observed in nature affects their metabolism. In the Sound, the waters just above bottom may fall below 3 ml/l in late summer, but through most of the water column oxygen concentrations remained well above 50% saturation. Nor should seasonal changes in salinity have a noticeable effect on *clausi* and *tonsa*. Both are extremely euryhaline copepods. Davis (1944) found *tonsa* in Chesapeake Bay waters that varied in chlorinity from 0.4 to nearly 19‰; Sewell (1948) gave 0-36‰ as the salinity range for *clausi*. Marshall, *et al.* (1935) noted that respiratory rates of *C. finmarchicus* remained unchanged with a 20% dilution of sea water. If the relatively stenohaline *C. finmarchicus* could withstand a 20% dilution of its environment over the course of a few days without any obvious change in metabolism, certainly the euryhaline *clausi* and *tonsa* should not be seriously affected by a 6-8% dilution of Long Island Sound over a period of several months. On several occasions, Deevey (1948) noted a sudden decrease in the numbers of *tonsa* accompanying a sharp rise in salinity when Tisbury Great Pond was opened to the sea. However, her evidence did not indicate whether the population was actually harmed by the increased salt content or simply diluted by the outside water. In any event, the minor seasonal fluctuations in the Sound are considered a doubtful determinant of the behavior of *clausi* and *tonsa*. For these reasons, major attention has been devoted to study of the

effect of light, temperature, and kind and abundance of food. Most of the experiments were designed to compare the effects of the different variables on the two species.

Light Responses

A. tonsa and *A. clausi*, like many other zooplankters, undergo diurnal migration in the sea. This behavior has been duplicated in the laboratory with natural and artificial illumination (Schallek, 1942). A preliminary experiment was performed on October 10, 1952 to see whether Sound *tonsa* behaved as predicted. Two large graduated cylinders filled with sea water were placed in a window and shielded from direct sunlight. Some *tonsa* were added to each cylinder, and the one designated B was hooded to keep out the light. Counts were made at four levels in the cylinders at approximately three hour intervals for an entire day. The results are presented in Table I.

TABLE I. VERTICAL DISTRIBUTION OF *Acartia tonsa* IN RESPONSE TO VARIATION IN AMOUNT OF NATURAL LIGHT

Vessel A (uncovered) Depth	Number of animals at each level at different times of day									
	0900	1200	1500	1800	2100	0000	0300	0600	0900	
1 (surface)	4	4	14	19	20	14	24	11	12	
2 (intermediate)	5	2	1	5	10	9	5	10	12	
3 (intermediate)	2	5	2	3	3	9	1	1	1	
4 (bottom)	2	4	0	3	2	2	1	1	4	
Vessel B (covered) Depth										
1 (surface)	0	15	6	18	12	11	14	18	15	
2 (intermediate)	13	9	16	12	12	14	10	16	9	
3 (intermediate)	8	11	9	11	14	1	6	4	7	
4 (bottom)	11	7	8	2	3	3	7	2	6	

The copepods in the dark cylinder (B) maintained a relatively unchanged distribution, with greatest concentrations in the upper layers. No innate rhythm of migration in the absence of light was observed. In cylinder (A), exposed to daily changes in light, the greatest numbers were noted in the surface layers between 1800 and 0300, the hours of darkness. At 1500 there were some animals in the upper layers; perhaps due to shorter day length at this time of year, there was sufficient diminution of light to start some organisms on their upward migrations. Twelve animals were still lingering in the surface waters by 0900 the next morning, but the majority had descended to the bottom. Organisms directly on the bottom could

not be counted; hence bottom counts were made on only those organisms swimming in the bottom one inch of water.

Although copepods remain in deeper water during the day, some species, including *clausi* and *tonsa*, are attracted to direct light. When light has directionality, it strikes only one region of the photoreceptor and the copepod swims towards the source. But if the light is made diffuse, as by passing through a quantity of water, it strikes the photoreceptor from several directions simultaneously; under these conditions the animal ceases to swim and sinks to the bottom of a vessel or to some threshold level in the sea (Schallek, 1942).

Effect of Temperature on Light Responses. Because seasonal temperature changes appear to play an important rôle in the control of *Acartia* populations, an experiment was designed to compare light reactions of both *clausi* and *tonsa* at different temperatures. Four 2000 ml graduated cylinders were filled with sea water to the two liter mark. Fifty *clausi* were added to two of these cylinders and fifty *tonsa* to the other two. One cylinder containing *clausi* and one *tonsa* were placed at 15° C; similar tubes were placed at 4° C; all tubes were allowed to equilibrate several hours in darkness. Observations were made as follows: after five minutes of direct overhead illumination; after five minutes of diffuse illumination following two hours for re-equilibration; and after a two hour period of darkness. Diffuse light was produced by placing several thicknesses of rice paper over the cylinder; although no single point of illumination was present, the light intensity was not uniform from all directions. Distribution was ascertained by rapid counts of the organisms observed in 200 ml of water at four levels in each cylinder; the general abundance in the intervening regions was also noted.

Comparison of the results showed no essential difference in the responses of *clausi* and *tonsa* to direct light at 15° (Fig. 14). On the other hand, at 4° less than half as many *tonsa* were attracted to the light while the response of *clausi* was about the same as at 15° C. Examination of the 4° cylinder containing *tonsa* showed that many were dead or dormant on the bottom, but when the tube was warmed to 15°, a normal response to direct light could be elicited.

Diffuse light at 15° appeared to provoke a different response from each species. When the light was turned on, most of the *clausi* ceased to swim and, with head up and antennae outspread, sank toward the bottom. A few aberrant animals started to sink but then swam

upward for a short time, thus remaining more or less in one region. Although some *tonsa* started to sink immediately, a large percentage swam upward toward the area of most intense illumination. At 4° most individuals of both species underwent the sinking reaction under the influence of diffuse light.

In darkness at 15°, both species tended to congregate in the upper waters as they did in the experiment discussed previously (see Table I). Again at 4°, the *tonsa* response was much weaker; few animals apparently made an upward migration in the dark. Thus temperatures approaching winter levels in Long Island Sound might produce

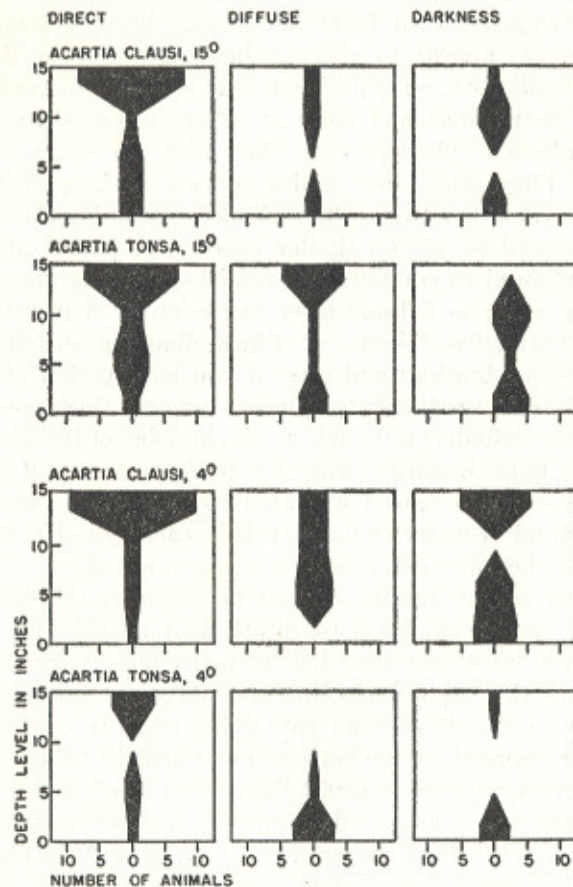

Figure 14. Vertical distribution under laboratory conditions in response to direct light, diffuse light, and complete darkness at two different temperatures.

in the two species different reaction to light and, consequently, different vertical distribution.

Vertical Distribution in the Sound. On the basis of this and other experiments in which temperature was a factor, a study was made of the vertical distribution of the copepods throughout the year, paying particular attention to the distribution in relation to the thermocline when present. Periodic tows with the Clarke-Bumpus sampler and No. 2 bolting silk nets were made at two depths, one in the upper five meters, which was intended to sample the water above the thermocline, and the other near the bottom. In conjunction with these tows, a bathythermograph trace was usually obtained to establish the temperature distribution within the water column.

Before comparison of the vertical distribution of animals and temperature could be made, the depth of the tow had to be ascertained. The approximate depth at which the plankton sampler was operating was estimated from the amount of towing wire and the wire angle, using a correction for curvature of the wire. The correction was derived from statistical examination of cases in which the weight on the end of the wire dragged bottom at known depths.

The results of these tows, taken at intervals from April 1953 through July 1954, have been plotted in Fig. 15. The histograms represent the percentage of adults and copepodids of each species in the total plankton. The base of each histogram indicates the temperature at which the sample was taken. The histograms are arranged so that surface tows run toward the top of the illustration and the deep tows toward the bottom. The heavy horizontal line approximates the position of the thermocline during the spring and summer months. Actually, this figure represents the top of the thermocline. The bathythermograph record was read at intervals of 2.5 m; when the depth interval showing the greatest gradient was located, the higher temperature was used as the thermocline temperature.

In the spring of 1953 the greater percentage of adult *clausi* remained in the cooler waters beneath the thermocline during the day. On the basis of actual numbers per cubic meter the difference in concentration between surface and deeper waters was even more exaggerated. Night tows in the early spring indicated no restriction of vertical migration by the thermocline, but in June there were fewer adult animals in surface waters at night, suggesting that the thermocline serves as a kind of barrier when the surface waters have warmed to

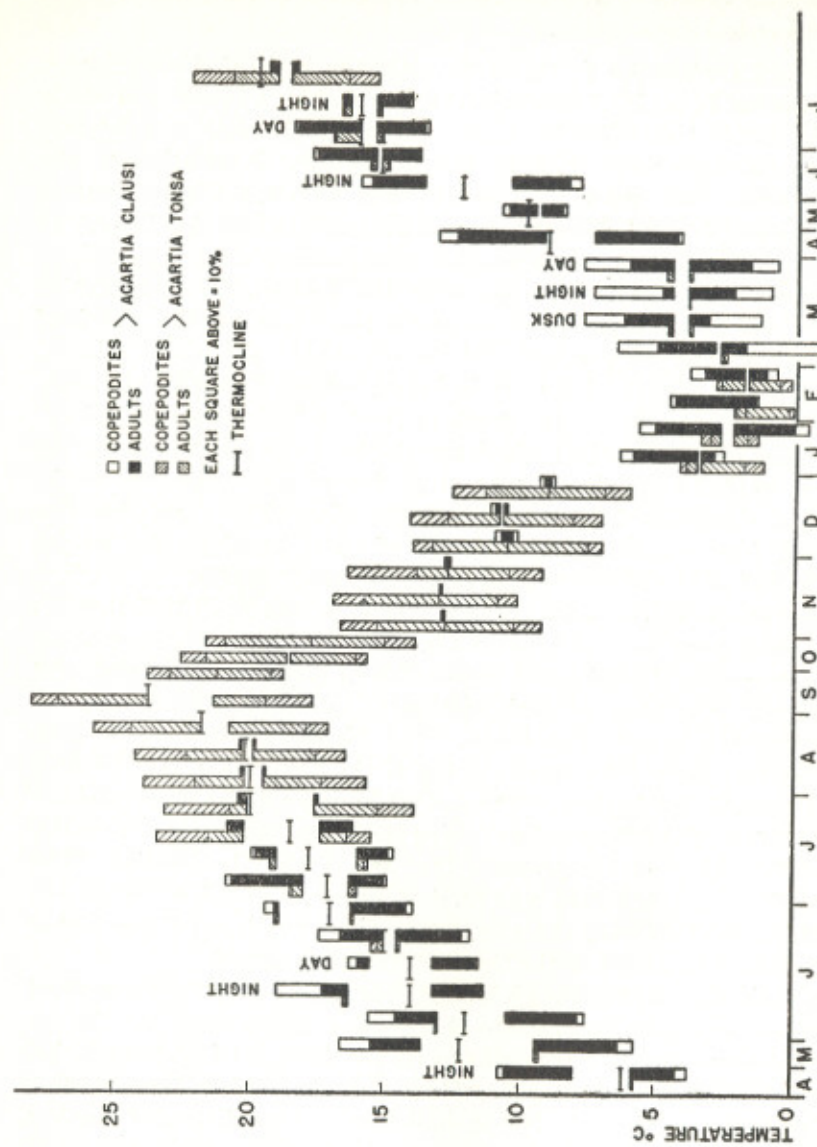

Figure 15. Vertical distribution of the *Acartia*, percent total plankton. See text, p. 187.

some critical level (16° to 18° C). Throughout this period the developmental stages of *clausi* remained more abundant in surface waters both day and night. By July the adults as well as the copepodids were more frequently observed in the upper waters regardless of the time of day. Perhaps when the bottom waters become warmed beyond a certain point, they no longer serve as a refuge for *clausi*. At this stage in the seasonal cycle, the marked decline in total numbers of *clausi* began and the younger stages particularly became scarce in the plankton (see Fig. 5).

In the summer of 1953, the daytime surface tows almost always contained more *tonsa* than deep tows. *A. tonsa* has been seen actually struggling against the surface film on a bright day when there was no wave action (Shirley Conover and Howard Sanders, personal communication). Though light from the sky would normally be scattered by wave action, it is possible that the rays of the sun are sufficiently direct on a calm day to cause a phototactic response. Moreover, in the laboratory, *tonsa* responded to differences in light intensity even though the light was not directional (see Fig. 14). Thus, if the summer sun is fairly bright and the water surface relatively smooth, significant numbers of *tonsa* might collect in the surface waters during the day.

From mid-September to mid-December the water column was subject to more or less complete mixing and the percent distribution of both species was about the same. Cold spells in December and January lowered the water temperature to below 4° C, where it remained for over two months. During this time, the number of *tonsa* decreased gradually while *clausi* became increasingly important in the plankton. The most interesting feature of the cold water samples was the greater concentration of *tonsa* in deep water. Although no information on the nocturnal behavior of these species was obtained during this period, the laboratory behavior of *tonsa* (see Fig. 14) was in complete agreement with the winter field observations.

Data collected during the spring and early summer of 1954 proved to contradict somewhat the results obtained during this period in the previous year. On March 30 tows were taken in the evening and at night, and on March 31 during daylight. The highest percentages of *clausi* adults were found in surface waters at dusk and in bottom waters during the day; however, the number of adults in the

surface sample at night was low, perhaps due to the meteorological conditions at the time. The average wind speed on these dates at New Haven was over 10 mph, with gusts over 20 mph, and it is probable that the wind speed at sea was even greater. Under such conditions there may have been sufficient instability in the water column to disturb the normal plankton distribution. Moreover, the night tow of March 30 was taken during a severe snow squall; Schouteden (after Cushing, 1951) found that sudden rain or hail drove Crustacea to lower levels at night.

Subsequent observations might also be explained by weather conditions. Rather high numbers of *clausi* were taken at the surface in daytime on April 27 when moderately strong easterly winds were recorded. In the Sound, a sizable swell develops with an easterly wind, and since the thermocline was not particularly strong at this time, considerable mixing of surface and deeper waters may be assumed.

Comparison of the hydrographic data for the spring and summer of 1953 and 1954 showed a higher degree of stability in the former year. In 1953, a reasonably strong thermocline existed, frequently extending down 10 m or more at the deep stations; the temperature difference between surface and bottom in spring and early summer averaged about 3° C and was often considerably greater. In 1954, the vertical temperature difference resulted principally from short term surface warming in the upper 2-3 m and a sharp thermocline was infrequently observed. The BT trace often showed several steps between surface and bottom. On May 10 and July 22, so-called surface tows appeared to be below the thermocline, although they were taken at 5 and 4 m respectively. On both dates, the vertical temperature gradient was small and principally in the upper surface layer. If stability conditions comparable to the previous year had existed, these tows would have sampled the warmer epilimnion.

Though the evidence is inconclusive, the vertical distribution of *clausi* at least appears to be affected by the degree of stability of the water mass and the presence of a thermocline.

Response of A. clausi to an Experimental Thermocline. To supplement field observations, an experiment was designed to study the effect of an experimental thermocline on *clausi*. Four two liter graduates were filled with sea water and 50 *clausi* were added to each. Two graduates, designated 1 and 2 in later discussion, were partially

submerged in a constant temperature bath of about 13° C, with the upper half exposed to room temperature (18-20°). Within a few hours, examination of the temperature distribution in these cylinders showed that a definite thermocline had developed. The other cylinders, 3 and 4, were completely exposed to constant temperature equal to about that of the bath (13°). Cylinders 2 and 4 were hooded to keep out the light while 1 and 3 were exposed to periods of night and day. Distribution was checked in the manner mentioned previously (p. 185), and the temperature at each level was recorded after each count. The histograms in Figs. 16A and 16B represent observations at about 0100 and 1100 respectively. Histograms I and II represent the distributions observed in cylinder 1, with thermocline and natural light conditions; III and IV, results from cylinder 2, with thermocline and constant darkness; V and VI, results from cylinder 3, with uniform temperature and natural light; VII and VIII, results from cylinder 4, with uniform temperature and constant darkness. The vertical row containing histograms I, III, V and VII gives the distributions before illumination, and similarly II, IV, VI and VIII give the results after five minutes of exposure to direct overhead light. Thus each horizontal row contains observations on a single cylinder and each vertical row indicates identical observations on each of the four graduates. The small graphs in the middle give the temperature distribution in each cylinder at the time of observation.

The animals kept at uniform temperatures in cylinders 3 and 4 behaved as expected (see Fig. 14, Table I); at night or in darkness, they gathered in the upper waters, and they demonstrated a strong phototactic response to direct light at any time of day. However, in cylinders 1 and 2, which contained the artificial thermocline, few animals were found in the upper water under any conditions. Even direct illumination did not induce the copepods to cross the thermocline, but instead most of them congregated near the middle of the cylinder right at the thermocline.

Obviously the experimental thermocline used here has been greatly compressed; that is, a vertical temperature difference that normally extends throughout a column of water 15-20 m deep has been produced in a graduated cylinder only 15 inches deep. Thus the observed response of the organisms is probably greatly exaggerated. Nonetheless, this experiment seems to indicate that a strong vertical

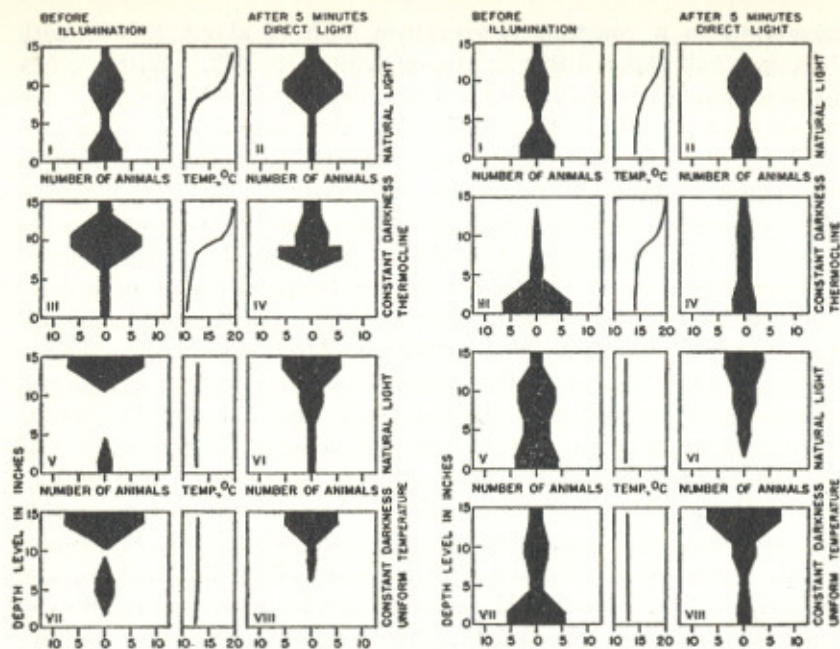

Figure 16. Vertical distribution of *clausi* in response to an artificial thermocline. A (left), night; B (right), day. See text, p. 191.

stratification might closet one or more species into a separate compartment within what is often considered a homogeneous environment.

It is clear that the thermocline *per se* does not present an invisible barrier through which no animal can penetrate. Moreover, different planktonic organisms have widely different ranges of temperature tolerance. Cushing (1951) summarized the probable situation adequately in stating: "It is a possibility that a homogeneous group of animals (stage, sex or brood of a species) has a temperature range, beyond the extremes of which the animal does not appear; a thermocline near the limits of this range will be obviously more effective in modifying migration than one in the center of the range." The behavior of *clausi* would seem to be in agreement with this interpretation. When temperature above the thermocline remains below 15–16° C, at least some animals can cross it, but there is evidence that diurnal migration is restricted by a thermocline as the temperature of the surface water rises. Under these conditions, *clausi* becomes partially isolated from a section of its environment.

Response to Colored Light. Lumer (1932) noted that four species of *Cladocera* showed a higher degree of stimulation by red-orange light than by any other color. More recently, Smith and Baylor (1953) found that *Daphnia* swam toward or parallel to a beam of red light but swam perpendicular to or down from a beam of green or blue light. These authors also found that *Daphnia*, when cooled, lost their response to blue light and swam only the red "dance," with the principal vector in the vertical; however, by increasing the light intensity Smith and Baylor could cause downward swimming again. Experiments on both species of *Acartia* with various monochromatic filters under different temperature conditions showed that their response to visible light was essentially the same at either end of the spectrum. The result, therefore, was negative.

The principal difficulty with light experiments on these two species has been the lack of any criteria for orientation other than by attraction or movement toward light. Spooner (1934) noted that *Acartia clausi* was phototactic but that its movement toward light was completely unoriented. Our observations also indicate little orientation of the body to light, but the movement toward light was usually zig-zag, with a constant angle to the beam of light. Both species were attracted in the same manner to each of the different filters regardless of temperature, but the degree of attraction of *tonsa* was several times greater (*i.e.*, more animals appeared at the light) at 16° than at 4° C. In an earlier experiment, the apparent sluggishness of *tonsa* at low temperatures was demonstrated; however, this experiment suggests that such behavior resulted from a narcotization of the organism rather than from an actual physiological change brought about by lower temperature.

Oxygen Consumption by *clausi* and *tonsa*

If temperature affects activity, as indicated by preceding experiments, then some measureable indicator of physiological activity, such as oxygen consumption, may be affected also. However, finding a suitable method for respiratory measurement has presented a problem. Although some extremely sensitive monometric equipment has been developed in recent years, in almost every case increased sensitivity has been attained by reduction of the volume of the apparatus. To be sure, a copepod is a small creature and does not use much oxygen, but it is an extremely active one. Zeuthen

(1947), using the Cartesian Diver for respiratory measurements with *Centropages hamatus*, found a steady decline in oxygen utilization accompanied by a visible decrease in activity over a 10-12 hour period. Marshall, *et al.* (1935) used the Winkler method for similar studies on *Calanus finmarchicus*, and when the data for both experiments were converted to comparable units, Zeuthen's results were approximately 25% lower than those of Marshall and co-workers. Since Zeuthen used a smaller animal of a different species, differences in oxygen utilization might be expected. It is also possible that the oxygen bottle method caused more initial disturbance than the "diver," but present investigations indicate that healthy copepods do not become less active with time. In Zeuthen's experiment, *C. hamatus* was confined to a volume of water only a few times greater than its own volume; perhaps his values should be considered with reservation since they were obtained under such highly unnatural conditions.

Methods. Two means of measuring oxygen consumption have been employed here. Some measurements were made with the Warburg constant volume type respirometer, but this equipment had two major disadvantages: it was possible to run respiration studies at only one temperature at a time; and an inconvenient amount of material was required to obtain significant results, even with the 5 ml flasks. Hence this technique was used only as a check on the second method. More satisfactory results were obtained with a modification of the water bottle method employed by Marshall, *et al.* (1935) and later by Riley and Gorgy (1948). Glass-stoppered bottles of approximately 35 ml volume were filled with sea water, and to these were added 50 *clausi* or *tonsa*. Berkefeld filtered sea water of known oxygen content was then added to the bottles by flushing three times, using a siphon arrangement; a bolting silk screen over the outflow siphon prevented escape of the animals. By means of neutral dyes, it was found that the rate of flow through the experimental bottle could be adjusted to give complete flushing with about 100 ml of water. Controls were prepared in exactly the same manner except that no copepods were added. Both experimental and control bottles were then immersed in constant temperature baths from 4 to 12 hours, depending on the temperature. Simultaneous measurements of oxygen utilization at several temperatures were obtained by the use of different constant temperature baths which were simply large

wash tubs fitted with compressed air stirrers and thermoregulators. All baths were kept in a constant temperature room at about 4 to 5° C, and therefore they could be adjusted to any higher temperature. The temperatures employed were usually 5, 10, 15, 20, and sometimes 25°. At the end of each experiment, the oxygen content of the experimental and control bottles was measured by the Winkler method, modified for use with the 35 ml volume; the oxygen consumption by the copepods was obtained from the difference between the two. Winkler titrations were made with a self-filling 10 ml burette graduated in fiftieths of a milliliter. By dividing drops, as little as 0.01 ml of thiosulfate could be added at a time.

Although the titrations were carried out with great care, certain undetermined sources of error were introduced. Thompson and Robinson (1939) found that the loss of volatile iodine could be significant when small volumes were titrated. As a check on the accuracy of our analytical procedure, 20 replicate samples of sea water were prepared and titrated in the usual manner. One series gave a mean titer of 5.8185 ml/l oxygen uncorrected with a standard deviation of 0.02439, while a second series gave 5.7895 and 0.01792 respectively. Using the second series, a difference of 0.36 ml oxygen per bottle between experimental and control bottles would limit the error to 10% in 68 experiments out of 100. Although a titer difference of 1.08 ml oxygen per bottle would practically insure an error of 10% or less, it was impossible to assure a difference of over 1.00, particularly at low temperatures, without making the experimental technique impractically tedious. However, a titer difference of 0.36 ml per bottle was usually obtained; in the comparative experiments, analytical errors were probably systematic.

The copepods used in these experiments were obtained with a coarse tow net on the day preceding the experiment. They were diluted several times in the laboratory with raw sea water and then placed at a constant temperature of 4 or 13° C depending on the season. Unless the animals were to be kept longer than overnight, they were not fed. Animals of the desired sex and species were isolated from the diluted samples with the low power of a dissecting microscope and placed directly in the experimental bottle. After the experiment, the Winkler reagents were added directly to the containers before the animals were removed. Care was taken to avoid the loss of animals during the addition of Winkler reagents

or in titration. The animals were then counted and the length of the cephalothorax was measured with an ocular micrometer. Although there was some shrinkage with this Winkler "preservation," the error was less than 3%.

After the experiment was set up, a portion of each tow was preserved in formalin for later analysis of size and weight. For dry weight determinations, a thousand copepods, usually of one sex and species, were sorted from the preserved tows with the aid of a dissecting microscope. A random sample of 50 was measured with an ocular micrometer before desiccation so that a correction could be applied in the event that those used for respiratory experiments differed in size from those weighed. Since both weighed and experimental animals usually came from the same tow, such differences were not great. Once isolated and measured, the copepods were removed to a fine-pore filtering crucible which served as a weighing container. After several washings with distilled water to remove the soluble contaminants, the animals were dried in air at about 80° C overnight, or until constant weight was obtained. Before weighing, the crucibles were allowed to cool in a calcium sulphate desiccator of standard design.

Pilot Experiments. Before comparative studies of these two species were begun, several pilot experiments were run to establish a reasonable experimental procedure. There was no essential difference in oxygen consumption when the same number of copepods was placed in bottles of different sizes, nor was there a difference in the respiration of different numbers of copepods in bottles of the same volume. When the water bottle method was checked against the Warburg procedure, fair agreement was obtained.

In order to determine if oxygen was used by the copepods at a constant rate, replicate experimental and control bottles were prepared and placed simultaneously in a constant temperature bath. Oxygen determinations were then made after different time intervals. When bottles were removed at four hour intervals (Fig. 17A), *clausi* appeared to have an initially higher oxygen consumption which leveled off to a constant rate after 12 hours. When the time interval between oxygen determinations was shortened to two hours, the leveling off occurred much earlier (Fig. 17B). In this case, the observations suggest that the initially high period of oxygen uptake was followed by a short recuperation period in which oxygen utiliza-

tion was less than "normal." A similar experiment with *tonsa* gave high initial oxygen consumption rates with a level period between 6 and 16 hours; after 16 hours the rate of oxygen uptake decreased again.

Because bacteria could not be eliminated as a possible source of error in respiratory experiments, comparison of the growth rates of bacteria in experimental and control vessels was made. Below 15° C no significant bacterial growth occurred over the normal experimental period, but at higher temperatures results were somewhat

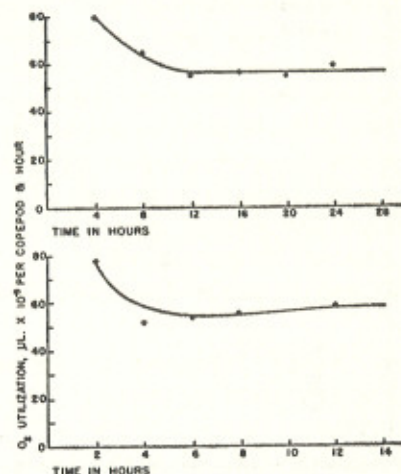

Figure 17. Oxygen consumption of *clausi* at 15° C plotted against time. A (top), Bottles removed at four hour intervals; B (bottom), Bottles removed at two hour intervals.

variable. However, an error greater than 10% occurred only once. In these experiments, it was necessary to assume that the growth of those suspended bacteria which can multiply on the sea water agar provided an index to the growth of all bacteria in the bottle. If this assumption is correct, bacterial respiration would seem to be of minor importance under the conditions employed in these experiments, and even if this assumption is not correct, errors due to bacterial respiration should cancel out in the comparative studies.

Effect of Light on Respiration. Marshall, *et al.* (1935) found that the oxygen consumption of *Calanus finmarchicus* increased up to 50% when exposed to natural light, but when the copepods were placed in bottles suspended in the sea, this stimulatory effect was not

present below 0.5 m. Artificial light had no effect on respiration. In the Sargasso Sea, Riley and Gorgy (1948) found that respiration of zooplankton in light bottles was 16% higher than that of similar specimens in dark bottles. Klugh (1929, 1930) has shown that the ultraviolet component of daylight is harmful to a number of marine animals. It is probable that the high respiratory rate observed for animals exposed to natural light represents an injury response.

Several experiments were run to determine if artificial light affected the respiratory physiology of *clausi* and *tonsa*. Light was provided

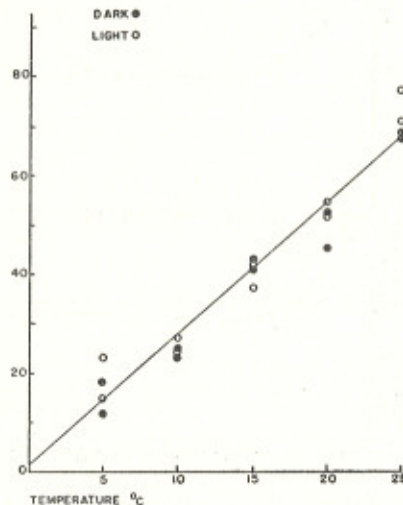

Figure 18. Oxygen consumption of *tonsa* in the light and in the dark plotted against temperature.

by a single 20 watt fluorescent tube, shielded by a parabolic reflector and suspended about 16 to 18 inches above the experimental vessels. In one experiment with *tonsa*, run at five different temperatures, only at 25° C were both light bottle values higher than the dark ones (Fig. 18). At the beginning and end of this experiment, aliquots were taken for determination of bacterial numbers. When the bacterial respiration component was deducted, the values for the light bottles were not different from the dark bottle values. In another experiment, designed expressly to test the effect of light on *clausi*, six replications were run in the dark and six in the light at 15° C. The mean respiratory rates were 0.0390 μ l per copepod and

hour in the light and 0.0368 μ l in the dark. The difference between the means was not statistically significant.

No experiments were performed with direct or diffuse sunlight. Klugh (1930) found that *clausi* was more resistant to ultraviolet radiation than *Calanus finmarchicus*. Since ultraviolet radiation would be quickly absorbed by the surface waters of Long Island Sound, the light conditions at a few feet below the surface are probably similar to the artificial conditions used in our experiments. Therefore, any lethal effect of light on the two species of *Acartia* must be of minor importance.

Effect of Temperature on Respiration. It has long been recognized that an increase in temperature will speed up a biological as well as a chemical reaction, but the basic laws of temperature coefficients, such as Berthelot's exponential formula and the Van't Hoff-Arrhenius law, designed to predict the behavior of chemical reactions, do not apply in many biological cases (Bělehrádek, 1930). Nevertheless, the simplified version of Van't Hoff's law,

$$(K_t + 10)/K_t = Q_{10} = 2 \text{ to } 3, \quad (1)$$

has had many biological applications. However, respiration data need not be referred to some coefficient of temperature such as Q_{10} to be useful to the ecologist.

Scholander, *et al.* (1953) used the term "MT curve" to describe oxygen uptake at a graded series of temperatures. Such data have been used previously to describe seasonal or climatic adaptation of cold-blooded animals. Wells (1935a, 1935b) found that *Fundulus parvipinnis* adjusted its metabolism to different environmental conditions. Fox and Wingfield (1937) compared two species of prawns from Swedish and British waters and found the respiratory curve of *Pandalus montagui* displaced upward in the colder environment. Arctic lamellibranchs had approximately the same respiratory rate at 5° C which was shown by Mediterranean forms at 15° C (Spärck, 1936). Essentially the same sort of climatic adaptation was recorded by Thorson (1936) for different generic pairs of bivalve mollusks in arctic and warmer waters. Scholander, *et al.* (1953), comparing the respiratory metabolism of poikilothermic animals from Point Barrow, Alaska and Barro Colorado, Canal Zone, found adaptation in aquatic forms such as fish and Crustacea.

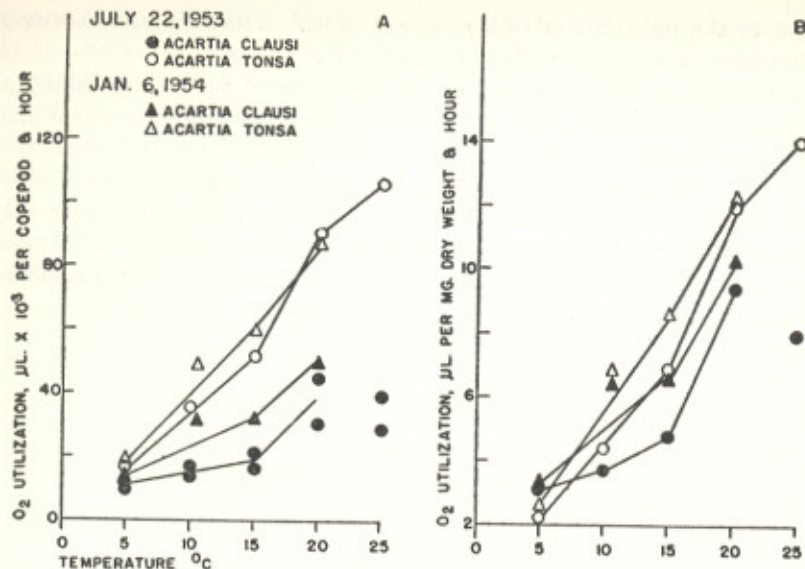

Figure 19. Respiratory rates on two different dates, one in summer and one in winter, plotted against temperature. A, Oxygen consumption in μl per copepod and hour; B, Oxygen consumption in μl per mg dry weight and hour.

Since the two species of *Acartia* in Long Island Sound have different seasonal and regional distributions, variations in oxygen consumption rates with temperature might prove useful to establish their environmental relationships. The amount of oxygen used in μl per copepod can be plotted directly with temperature (Fig. 19A), but since there is a significant difference in size between *clausi* and *tonsa*, a better comparison is obtained by converting oxygen values to common units (Fig. 19B). Milligrams dry weight was chosen because it was relatively easy to measure accurately and because it produced less distortion of the curves than any other measurement of volume or mass tried.

It is apparent in Figs. 19A and 19B that oxygen consumption was not necessarily related to temperature by a straight line, particularly in the case of *clausi*. Experiments from other times of the year indicated that the *tonsa* curve was nearly always linear while the *clausi* curve often showed an increasing Q_{10} between 15 and 20 $^{\circ}\text{C}$. This latter feature was more marked during the cooler months of the year than during the summer although Fig. 19 might appear to indicate

otherwise. However, the *clausi* curves for July 1954 did not show a significant trend towards nonlinearity. The significant decrease in respiratory rate of *clausi* on July 22, 1953 between 20 and 25 $^{\circ}\text{C}$ was almost certainly an injury response, suggesting that 25 $^{\circ}$ is near the lethal temperature for this species.

Previously, Marshall, *et al.* (1935) and Clarke and Bonnet (1939) had found that the respiratory curves of different stages of *Calanus finmarchicus* were nonlinear. Gauld and Raymond (1953) measured the increase in respiratory rate with temperature for *Temora longicornis*, *Acartia clausi*, and *Centropages hamatus*. *Temora* showed a distinct nonlinearity, with the respiratory rates nearly doubling between 10 and 20 $^{\circ}\text{C}$. Their curve for *clausi* was similar to those shown in Fig. 19, but it was displaced upward. The English Channel *clausi* appeared larger than those used in our experiments, but no correction for weight could be made for comparative purposes. The curve for *C. hamatus*, though based on incomplete data, resembled that given in Fig. 19 for *tonsa*; respiration appeared to increase linearly with temperature, although their curve for *Centropages* showed some tendency toward a decreasing Q_{10} around 20 $^{\circ}$.

The curves for the two species of *Acartia* also appear to be different in character. If each curve is extended to the left (Fig. 19A), the *clausi* curve would intersect the ordinate considerably above zero while the *tonsa* plot would pass near or through the origin. At low temperatures, the respiratory rate for *clausi* was actually higher than that for *tonsa* (Fig. 19B).

Zeuthen (1947) has pointed out that, at least under uniform conditions, the respiratory rate is a reflection of the animal's activity. Earlier experiments and observations on light responses showed that *tonsa* was definitely sluggish at low temperatures; the respiratory measurements confirm a low level of activity for *tonsa* when the temperature is low. In theory, the flat respiratory-temperature curve for *clausi* would indicate a considerable degree of eurythermy; that is, an increase or decrease in temperature over a considerable range would not seriously alter the metabolism of the animal. On the other hand, the curve for *tonsa* indicates a more stenothermal animal; *tonsa* cannot exert an appreciable degree of control over its body metabolism independent of temperature.

Seasonal Adaptation. Marshall, *et al.* (1935) found that oxygen utilization could vary as much as 0.2 ml per 1000 animals per hour

in *Calanus finmarchicus*. There appeared to be no relation to size, and they found no difference between winter and summer populations. However, when comparison of winter and summer populations of stage V *Calanus* was made on a weight basis, the winter population had a higher oxygen uptake at a given temperature than the heavier summer population (Riley, *et al.*, 1949).

Since both species of *Acartia* inhabit such a wide range of temperatures, seasonal adaptation in their respiratory metabolism might be expected. July 22 and January 6 (Fig. 19) represent the approximate temperature extremes at which the two species coexist. While the curves for *tonsa* on these two dates were similar, the slope of the January curve for *clausi* was probably significantly greater than that observed in July. Additional winter experiments confirmed this relationship although the data might suggest that by the end of winter the few *tonsa* remaining had made slight physiological adjustments so that their respiratory curve, if continued toward the left, would no longer pass through zero.

These two species appear somewhat similar in their relative environmental relationships to the common sand crab *Emerita talpoida* and the beach flea *Talorchestia megalophthalma* studied by Edwards and Irving (1943a, 1943b). Like *A. clausi*, the sand crab was active during the cold months and could readily adjust its metabolism to different temperature conditions; similar to *tonsa*, the beach flea, which hibernates in winter, could make no such alteration.

Further evidence of physiological adaptation by *clausi* was illustrated in heat tolerance experiments. Animals kept at 25° C on May 22, 1953 were largely moribund at the end of four hours; two months later the copepods still appeared active and healthy after eight hours at the same temperature even though the oxygen uptake values indicated that some injury may have occurred (Fig. 19).

Oxygen Consumption and Reproduction. During the summer of 1953 a progressive decrease in the respiration rate of *tonsa* was noted that could not be explained merely on the basis of decreasing size. When the oxygen consumption data from four experiments during July and August were converted to μl per milligram dry weight of copepods and a regression line was fitted to the points obtained, a progressive drop in slope from 0.59 on July 22 to 0.50 on August 19 was revealed (Fig. 20). Although transformation displaced the curve for July 29 somewhat higher than the remaining three, the slope

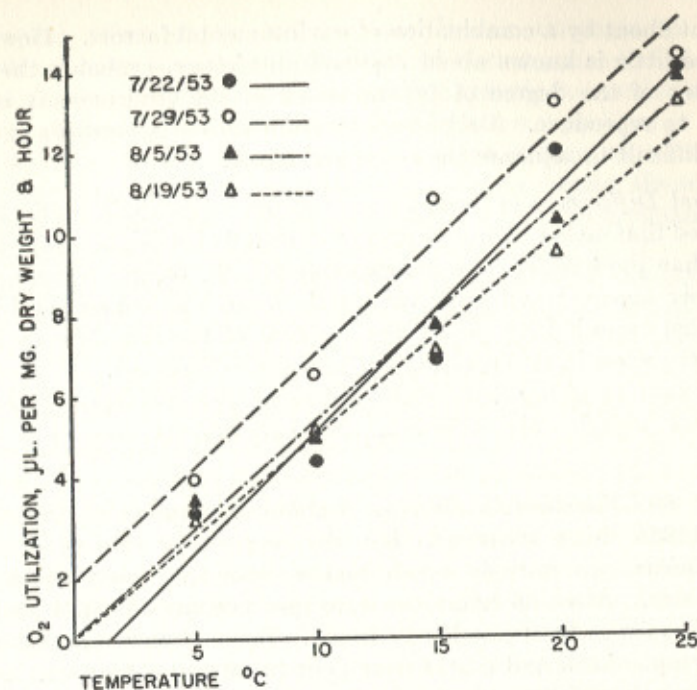

Figure 20. Regression lines for oxygen consumption of *tonsa* with temperature on four different dates during summer 1953.

was between the 0.59 recorded for July 22 and the 0.53 value for August 5.

Since the first experiment on July 22 was run during the period of most rapid growth of the *tonsa* population, the plankton tows during this period were examined to determine the relationship, if any, between breeding activity and respiration. An index was obtained by dividing the number of nauplii per cubic meter by the number of adult females which could have produced them. When this was done for the particular station from which the experimental animals were taken, the following index values were recorded: July 22 (slope = 0.59), index 48.0; July 29 (slope = 0.55), index 5.8; August 5 (slope = 0.53), index 3.8; August 11 (no respiration experiment), index 2.0; and August 19 (slope = 0.50), index 1.0.

It may be argued with good reason that the variation in oxygen uptake recorded for *clausi* and *tonsa* had nothing to do with reproduction but simply reflected a depression or acceleration of metabolism

brought about by a combination of environmental factors. However, since so little is known about copepod physiology, probably the best indicator of the degree of favorableness of the environment is the ability to reproduce. Under such circumstances, it becomes exceedingly difficult to separate the cause and effect.

Sexual Differences in Oxygen Consumption. Marshall, *et al.* (1935) observed that male *Calanus finmarchicus* usually had higher respiratory rates than the females. In our experiments, the oxygen consumption in μl per copepod and hour for female *tonsa* was somewhat higher than that recorded for males, but because of the size difference between the sexes in this species, this was not unexpected. Conversion of the data to $\mu\text{l}/\text{mg}$ dry weight indicated that the rates probably were not significantly different. No experiments were run with *clausi*.

Effect of Laboratory Conditions. Laboratory studies by Marshall, *et al.* (1935) have indicated that the respiratory rate of *Calanus finmarchicus* was initially much higher than that observed a few hours later. After 36 hours the rate had become constant and remained so for at least another 36 hours. Some of their animals were fed phytoplankton and others were kept in filtered sea water. Since there was no difference in respiratory metabolism between fed and nonfed specimens, these authors concluded that starvation was not the cause of the initial decline.

Two explanations have been put forward to account for this behavior. Keys (1930) found that several hours were required before the metabolism of certain fish became "normal" once they had been placed in the respiratory chamber. He believed that this length of time was necessary for recovery from the disturbance of setting up the experiment. In some of our own experiments (see Fig. 17), the initial respiratory rates were relatively higher than those obtained over a longer period. Certainly the process of capture and dilution must be disturbing to the organisms, but neither Key's fish nor our copepods required 36 hours for complete "recovery." Furthermore, if this initially high respiration was the result of capture and handling, it should be possible to "re-excite" the animals after they have been "conditioned"; however, this cannot be done. On the other hand, it seems possible that confining an actively swimming animal such as *Calanus* to small experimental vessels in the laboratory may have a

depressing effect on its metabolism. In our attempts to culture *Acartia* species, we found that most of the organisms died within a week's time, leaving a few hardier individuals to survive up to a month or more. Bacterial growth also becomes a problem in limited containers. At any rate, if "normal" respiratory rates attained after "conditioning" in the laboratory were really normal, the copepods should behave as they do in nature, that is, breed and maintain themselves in persistent culture.

On several occasions, the same collections of *tonsa* and *clausi* had to be used for more than one day's experimentation. Even though the animals were fed, their behavior on the second day was erratic and was frequently different from that observed the day before. Consequently, it seemed desirable to determine more about their behavior under laboratory conditions.

Samples taken from the Sound were diluted and placed in replicate containers (two quart mason jars) previously seasoned in sea water. The specimens in some of the mason jars received an aliquot of *Skeletonema costatum* sufficient to provide a cell concentration of about 16 million cells/l while those in the remaining jars were unfed. *S. costatum* is the dominant plankton diatom in the Sound during a large portion of the year, and examination of gut contents revealed that it is an important food source for both species of *Acartia* for at least part of the year. Raymond and Gross (1941) found it suitable as a culture food for *Calanus finmarchicus*. The high concentration of *S. costatum* was deemed necessary since the copepods were considerably more concentrated in these jars than they would have been in nature.

After an overnight recuperation period, the respiratory rates at 15° C of both fed and unfed copepods were measured every 24 hours for six days (Fig. 21). During the first two days of the experiment, *clausi* outnumbered *tonsa* in the vessels to such an extent that it was not practical to run comparative experiments, but by the third day, sufficient *clausi* had been removed so that *tonsa* could be isolated. The *clausi* curve shows clearly that a sharp drop in oxygen utilization occurred between the first and second days in both fed and nonfed samples. By the third day, unlike the results of Marshall, *et al.*, a significant difference between the fed and starved animals was evident. Following the initial decrease (which probably occurred for *tonsa* as well as *clausi*), the copepods fed *S. costatum* maintained an

essentially uniform respiratory rate, while those that went hungry showed a progressively declining rate. The last observation for starved *tonsa* was not completely consistent with the other observations; by this time so few animals remained that only one replication was possible. Daily examination of the gut contents showed that, throughout the six days of the experiment, the guts of the fed animals were clearly packed with green cell remains while those of the starved copepods were quite colorless.

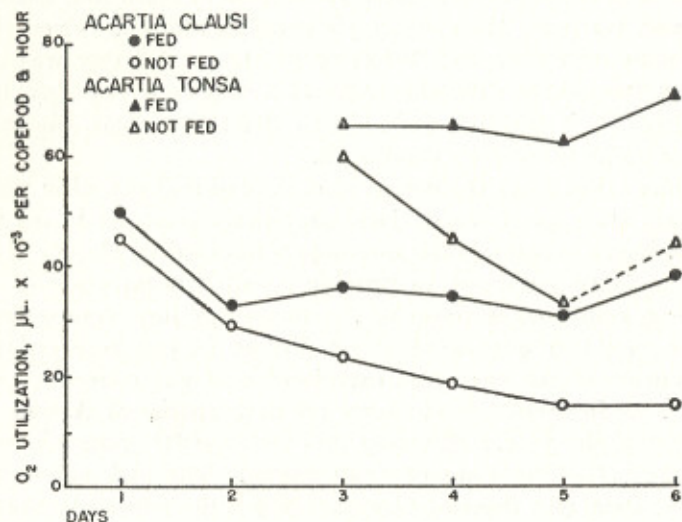

Figure 21. Comparison of respiratory rates of both species at 15° C when starved and when fed *Skeletonema costatum*.

To be sure, this experiment does not prove that all of the respiratory discrepancies noted in the literature result from the inadequacies of the laboratory. However, the evidence does suggest that the further removed an animal is from its natural environment the less likely it will be to exhibit behavior characteristic of that environment.

Relationship between Copepods and Available Food

The biological as well as the physical environment must be important in governing copepod distribution. Qualitative studies by Lebour (1922) have indicated that different species of marine copepods have quite different eating habits. Harvey (1937) showed that *Calanus*

finmarchicus selected the larger diatom *Ditylum brightwellii* in preference to the smaller *Lauderia borealis*. According to Fuller (1937), *Calanus finmarchicus* could not capture enough *Nitzschia closterium* to meet its food requirements, but Gauld (1951) obtained quite high grazing rates when a species of *Chlamydomonas* only slightly larger than *Nitzschia* was used as a food source. Aside from the study by Riley, *et al.* (1949), no truly quantitative work has been undertaken to determine the inter-relationships of the zooplankton and its food supply. Therefore a series of experiments was initiated to determine how the biological environment might affect the distribution of *clausi* and *tonsa* and how the physical factors might affect their ability to survive in this environment.

Methods. In the sea, nonmotile phytoplankton such as the diatoms are maintained in the upper waters principally by vertical turbulence, but in the laboratory, phytoplankton quickly settle to the bottom of a vessel unless some type of artificial turbulence is supplied. In previous grazing experiments, conventional stirring or shaking techniques injured the animals or at least inhibited their activity. Figs. 22, 23, and 24 illustrate the structural details of the apparatus used in our experiments. The same constant temperature baths used

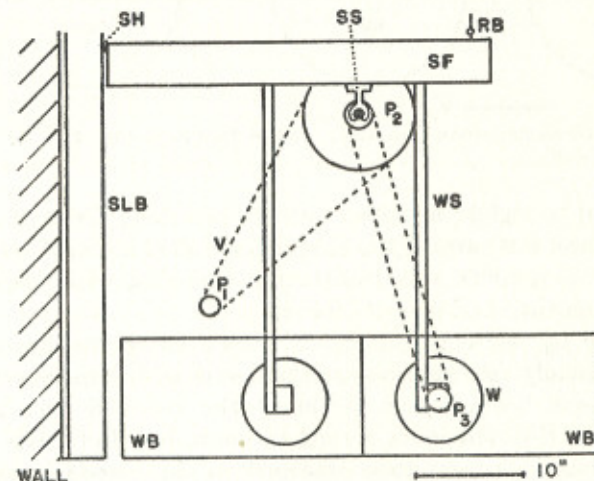

Figure 22. Grazing apparatus, end view. P₁ = 2" pulley. P₂ = 10" pulley. P₃ = 2½" pulley. RB = Ring belt for attachment to overhead support. SF = Supporting frame. SH = Strap hinge. SLB = Steel L beam. SS = Brass bearing line shaft hanger. V = ½" V belt. W = Wheel. WB = Water bath. WS = Wheel support.

for the respiration experiments were also used for the grazing studies (Figs. 22, 23). Five "wheels" were so suspended from an overhead frame that they could be rotated entirely beneath the surface of each water bath. Power from a friction drive Warburg shaker motor was supplied by a system of pulleys which connected the power source to a main shaft and thence to each wheel (Fig. 22). Pulley diameters were selected so that each wheel made about eight revolutions per minute. Each wheel was constructed so that eight experimental

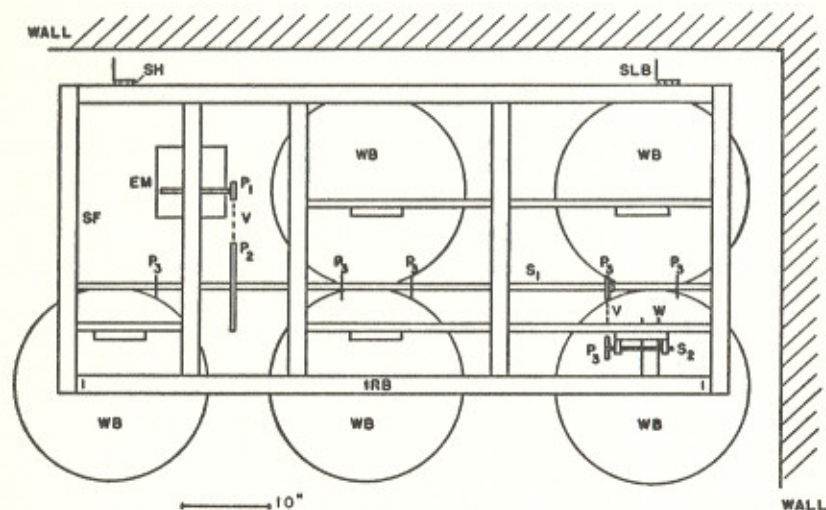

Figure 23. Grazing apparatus, top view. EM = Electric motor. S_1 = $\frac{3}{4}$ " line shaft. S_2 = $\frac{1}{2}$ " brass shaft.

vessels could be rigidly attached near its periphery (Fig. 24). Thus, when the wheel was turning the direction of fall of a suspended particle in response to gravity was continually changing with respect to a fixed point on the outside of the vessel.

In setting up the experiments, a known concentration of phytoplankton, usually *Skeletonema costatum*, was added to several 35 ml glass stoppered bottles; part of the bottles received from 25 to 50 copepods and the remainder served as controls. Both experimental and control bottles were then attached to the wheels in the water baths. At the end of a run, the entire contents of each bottle were preserved in formalin, allowed to settle and concentrated by decanting. Counts were made with a Sedgewick-Rafter counting chamber and

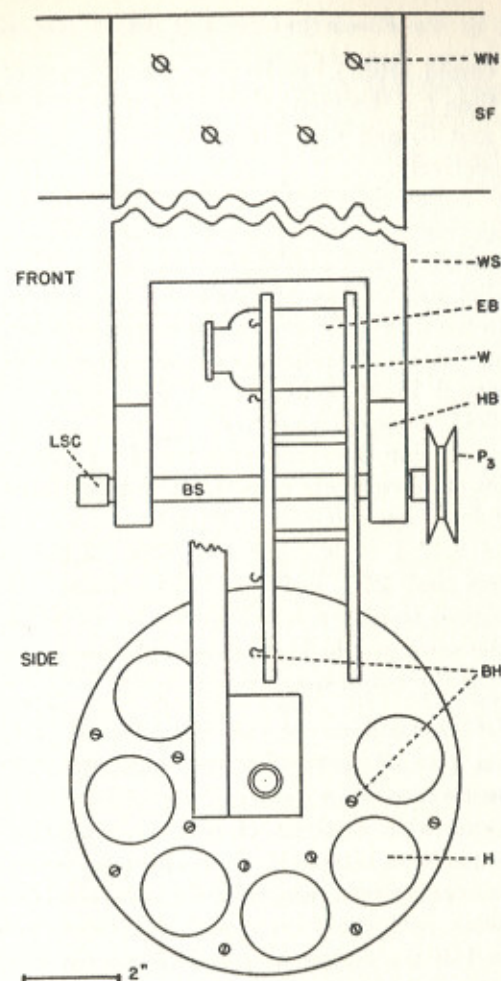

Figure 24. Grazing apparatus, detail of wheel and support. BH = Brass cuphooks. BS = $\frac{1}{2}$ " brass shaft. EB = Experimental bottle. H = Hole; experimental bottle inserted here. HB = Hardwood bearing. LSC = Line shaft collar. W = Wheel, $\frac{1}{4}$ " marine plywood. WN = Wing nut. WS = Wheel support, $\frac{3}{4}$ " pine.

a Spencer microscope equipped with a 16 mm apochromatic objective and 15x compensating oculars. The amount of water filtered by the copepods was determined from the difference in cell counts between experimental bottles and controls, using the equation

$$F = v (\ln C_o - \ln C_i)/t, \quad (2)$$

modified from Gauld (1951), where F is the amount of water swept free of food in time t , v the volume of water per animal in the experimental bottle, and C_i and C_o the experimental and control cell concentrations respectively.

The error in Sedgewick-Rafter counts was assessed as follows. As a general working criterion, at least 100 organisms were counted; with this standard, it was found that 30 random fields in linear transects, one parallel to the long dimension of the cell and two others perpendicular to the first, gave the smallest standard error. An effort was made to concentrate the original sample so that at least 100 organisms were observed in 30 fields, but when this was not possible, additional ten-field transects were counted until 100 organisms were found. On one occasion the standard error of log difference was computed for a series of 10 replicate counts, the log difference being 1.1408 with a standard deviation of 0.0966. With these data it was calculated that an error of 8.47% or less occurred 68% of the time and that the error was less than 25% in 99% of the counts. Thus, if experiments were designed to give a log difference of over 1.0, the order of magnitude of the error would be in good agreement with that previously obtained for the respiratory experiments.

Effect of Cell Concentrations on Grazing. Gauld (1951) has shown that the grazing rate of three different copepods was independent of cell concentrations over a range of an order of magnitude. In our study, no extensive analysis of cell concentration and grazing rates was made except to establish criteria for experimental procedure. When experiments covering a range of cell concentrations of two orders of magnitude were performed on *clausi* and *tonsa*, a lower grazing rate was obtained at the highest phytoplankton concentration. This concentration, about the midrange for Gauld's experiments, was only slightly greater than the spring flowering peak in Long Island Sound. Much of the previous work was done with higher cell concentrations than those normally found in nature; however, the three concentrations employed in our experiments were near the minimum, the average, and the maximum phytoplankton concentrations recorded in the Sound. It is not clear whether the low grazing rate of *clausi* and *tonsa* at spring flowering concentrations was due to satiation or simply to mechanical inability to handle so much food.

Effect of Copepod Waste Products on the Growth of Phytoplankton. Lucas (1947) has pointed out that "external metabolites" in the water can have profound effects on certain marine organisms. Since living copepods presumably excrete waste products continuously as organic compounds and inorganic ions which might be beneficial or inhibitory to the growth of phytoplankton, it seemed advisable to determine whether or not control and experimental vessels represent the same environment in so far as phytoplankton growth requirements were concerned. Replicate bottles were prepared to the same initial concentration of phytoplankton with aged Berkefeld filtered sea water and with water previously inhabited by living copepods. Both sets of bottles were then subjected to normal experimental procedure, and numbers were estimated in the usual way. For temperatures below 15° C, the normal Berkefeld control appeared to be adequate, but at higher temperatures the results were inconclusive. In one experiment no difference was detected between the two sets of bottles at 25°, whereas in another, the copepod water encouraged a higher growth rate at 15° but seemed to suppress growth at 20°. Since there was no pronounced or systematic effect on phytoplankton growth metabolism, the work was not pursued further.

Effect of Culture Age on Grazing Rates. In our preliminary experiments, considerable variation was noted in the amount of water filtered by copepods under supposedly similar conditions. Ryther (1954) found that senescent cultures of *Chlorella vulgaris*, *Scenedesmus quadricauda*, and *Navicula pelliculosa* gave lower grazing rates for *Daphnia magna* than log phase cultures. Ryther's observations suggested that the physiological state of the *Skeletonema costatum* cultures employed by us might explain some of the variation noted in grazing rates.

Food cultures of *S. costatum* were started on December 5, 8, 11, and 13, using the same medium and the same strain of cells as inocula on each date. On December 17, the grazing rate of *tonsa* was measured at three different temperatures, using grazing cultures made up from the different stock cultures. Thus the grazing cultures ranged in age from four to 12 days. The cell concentrations were adjusted so that all experimental and control bottles contained approximately the same initial number of cells per liter. The six day old culture, clearly in log phase (see Fig. 25B), gave a significantly higher grazing rate at all temperatures than the 12 day culture, and it was also

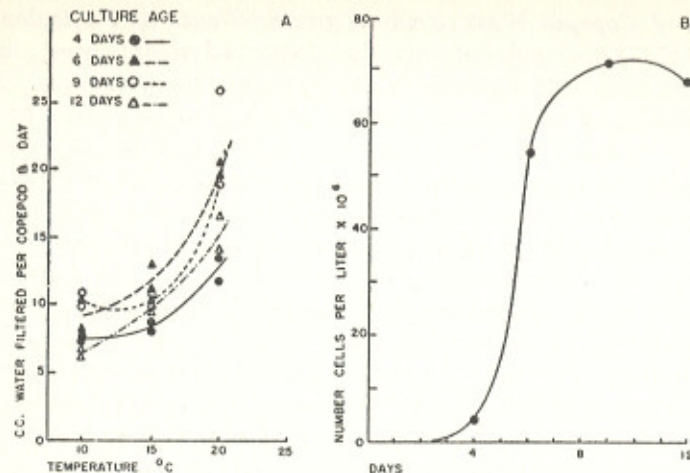

Figure 25. A, Grazing rates of *tonsa* fed *Skeletonema costatum* culture of different ages. B, Hypothetical growth curve for *Skeletonema costatum* based on cell concentrations in cultures of four different ages.

superior in most cases to the four and nine day cultures (Fig. 25A). Thus the experiment suggests that culture age is a primary concern in determining the feeding rates of zooplankton.

Light and Grazing Rates. Field observations by Wimpenny (1938) suggested that zooplankton feed more at night than during the day. Laboratory studies by Fuller (1937) and Gauld (1951) tended to confirm the presence of a diurnal feeding rhythm. However, when Gauld (1953) re-examined the problem, he found that 80–100% of the *Calanus finmarchicus* taken from the surface waters had been actively feeding regardless of the time of day. Although laboratory studies indicated long periods of low feeding activity, these could not be correlated with amount of light. From these studies he concluded that there is no diurnal rhythm in grazing of copepods distinct from their diurnal rhythm of vertical migration. More food is consumed at night because the copepods tend to congregate in the upper waters where food is more available, but apparently grazing is more or less continuous.

In a preliminary examination of the effect of light, no significant differences in grazing rates were detected in either light or dark. Nor did light have a differential effect on phytoplankton growth rates over the normal experimental period.

Sexual Differences in Grazing Rates. Raymont and Gross (1941) fed male and female *Calanus finmarchicus* different cultures of marine phytoplankton and recorded the number of fecal pellets produced. In almost all of their experiments, more fecal pellets were produced by the females. For instance, with the centric diatom *Ditylum brightwellii*, 25 males produced 540 pellets in 68 hours and consumed an average of 31 cells/cc, while the same number of females produced 4000 pellets during the same period and consumed 476 cells.

In our first experiment, run at 20° C with *tonsa*, males filtered an average of 413 ml water per mg dry weight and day while the females filtered 894 ml, or more than twice as much. When these results are compared with the oxygen consumed, we find that the males actually expended more energy in filtering 413 ml of water than the females did in filtering twice that amount. In another experiment, the average female *tonsa* removed food from 25.1 ml water in a day while the males filtered only 9.12 ml.

Among lower animals the males are often smaller and weaker than the females, and it is possible that male copepods are subservient to the females. Once the spermatophore is attached to the genital segment of the female his function is completed, whereas the female must survive long enough to produce sufficient eggs to insure survival of the species. If the adult male lived only briefly, there would be less competition for food as the progeny developed.

Effect of Temperature on Grazing. During fall and winter of 1953–54 and in early summer 1954, comparative experiments were run to ascertain the effects of temperature on grazing. Fig. 26 represents grazing curves derived from two winter experiments in 1954. The rate for both *clausi* and *tonsa* was essentially linear with respect to temperature on January 6; this linear relation between temperature and grazing was characteristic of results obtained throughout the fall. At lower temperatures the *clausi* grazing rate was significantly higher than that for *tonsa*, with the inverse situation at higher temperatures. However, on February 2, grazing rates for both species increased rapidly with temperature up to 15° C and then declined between 15 and 20°. A grazing curve for *clausi* obtained January 26 was just intermediate in shape between these two; that is, grazing rates rose sharply with temperature up to 15° but merely leveled off at 20° instead of declining as on February 2. There were not enough *tonsa* in the tows to run more than a token experiment on

January 26, so their behavior is mere supposition. Nonetheless, this series of experiments suggests the occurrence of temperature conditioning.

Water temperatures throughout the fall and early winter were several degrees higher in 1953 than in 1952, but about the first of January 1954 a series of cold spells caused a sharp drop in temperature over a period of two weeks, after which temperatures remained around 2° C through the rest of January and February. Thus the animals

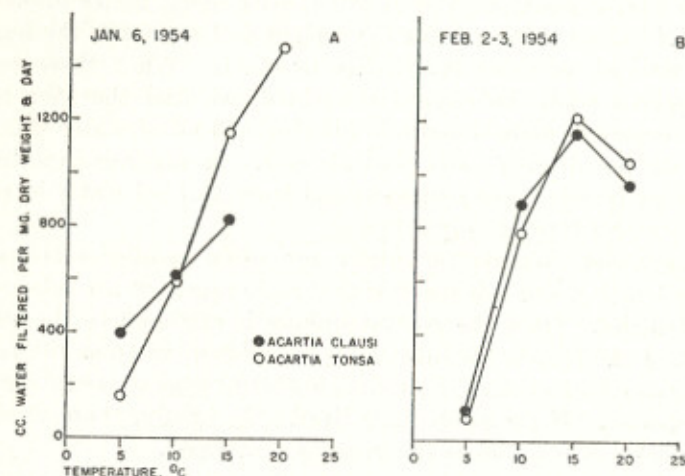

Figure 26. Grazing rates for adults plotted with temperature. A, January 6, 1954; B, February 2-3, 1954.

used on January 6 had a previous temperature history about 4-6° higher than those used on February 2.

If the amount of oxygen consumed by an animal in a given period of time is roughly proportional to the amount of organic matter oxidized, it should be possible to compute the theoretical food requirements of each species and compare it with the actual amount of food present in the water. However, before this can be done, certain assumptions are necessary. First, since our understanding of the physiology of copepods is limited, for the sake of simplicity let us assume a carbohydrate metabolism with glucose as the substance oxidized. Second, let us assume that the organic substance of the copepod is 50% carbon. Thus, $\text{ml O}_2 \text{ consumed} \times 1.4 \times 0.375 = \text{mg C oxidized}$, where 1.4 is the density of oxygen and 0.375 the carbon/

oxygen ratio in the glucose equation. The value for carbon obtained may be multiplied by 100/50 to give the results in terms of organic matter oxidized.

If the water temperature in the Sound is known, oxygen consumption rates interpolated from laboratory curves can be used to compute carbon requirements for any given date, and grazing curves can be used to determine the amount of organic matter that is necessary to fulfill this requirement. When the theoretical concentration of plant material (in μg chlorophyll per liter) which is required to maintain the population in a steady state is plotted for both species with the average winter concentration of chlorophyll observed in the Sound, it is clear that *tonsa* was not able to meet its metabolic needs during most of December and January (Fig. 27). To be sure, *clausi* also may

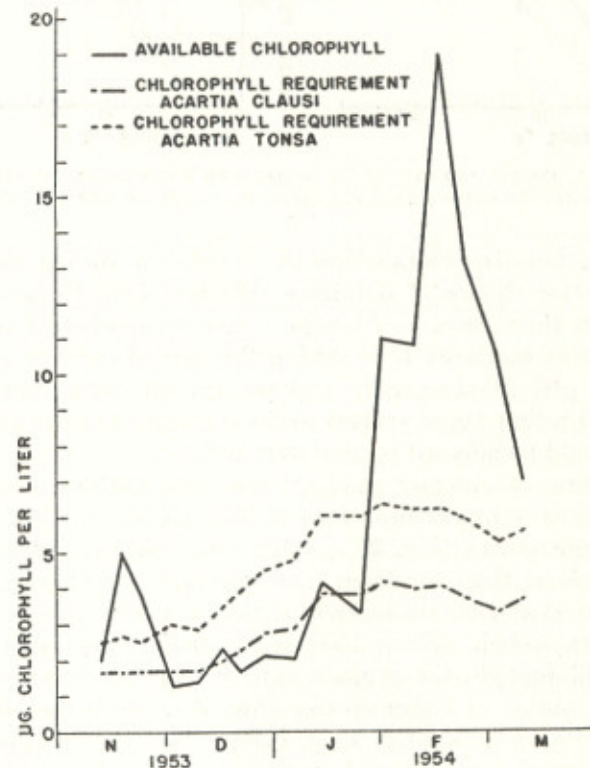

Figure 27. Chlorophyll requirements, in μg per liter, of adults plotted with available chlorophyll; winter, 1953-1954.

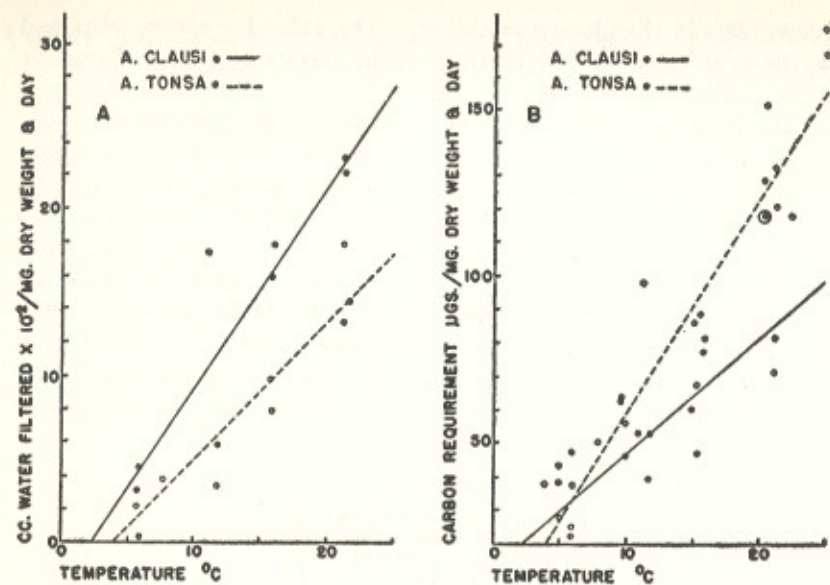

Figure 28. A, Grazing rates for adults plotted with temperature; summer 1954. B, Carbon requirements for adults plotted with temperature; summer 1953 and 1954.

have had a negative metabolism at times, but during the winter it had a better chance of obtaining sufficient food for growth and reproduction than *tonsa*. Although the total number of organisms estimated from scattered tows during this period did not agree perfectly with periods of scarcity and plenty, the data appear to be reasonable if a time lag of several weeks is assumed before population numbers would be affected by variation in food.

Examination of summer grazing rates and carbon requirements plotted against temperature showed that *clausi* was still favored by high temperatures (Fig. 28). Since corrected grazing rates were higher for *clausi* than for *tonsa* and corrected carbon requirements lower, *clausi* should obtain more food than *tonsa* for a given amount of energy expended. When food requirements were plotted with available chlorophyll, the organic matter was sufficient to support a large population of either species (Fig. 29). Nonetheless, if both species ate the same kind of food, competition should favor *clausi*.

All of the grazing rates used here were determined with the diatom *Skeletonema costatum*, primarily a winter and spring form in Long

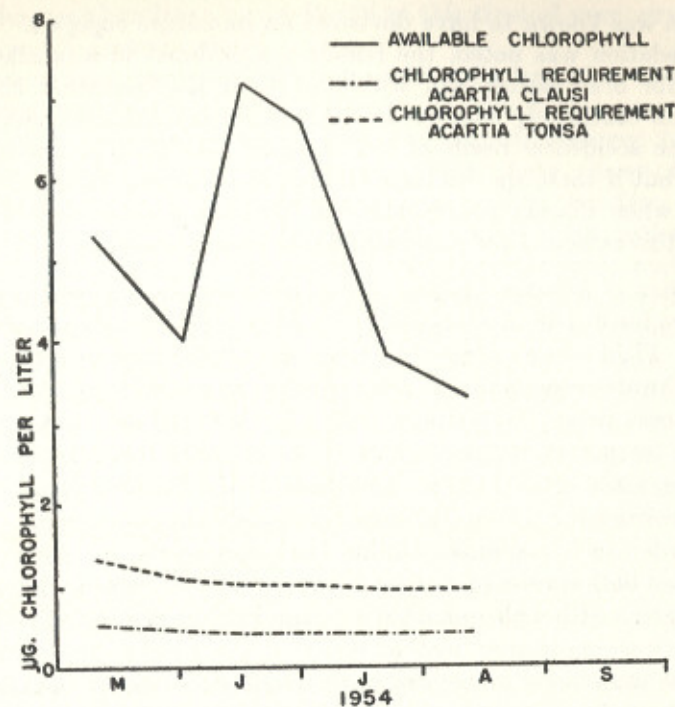

Figure 29. Chlorophyll requirements, in µg per liter, of adults plotted with available chlorophyll; summer 1954.

Island Sound, but during the summer months the diatom population was generally low compared with the flagellate population. Although *tonsa* grazing rates might have been high enough had a summer phytoplankton species been used to account for this discrepancy, it does not seem likely on the basis of available information. In the first place, corrected grazing rates for populations of both species were larger in summer than in winter, except at the lowest temperature, but the amount of increase was greater for *clausi*. Secondly, when the copepods were fed natural summer phytoplankton, *clausi* still had a higher grazing rate than *tonsa*, although neither species fed as well on phytoplankton dominated by flagellates as it did on *S. costatum*.

It is possible that *tonsa* utilized another source of food that was unavailable to *clausi*, for on two occasions a *tonsa* female in laboratory

cultures was known to have devoured an immature copepod. When this predation was noted, the female was isolated in a smaller container for observation, and within an hour the immature copepod had been completely consumed. This predatory activity could have been the accidental result of overcrowded conditions in the culture vessel, but if these species have to depend on animal food to a large extent when diatom populations are low, the greater size of *tonsa* during this season of the year should give it an advantage.

Question of Selective Feeding. Previous mention has been made of selective feeding in the laboratory by *Calanus finmarchicus* (Harvey, 1937). Field observations by Lowndes (1935) demonstrated that the freshwater copepod *Diatomus gracilis* can select its food in nature. In a recent paper, Hutchinson (1951) has pointed out that, particularly in temporary waters, two or more species of copepods of widely differing sizes often coexist; presumably the larger species would not compete with the smaller ones for exactly the same food.

In order to investigate possible food preferences in nature, individuals of both species of *Acartia* were cleared in creosote and mounted in balsam. Although quantitative examination of the type of food present was impossible because many of the smaller phytoplankton elements were badly macerated in the feeding and digestive processes, some of the larger forms could be identified and their numbers were roughly estimated.

During winter, both species appeared to be feeding primarily on two species of *Thalassiosira* and on *Thalassionema nitzschioides*, a colonial pennate diatom. At the height of the spring flowering, the guts of both *clausi* and *tonsa* were packed with *Skeletonema costatum* as well. In addition to identifiable forms, the guts always contained a considerable quantity of greenish material of unknown origin. In summer there was less food in their intestines and a higher percentage of this was unidentifiable. The most common recognizable form at this time of year was the small *Coscinodiscus radiatus*, but fragments of a larger species of *Coscinodiscus* were found occasionally, more frequently in *tonsa*. However, the major difference in gut contents during summer was the frequent occurrence in *tonsa* of a sizable transparent form of indefinite shape; while this object was not positively identified as a plant cell, its size was about the same as that of a naked dinoflagellate of the genus *Prorocentrum* found in

considerable abundance in the Sound at this time of year; practically never was it found in *clausi*.

If *clausi* and *tonsa* are behaving as filter feeders, then the size of the apertures made by the fine hairs on the feeding appendages should determine the minimum size of a particle removed from the water. Lowndes (1935) and Cannon (1928) have shown that, in several species of calanoid copepods, the second maxillae do not participate actively in the food-getting processes but rather serve as a filter or sieve through which a feeding current is maintained by the activities of certain other appendages. Although the second maxillae also serve as the principal filter among members of the genus *Acartia*, they are used actively for "seining" rather than as an immobile net on which food particles are collected. Each second maxilla of the *Acartia* has 12 long curved spines pinnate with short bristles 10–20 μ in length. The maxillae are worked in unison; first the spines are spread apart to form an open basket-like structure, and then they are quickly drawn together much as a fisherman might use a drop net. Thus the size of the apertures varies somewhat depending on whether the "seine" is open or closed, but the minimum size still is determined by the distance between adjacent pinnate bristles.

In the case of *tonsa*, this distance, estimated as 7–8 μ , was practically the same in summer and winter. On the other hand, for *clausi* a considerable seasonal variation was noted, the bristles in summer averaging only 4–5 μ apart, in winter 9–10 μ . Although a sizable percentage of the flagellates would slip through the apertures of either species, *clausi* should be better able to catch the smaller forms present in summer than *tonsa*.

Several grazing experiments which were run to determine if the copepods showed any differences in choice of food in the laboratory gave negative results whether natural populations of phytoplankton or mixed laboratory cultures were used. During the spring flowering, when a natural population dominated by *Skeletonema costatum* and *Thalassiosira nordenskiöldii* was used for grazing experiments, neither species of copepod demonstrated selectivity. However, when laboratory cultures of *S. costatum* were compared with laboratory cultures of *Nitzschia closterium*, both copepods showed a distinct preference for the former. Nevertheless, there was no differential selectivity; that is, the ratio of the filtering rate with *S. costatum* as a food source

to that for *N. closterium* was about the same in the case of both *clausi* and *tonsa*. The most interesting feature of this experiment was the result obtained when *clausi* and *tonsa* were fed a mixed culture containing equal numbers of *S. costatum* and *N. closterium*, adjusted to give the same approximate total concentration used with either culture alone. In this case, the grazing rates determined from the consumption of *N. closterium* in the mixed culture were about the same as those determined from *N. closterium* alone, but the grazing rate determined from *S. costatum* in the mixed culture was significantly lower statistically than the rate from *S. costatum* alone. The low numbers of *N. closterium* eaten by *clausi* and *tonsa* cannot be explained entirely on the supposition that it is too small (diameter, 3-4 μ) to be captured by the feeding mechanism; rather, it appears to be so unsuitable as food that feeding processes are suppressed.³

In another experiment, with summer populations of phytoplankton, the dominant identifiable forms were the dinoflagellates *Ceratium lineatum*, *Dinophysis acuminata*, and *Prorocentrum scutellum* (?). While the individual grazing rates on these dinoflagellates were too low for statistical treatment, the data suggest that *tonsa* might prefer *C. lineatum* to *D. acuminata* and that *clausi* might prefer *D. acuminata* to the larger *C. lineatum*.

GENERAL DISCUSSION

The descriptive data for Long Island Sound have shown that the distribution of each species of *Acartia* is limited seasonally, as was true also in Tisbury Great Pond (Deevey, 1948). Although Deevey's data suggested rigid temperature control, our study seems to indicate that at least the adults of both species can survive the temperature extremes found in the Sound.

In Tisbury Great Pond, a temperature of 22 to 24° C appeared to be lethal to *clausi*. However, in Long Island Sound *clausi* was largely gone from the water before the average temperature reached

³ A recent paper by Hendey (1954) has cast considerable doubt on the identity of certain *Nitzschia closterium* cultures. The form used in these experiments and in the majority of other feeding studies was probably the *Nitzschia closterium* (Ehrenberg) Wm. Smith forma *minutissima* which was isolated at Plymouth by Allen and Nelson (1910); this form always contains a few triradiate cells. Hendey believes that this organism is *Phaeodactylum tricornatum* Bohlin rather than *N. closterium*. There is good evidence to suggest that it is not even a diatom.

20°. Since there is usually a moderate thermocline at this time of year, the temperature of the deeper waters remains below 22° well into August, long after *clausi* has completely disappeared. Moreover, laboratory experiments have shown that summer populations of adult *clausi* are well acclimatized to temperatures around 20°, but by the time Sound temperatures have risen to this level the balance has swung toward *tonsa*. Although the experimental data do not rule out completely the lethal effect of high temperature as a possible limit to *clausi* production, certainly no temperature was recorded which was low enough to cause the abrupt elimination of either species.

It has been shown that the adult *clausi* was definitely the more efficient organism at low temperatures. On the other hand, *tonsa*, the summer form, was still outstripped by *clausi* under laboratory conditions approximating the summer environment. Although both species should be able to meet their energetic needs on the basis of available carbon, *clausi* should dominate in summer as well as in winter unless there is some selection of food favoring *tonsa*. The larger *tonsa* might be more successful with larger food organisms, but evidence suggests that a high percentage of the available organic matter in summer is in the form of small flagellates. The food studies performed on the adult organisms do not adequately explain the absence of *clausi* and dominance of *tonsa* in summer, and yet another explanation must be sought.

Figs. 7 and 8 show that the developmental stages of *clausi* began to disappear somewhat earlier than the adults. Thus the unfavorable trend in the environment must have been operating primarily against the young stages. The nauplii and copepodids may have a lower temperature tolerance than the adults, but the gradual decline in numbers of *clausi* and the steady increase in young *tonsa* suggest a more subtle temperature control. Final resolution of this problem must await the development of a more sensitive experimental procedure and a culture method.

Even if temperature is ruled out as the direct cause of seasonal fluctuations in species composition, its influence must be considerable. In laboratory experiments, temperature change had a profound effect on the organism in several inter-related ways; moreover, the degree of influence was greater on one species than it was on the other, which would imply certain differences in metabolic control. Tem-

perature also affected the activity of the animals and thus influenced such important processes as food acquisition. Therefore, it appears that temperature may act to control the distribution of *tonsa* and *clausi* indirectly, first making the environment slightly more favorable for one species and then for the other. From available information on food and vertical distribution, the ecological niches of these two species must at least overlap. In the light of classical theory, these organisms should be in competition.

The best known mathematical description of population growth is probably the logistic of Pearl and Reed (1920), which may be written

$$dN/dt = bN(K - N)/K, \quad (3)$$

where K is the population size at saturation density, N the population size at any given time t , and b a growth coefficient. This equation was rewritten by Gause (1934) to express the inter-relationship between two species inhabiting the same environment,

$$dN_1/dt = b_1N_1(K_1 - N_1 - \alpha N_2)/K_1, \quad (4)$$

$$dN_2/dt = b_2N_2(K_2 - N_2 - \beta N_1)/K_2, \quad (5)$$

where the subscripts $_1$ and $_2$ distinguish the two species and where the terms αN_2 and βN_1 describe the degree of influence each organism has on the other.⁴

From these equations it is possible to predict that one of three things may happen in a competitive system involving two species (Gause and Witt, 1935). First, if $\alpha > K_1/K_2$ and $\beta > K_2/K_1$, then the species which is initially dominant would survive while the sub-

⁴ Recently Andrewartha and Birch (1953) have criticized this classical approach to population problems, but a fallacy in their argument should be mentioned. They state that K is conceived ". . . as the maximum or saturation density for a particular place and the particular circumstances in which the population is living." According to G. E. Hutchinson (personal communication), K is conceived only as a saturation density, but there is no reason why K may not be exceeded under artificial or unusual conditions; therefore, K cannot be a maximum as well as a saturation density. If the biologist prefers, he may start with a laboratory population with N higher than K , in which case it is assumed that the population will decline to the level K . The fact that the original mathematical treatment of Gause provides for such an assumption is certainly a point in its favor. Furthermore, no mathematical interpretation of biological phenomena is without some criticism, but until a better description of the problem is put forward, a theory with such wide application (see Riley, 1952) should not be discarded on a technicality.

dominant would be eliminated. Such a case might involve some equally strong mutual depressant, such as an antibiotic, but there is no evidence in our investigation for such a direct biotic effect of one species on the other. Second, if the ecological niches coincide precisely and if the uniform environment favors one species (*i.e.*, $\alpha < K_1/K_2$ and $\beta > K_2/K_1$), then the degree of influence of the better adapted species on the other would be sufficient to bring about the elimination of the competitor. Finally, if the ecological niches do not coincide precisely, some interaction may occur, but each species can retreat outside the zone of influence of the other so that coexistence is possible; in this interpretation $\alpha < K_1/K_2$ and $\beta < K_2/K_1$.

In setting up these equations, conditions were considered to be constant, α and β as well, but obviously no such situation exists in nature. Consider what would happen if some external variable, such as temperature, brings about a differential change in the values of α and β ; the curves of the struggle for existence would change, and at some critical level the change could be qualitative, resulting essentially in a redefinition of the niche of each species. Furthermore, if the variable were seasonally controlled so that a rhythmic pattern was established, the competitive system would show rhythmic variation as well. First one species would be favored and then the other, as was the case in Long Island Sound.

In recapitulation, during late spring and early summer, when the most pronounced temperature gradient existed, the ecological niches of the two species showed the least amount of overlap. As the water warmed in summer, the environment became essentially homogeneous, leading to competition within a single niche. From the available information it was inferred that competition was strongest between the developmental stages of the two species. As the water cooled in the fall, the niches appeared to separate again. Whatever interaction occurred, it must have taken place between the younger stages, as in summer. The later stages of *tonsa* became relatively dormant, and since winter *tonsa* contained considerable amounts of stored fatty reserve, they scarcely needed to enter into competition with the favored *clausi*. During the spring flowering period, *clausi* multiplied rapidly; this fact, together with the phytoplankton dearth just after the flowering, should result in strong competition for food. By this time, the water had warmed enough to suspend dormancy during a period when the food reserves of *tonsa* were at a low point.

Once again the niches coincided and *clausi* was successful. Only once during the year were there simultaneous increases of both species. This exception, during and just after the spring flowering, may actually lend support to the theory, for it is probable that competition for food was minimal at this time.

Seasonal Distribution of the *Acartia* in Other Areas

The information accumulated in this study should be of use in the interpretation of previous observations even in areas quite far removed geographically from Long Island Sound.

The coastal waters off southern California, where both *clausi* and *tonsa* occur in fair abundance, were examined by Esterly (1928) by means of surface tows made twice daily for over two years from Scripps Pier at La Jolla. In both years, *clausi* attained maximum numbers in March, decreased through the spring months, and was essentially absent from these waters from the end of June until September. Throughout the fall and winter, a more or less steady increase occurred until the spring maximum was attained once more in March. *A. tonsa*, on the other hand, attained peak numbers in July or August and then declined gradually after the first of September to a winter minimum in February. In March the population underwent some resurgence, only to decline again to a June minimum in 1917 and to an early July minimum in 1918. The seasonal picture, therefore, is not unlike that observed in the Sound, except that *tonsa* was never completely absent from the California waters.

The seasonal temperature variation for these waters was about 8.5° C. Unfortunately Esterly averaged the temperatures for the two years, so that precise comparison of our data with his is not possible; however, maximum temperatures of about 21.5° occurred in late August and minimum temperatures around 13° occurred in late January and early February. The salinity was somewhat higher than that in the Sound, the spring minimum being about 33.30‰ and the fall maximum 33.90. The phytoplankton abundance was not determined by Esterly, but studies by Allen (1927a, 1927b) of the waters off La Jolla during other years indicated diatom peaks in March and April, perhaps another in July, and a fall maximum in November.

Interpretation of the *clausi* cycle off California is relatively simple because of its similarity to that in local waters. The preference for

cool waters was unmistakable and the maximum numbers observed in March corresponded reasonably well with the postulated spring diatom flowering. During most of the year the greater number of *clausi* were taken in night tows, but in June and July there was little difference between night and day catches. Thus the evidence is not contradictory to the supposition that a thermocline may restrict the normal diurnal migration of *clausi* after surface waters have warmed to some critical temperature. In the fall, *clausi* numbers increased quite rapidly, with a subsidiary December peak recorded in the second year of the survey. This might be correlated with a fall diatom bloom in November.

Likewise, the *tonsa* cycle was similar to that observed in the Sound when it is considered that conditions of existence were less extreme in California waters. The summer maximum in both places was certainly produced under similar conditions. No information is available concerning the distribution of young stages in winter, but comparison of night and day tows strongly suggests a degree of dormancy. The water temperatures at La Jolla in winter were not nearly so low as those recorded in the Sound, but, since seasonal acclimatization appears to be present in Sound *Acartia* populations, a different level of climatic adjustment to a different set of conditions might well be postulated for copepods in waters with a smaller seasonal temperature variation. Hence the winter metabolism at 13° in one locality might be similar to that found elsewhere at lower temperatures; such regional differences are known for other poikilotherms (Spärck, 1936; Thorson, 1936; Fox and Wingfield, 1937; Scholander, *et al.*, 1953). A spring increase of *tonsa* occurred in Long Island Sound and at La Jolla; this could result only from a temporary superabundance of food during the spring flowering. The major difference in distribution in the two bodies of water occurred after the spring diatom maximum, when zooplankton were abundant and phytoplankton relatively scarce. In Allen's study the diatom numbers in La Jolla waters did not fall away so precipitously after the flowering as they did in the Sound. Nonetheless, the lowest quantity of *tonsa* in the California environment was found in both years during the late spring and early summer when the amount of phytoplankton was low.

Thus the distribution in both areas was probably controlled by the same environmental factors, but the more moderate conditions

at La Jolla seem to favor only limited competition during most of the year. When more severe competition did occur, it was approximately at the same season as in the Sound.

In northern European waters, *Acartia clausi* has a different seasonal cycle. Maxima are usually obtained in middle or late summer and minima occur in winter (Marshall, 1949; Digby, 1950; Wiborg, 1954). Wiborg has presented rather extensive hydrographic data for comparison with zooplankton distribution, and the data for three of his stations include reasonably complete seasonal cycles for *clausi*: Sognesjøen, at the mouth of Sognesfjord, 61° 04' N, 04° 50' W, depth 300 m; Ona, off Møre, 62° 54' N, 06° 30' E, depth 200 m; and Eggum, on the ocean side of the Lofoten Islands, 68° 23' N, 13° 39' E, depth 200 m.

At Sognesjøen, on the basis of incomplete data, maxima of *clausi* are indicated for June and September 1950; at Ona, in the same year, there was a major peak in August and a secondary one in November; at Eggum, the primary maximum occurred in September 1950, with a smaller peak in November. The two peaks recorded for each station suggest that two generations were produced. At Sognesjøen, surface temperatures warmed quickly from 10° at the beginning of June to 16° by the end of August, but in the fall, cooling was more gradual, with deepening of isotherms. At Ona, temperatures above 13° were recorded down to 50 m from August well into September and above 10° until mid-November. At Eggum maximum temperatures occurred in September, but temperatures remained fairly high until about the first of December. Thus, with the exception of Sognesjøen, where data were limited, the zooplankton and temperature maxima corresponded in 1950. Few if any *clausi* were produced until water temperatures reached 10° C, and breeding ceased in the fall when temperatures fell below this figure. In 1949, on the basis of such zooplankton data as were available, the seasonal picture for all stations was somewhat different. At each station the *clausi* maxima were about one month later, and only one successful generation was produced. The temperature distribution suggests that this was a much cooler summer, with maximum temperatures later and somewhat lower than those in 1950. Nonetheless, the abundance of *clausi* and the temperature distribution were closely correlated.

In Long Island Sound, respiratory and grazing observations indicate that *clausi* has an excellent chance of success in meeting food

requirements at temperatures between 8–16° C, but contrary to the situation in Norwegian waters, it also existed at much lower temperatures in local waters. Although *clausi* has a world-wide distribution and a wide range of temperature and salinity tolerances, in northern temperate waters, at least, it becomes a zooplankton dominant only under estuarine conditions.

It was mentioned earlier that the *Acartia* are not filter feeders in the strict sense (Lowndes, 1935); they do not make continuous vibratory movements of the head appendages, nor do they glide slowly while feeding in the manner of *Calanus finmarchicus*, creating a feeding current by their movements (Cannon, 1928). Instead, the *Acartia* obtain food by a series of grasping or raking movements, principally by the second maxillae. These movements are not nearly as rapid as those of *C. finmarchicus*, and they are made for only a short period, not more than a few seconds on the average.

Since the feeding mechanism of the *Acartia* appears to be less efficient than that of other copepods, they may not be successful in competition with "true" filtering forms; hence, the *Acartia* may attain an important position in the zooplankton community only when salinity restricts the distribution of other copepods.

Wiborg's data lend two important items of confirmatory evidence to this theory. First, the "true" filtering copepods, such as *Calanus*, had spring maxima in these northern waters, and second, the salinity minimum occurred in late summer and early fall at all of his stations. Thus salinity rather than temperature may be the most important limiting factor for the *Acartia* in competition with copepods of other genera. However, in the case of intrageneric competition such as has been described for Long Island Sound, temperature is probably the most significant physical factor.

Daily Zooplankton Production in the Sound

From the respiratory and grazing data accumulated in this study, the daily rate of zooplankton production can be estimated. The average displacement volume of total No. 10 net zooplankton from the Sound over a two year period was about 1 cc/m³, and the average water depth is about 20 m (see Riley's INTRODUCTION in this volume). Therefore, the total zooplankton mass per square meter of sea surface would be 20 g, assuming a specific gravity of about 1 for the plankton. At a mean temperature of 10.6° C, it can be estimated from Fig. 28A

(average of the two curves) that the grazing rate would be around 760 ml water/mg dry weight and day. The average weight loss on desiccation of mixed zooplankton samples was 90% which can be used to estimate that the water filtered per mg wet weight is about 85 ml/day. Hence, $20 \times 1000 \times 85$ or roughly 1700 liters of water were filtered by the zooplankton in 24 hours in a water column having an area of one square meter. The average chlorophyll content of Sound waters, exclusive of bloom periods, was about 5 μg chlorophyll/l and the chlorophyll varied seasonally in percent of organic matter from 0.60 to 1.40; an estimated mean of 0.75% seems reasonable. Assuming that approximately half of the organic content was carbon, the daily intake of the zooplankton would be $1700 \times (5 \times 10^{-6}) \times 0.50/0.0075 = 0.57$ g carbon. Since the organic matter of zooplankton was of the order of 10% of the wet weight and since half of this was carbon, it can be shown that the total zooplankton carbon in the water column was approximately 1 g. Thus the zooplankton would appear to consume over 50% of their carbon weight in 24 hours. From respiratory data for *Acartia* (converted to oxygen consumed per mg wet weight), a mean oxygen consumption of 0.028 ml O_2 /day can be calculated. Since there were 20 g of zooplankton in the water column, 0.56 ml represents total oxygen consumption per square meter, which may be converted to the daily carbon requirement in the manner previously described. Thus, 290 mg organic carbon are lost each day through respiration. The difference between carbon accrued in feeding and that lost in respiration is obviously the carbon production per day, or $570 - 290 = 280$ mg, assuming that 100% of the carbon ingested was assimilated. The rate of production, then, would be $(280/1000) \times 100$, or 28%.

Recent experiments by Marshall and Orr (1955) have shown that digestive efficiencies for *Calanus finmarchicus* are surprisingly high when fed several different phytoplankton species labeled with P_{32} . Experiments which we performed with *Acartia clausi* from British waters confirmed these high assimilation rates, using *Skeletonema costatum* and *Chaetoceros decipiens* as food organisms. Although only a few experiments were run with *clausi*, 80% assimilation would seem to be a reasonable estimate. Using this figure, our previous estimate of carbon intake becomes 456 mg, from which a revised daily production rate of 166 mg or 16.6% can be derived.

Respiration and grazing figures used for our estimate assumed

that *clausi* and *tonsa* were representative of the total zooplankton community and that grazing rates obtained with *Skeletonema costatum* were an index to the amount of water filtered by all species under all food conditions. Since the data presented in earlier sections of this paper indicate that feeding rates may vary with different food sources, the second assumption is probably unjustified. Moreover, since *clausi* and *tonsa* are dominant in the Sound, they might be better adapted than other members of the community. Although subject to these inadequacies, the Long Island Sound estimate compares favorably with Deevey's (1952b) figure of 16.7% for Block Island Sound (based on an assumption of 100% assimilation) and is slightly higher than Harvey's (1950) estimate of 10% for the English Channel.

REFERENCES CITED

- ALLEN, E. J. AND E. W. NELSON
1910. On the artificial culture of marine plankton organisms. J. Mar. biol. Ass. U. K., 8: 421-474.
- ALLEN, W. E.
1927a. Quantitative studies on inshore marine diatoms and dinoflagellates of southern California in 1921. Bull. Scripps Inst. Oceanogr. tech., 1: 19-29.
1927b. Quantitative studies on inshore marine diatoms and dinoflagellates of southern California in 1922. Bull. Scripps Inst. Oceanogr. tech., 1: 31-38.
- ANDREWARTHA, H. C. AND L. C. BIRCH
1953. The Lotka-Volterra theory of interspecific competition. Aust. J. Zool., 1: 174-177.
- BĚLEHRÁDEK, J.
1930. Temperature coefficients in biology. Biol. Rev., 5: 30-58.
- BIGELOW, H. B.
1926. Plankton of the offshore waters of the Gulf of Maine. Bull. U. S. Bur. Fish. (1924), 40 (2): 509 pp.
- BIGELOW, H. B. AND MARY SEARS
1939. Studies of the waters of the continental shelf, Cape Cod to Chesapeake Bay. III. A volumetric study of the zooplankton. Mem. Harv. Mus. comp. Zool., 54: 183-378.
- BOGOROV, B. G.
1934. Seasonal changes in biomass of *Calanus finmarchicus* in the Plymouth area in 1930. J. Mar. biol. Ass. U. K., 19: 585-612.
- CANNON, H. G.
1928. On the feeding mechanisms of the copepods, *Calanus finmarchicus* and *Diaptomus gracilis*. Brit. J. exp. Biol., 6: 131-144.
- CLARKE, G. L. AND D. P. BONNET
1939. The influence of temperature on the survival, growth, and respiration of *Calanus finmarchicus*. Biol. Bull. Woods Hole, 76: 371-383.

- CUSHING, P. H.
1951. The vertical migration of planktonic Crustacea. *Biol. Rev.*, *26*: 158-192.
- DAVIS, C. C.
1944. On four species of Copepoda new to Chesapeake Bay, with a description of a new variety of *Paracalanus crassirostris*. *Publ. Ches. Biol. Lab.*, No. *61*: 1-11.
- DEEVEY, G. B.
1948. The zooplankton of Tisbury Great Pond. *Bull. Bingham oceanogr. Coll.*, *12* (1): 1-44.
1952a. A survey of the zooplankton of Block Island Sound, 1943-1946. *Bull. Bingham oceanogr. Coll.*, *13* (3): 65-119.
1952b. Quantity and composition of the zooplankton of Block Island Sound, 1949. *Bull. Bingham oceanogr. Coll.*, *13* (3): 120-164.
- DIGBY, P. S. B.
1950. The biology of the small planktonic copepods of Plymouth. *J. Mar. Biol. Ass. U. K.*, *29*: 393-438.
- EDWARDS, G. A. AND L. IRVING
1943a. The influence of temperature and season upon the oxygen consumption of the sand crab, *Emerita talpoida* Say. *J. cell. comp. Physiol.*, *21*: 169-182.
1943b. The influence of season and temperature upon the oxygen consumption of the beach flea, *Talorchestia megalopthalma*. *J. cell. comp. Physiol.*, *21*: 183-189.
- ESTERLEY, C. O.
1928. The periodic occurrence of Copepoda in the marine plankton of two successive years at La Jolla, California. *Bull. Scripps Inst. Oceanogr. tech.*, *1*: 247-345.
- FOX, H. M. AND C. A. WINGFIELD
1937. The activity and metabolism of poikilothermal animals in different latitudes. II. *Proc. zool. Soc. Lond.*, *107A*: 275-282.
- FULLER, J. L.
1937. Feeding rate of *Calanus finmarchicus* in relation to environmental conditions. *Biol. Bull. Woods Hole*, *72*: 233-246.
- GAULD, D. T.
1951. The grazing rate of planktonic copepods. *J. Mar. Biol. Ass. U. K.*, *29*: 695-706.
1953. Diurnal variations in the grazing of planktonic copepods. *J. Mar. Biol. Ass. U. K.*, *31*: 461-474.
- GAULD, D. T. AND J. E. G. RAYMONT
1953. The respiration of some planktonic copepods. II. The effect of temperature. *J. Mar. Biol. Ass. U. K.*, *31*: 447-460.
- GAUSE, G. F.
1934. The struggle for existence. Williams and Wilkins Co., Baltimore. 163 pp.
- GAUSE, G. F. AND A. A. WITT
1935. Behavior of mixed populations and the problem of natural selection. *Amer. Nat.*, *69*: 596-609.
- GRANDORI, R.
1912. Studi sullo sviluppo larvale dei copepodi pelagici. *Redia*, *8*: 360-457.

- GURNEY, R.
1931. British fresh-water Copepoda. *Ray Soc. Publ. Vol. I.* 238 pp.
- HARVEY, H. W.
1937. Note on selective feeding by *Calanus*. *J. Mar. Biol. Ass. U. K.*, *22*: 97-100.
1950. On the production of living matter in the sea off Plymouth. *J. Mar. Biol. Ass. U. K.*, *29*: 97-137.
- HENDRY, N. I.
1954. Note on the Plymouth "Nitzschia" culture. *J. Mar. Biol. Ass. U. K.*, *33*: 335-339.
- HUTCHINSON, G. E.
1951. Copepodology for the ornithologist. *Ecology*, *32*: 572-577.
- KEYS, A. B.
1930. The measurement of the respiratory exchange of aquatic animals. *Biol. Bull. Woods Hole*, *59*: 187-198.
- KLUGH, A. B.
1929 and 1930. The effect of the U. V. component of sunlight on certain marine organisms. *Canad. J. Res.*, *1*: 100-109; *2*: 312-317.
- LEBOUR, M. V.
1922. The food of plankton organisms. *J. Mar. Biol. Ass. U. K.*, *12*: 644-677.
- LOWNDES, A. G.
1935. The swimming and feeding of certain calanoid copepods. *Proc. zool. Soc. Lond.*, 1935: 687-715.
- LUCAS, C. E.
1947. The ecological effects of external metabolites. *Biol. Rev.*, *22*: 270-295.
- LUMER, H.
1932. The reactions of certain Cladocera to colored lights of equal intensity. *Ohio J. Sci.*, *32*: 218-231.
- MARSHALL, S. M.
1949. On the biology of the small copepods of Loch Striven. *J. Mar. Biol. Ass. U. K.*, *28*: 45-122.
- MARSHALL, S. M., A. G. NICHOLLS, AND A. P. ORR
1934. On the biology of *Calanus finmarchicus*. V. Seasonal distribution, size, weight, and chemical composition in Loch Striven in 1933, and their relation to phytoplankton. *J. Mar. Biol. Ass. U. K.*, *19*: 793-828.
1935. On the biology of *Calanus finmarchicus*. VI. Oxygen consumption in relation to environmental conditions. *J. Mar. Biol. Ass. U. K.*, *20*: 1-27.
- MARSHALL, S. M. AND A. P. ORR
1955. On the biology of *Calanus finmarchicus*. VIII. Food uptake, assimilation and excretion in adult and stage V *Calanus*. *J. Mar. Biol. Ass. U. K.*, *34*: 495-529.
- NICHOLLS, A. G.
1933. On the biology of *Calanus finmarchicus*. I. Reproduction and seasonal distribution in the Clyde Sea-area during 1932. *J. Mar. Biol. Ass. U. K.*, *19*: 83-110.
1934. The developmental stages of *Euchaeta norvegica*, Boeck. *Proc. roy. Soc. Edinb.*, *56*: 31-50.

- OBERG, M.
1906. Die Metamorphose der Plankton-Copepoden der Kieler Bucht. *Wiss. Meeresuntersuch.*, 9: 39-103.
- PEARL, R. AND L. J. REED
1920. On the rate of growth of the population of the United States since 1790 and its mathematical representation. *Proc. nat. Acad. Sci., Wash.*, 6: 275.
- RAYMONT, J. E. G. AND F. GROSS
1941. On the feeding and breeding of *Calanus finmarchicus* under laboratory conditions. *Proc. roy. Soc. Edinb.*, 61: 267-287.
- RILEY, G. A.
1952. Theory of growth and competition in natural populations. *J. Fish. Res. Bd. Canada*, 10: 211-223.
- RILEY, G. A. AND S. GORGY
1948. Quantitative studies of summer plankton populations of the western North Atlantic. *J. Mar. Res.*, 7: 100-121.
- RILEY, G. A., H. STOMMEL, AND D. F. BUMPUS
1949. Quantitative ecology of the plankton of the western North Atlantic. *Bull. Bingham oceanogr. Coll.*, 12 (3): 1-169.
- RYTHER, J. H.
1954. Inhibitory effects of phytoplankton upon the feeding of *Daphnia magna* with reference to growth, reproduction, and survival. *Ecology*, 35: 522-533.
- SARS, G. O.
1903. An account of the Crustacea of Norway. *Bergen*. Vol. 4: 169 pp.
- SCHALLEK, W.
1942. The vertical migration of the copepod *Acartia tonsa* under controlled illumination. *Biol. Bull. Woods Hole*, 82: 112-126.
- SCHOLANDER, P. F., W. FLAGG, V. WALTERS, AND L. IRVING
1953. Climatic adaptation in arctic and tropical poikilotherms. *Physiol. Zool.*, 26: 67-92.
- SEWELL, R. B. S.
1948. The free-swimming planktonic Copepoda: Geographical distribution. *Sci. Rep. John Murray Exp. (1933-1934)*, 8: 318-592.
- SMITH, F. E. AND E. R. BAYLOR
1953. Color responses in the Cladocera and their ecological significance. *Amer. Nat.*, 87: 49-55.
- SPÄRCK, R.
1936. On the relation between metabolism and temperature in some marine lamellibranchs and its zoogeographical significance. *K. danske vidensk. Selsk. Skr., Biol.* 13 (5): 1-27.
- SPOONER, G. M.
1934. Observations on the reactions of marine plankton to light. *J. Mar. biol. Ass. U. K.*, 19: 385-438.
- SVERDRUP, H. U., M. W. JOHNSON, AND R. H. FLEMING
1942. The oceans; their physics, chemistry and general biology. Prentice-Hall, N. Y. 1087 pp.

- THOMPSON, T. G. AND R. J. ROBINSON
1939. Notes on the determination of dissolved oxygen in sea water. *J. Mar. Res.*, 2: 1-8.
- THORSON, G.
1936. The larval development, growth, and metabolism of arctic marine bottom invertebrates compared with those of other seas. *Medd. Grønland*, 100 (6): 1-155.
- WELLS, N. A.
1935a. The influence of temperature upon the respiratory metabolism of the Pacific killifish, *Fundulus parvipinnis*. *Physiol. Zool.*, 8: 196-227.
1935b. Variations in the respiratory metabolism of the Pacific killifish, *Fundulus parvipinnis*, due to size, season, and continued constant temperature. *Physiol. Zool.*, 8: 318-336.
- WHEELER, W. M.
1901. The free-swimming copepods of the Woods Hole region. *Bull. U. S. Fish. Comm.*, 19: 157-192.
- WIBORG, K. F.
1954. Investigations of zooplankton in coastal and offshore waters of western and northwestern Norway, with special reference to the copepods. *Rep. Norweg. Fish. Invest.*, 11 (1): 246 pp.
- WILSON, C. B.
1932. The copepods of the Woods Hole region, Massachusetts. *Bull. U. S. nat. Mus.*, 158: 635 pp.
- WIMPENNY, R. S.
1938. Diurnal variation in the feeding and breeding of zooplankton related to the numerical balance of the zoo-phyto-plankton community. *J. Cons. int. Explor. Mer*, 13: 323-337.
- ZEUTHEN, E.
1947. Body size and metabolic rate in the animal kingdom, with special regard to the marine micro-fauna. *C. R. Carlsberg, Chim.* 26: 17-161.

OCEANOGRAPHY OF LONG ISLAND SOUND, 1952-1954

VII. PELAGIC FISH EGGS AND LARVAE

By

SARAH B. WHEATLAND
Bingham Oceanographic Laboratory

TABLE OF CONTENTS

ABSTRACT.....	235
INTRODUCTION.....	235
ACKNOWLEDGMENTS.....	237
MATERIALS AND METHODS.....	238
SPECIES.....	246
<i>Clupea harengus</i>	246
<i>Brevoortia tyrannus</i>	248
<i>Anchoa mitchilli mitchilli</i>	253
<i>Anguilla rostrata</i>	257
<i>Enchelyopus cimbrius</i>	257
<i>Syngnathus peckianus</i>	262
<i>Menidia menidia notata</i>	263
<i>Cynoscion regalis</i>	263
<i>Menticirrhus saxatilis</i>	266
<i>Stenotomus chrysops</i>	267
<i>Tautoglabrus adspersus</i>	272
<i>Tautoga onitis</i>	272
<i>Ammodytes americanus</i>	277
<i>Scomber scombrus</i>	281
<i>Poronotus triacanthus</i>	282
<i>Prionotus carolinus</i>	284
<i>Prionotus evolans</i>	284
<i>Myoxocephalus</i> spp.....	286
<i>Paralichthys oblongus</i>	287
<i>Lophopsetta aquosa</i>	288
<i>Limanda ferruginea</i>	294
<i>Pseudopleuronectes americanus</i>	294
<i>Sphaeroides maculatus</i>	296
"Unknown 1".....	297

DISCUSSION.....	298
ADDENDUM ON EGG DIAMETER DECREASE.....	307
REFERENCES.....	310

ABSTRACT

The pelagic fish eggs and larvae of Long Island Sound, obtained in weekly oblique plankton tows from March 1952 until March 1954, are discussed in detail. An annotated list of 23 identifiable species, plus an unidentifiable one, contains pertinent information on spawning seasons, identification and measurements of eggs and larvae, their distribution, etc. Information derived from previous surveys is compared with that from 1952-1954. The physical and biological factors which may influence the abundance of eggs and larvae as well as a variety of explanations for the decrease in egg diameter of species with long spawning seasons are also presented.

INTRODUCTION

One of the many aspects of a broad oceanographic survey such as that discussed by Riley (see his INTRODUCTION in this volume) is a study of the spawning fish population. It is of more than passing interest to obtain information on the identity and seasonal fluctuations of the various components of the fish population and to evaluate and assess the environmental factors which may be responsible for changes in their annual abundance.

The present paper is limited primarily to an account of the identity, spawning locations, and seasonal fluctuations of those species taken from Long Island Sound in plankton tows from March 1952 until March 1954. In a few instances, observations and data attained after March 1954 have been included. Subsequent studies will concentrate on the causes of annual fluctuations, survival, growth, and abundance of the identified species. Surveys of the juvenile population are also planned.

Previous contributions on fish eggs and larvae which are particularly pertinent to the present study are those of Perlmutter (1939) and of Merriman and Sclar (1952). In the summer of 1938 Perlmutter surveyed the eggs and larvae in waters which immediately surround Long Island. His generalized account includes new data on identification as well as a few observations on temperature and salinity tolerance of some spawning species. In 1943-1946, Merriman and Sclar studied the eggs and larvae in northeastern Block Island Sound. Their paper includes an annotated list combined with a key for

identification of the eggs and larvae, as well as a discussion of possible meteorological and oceanographical features influencing the success of year-classes of cunner, weakfish, and butterfish.

The 1950 catch statistics, the most recent data available with county tabulations (U. S. Fish and Wildlife Service, 1951-1952), indicate that the waters adjacent to the three Connecticut counties on the north shore of L. I. S. produce less fish than the waters in the vicinity of New London County (Conn.) at the eastern end, where the catch is derived primarily from the B. I. S. population. Though L. I. S. is larger than B. I. S. and is confined almost entirely by two coastlines, it supports a much smaller commercial fishery than B. I. S., with the possible exception of menhaden. The shallow depth and less saline water of L. I. S. (Riley, 1952a) are factors that may deter the commercially valuable fish, such as cod and mackerel, from entering central and western L. I. S. in great numbers.

Of the migratory commercial species, the menhaden (*Brevoortia tyrannus*) enters L. I. S. during the warm months and is caught in abundance at that time. The greatest numbers in L. I. S. occur at the eastern end, and a large population may also be found just outside L. I. S. proper in the Peconic-Gardiners Bay area. The 1950 statistics indicate that 82,510,400 pounds of menhaden were landed at Suffolk County, New York (the center of the menhaden industry in this area), and some of this catch undoubtedly came from L. I. S. There is a variable and small recorded catch of herring, scup, and butterfish, but no appreciable catch of cod, haddock, mackerel, and fluke. No statistics are available on the number of weakfish and bluefish removed from these waters by sports fishermen. Two anadromous migrants, shad and alewife, are taken occasionally on the way to their spawning grounds, and these constitute the most lucrative river fishery in the southern New England area. However, they add relatively little to the total value of the Connecticut catch.

Of the permanent residents in the Sound, the blackback flounder (*Pseudopleuronectes americanus*) forms the backbone of the existing fishery. Even so, the recorded catch of blackbacks in 1950 was only 1/20th of that from B. I. S. *Lophopsetta aquosa*, *Myoxocephalus aeneus*, the minnow, and others, utilized as bait as well as food for humans and mink, add little to the total value of the fishery.

Except for the menhaden, it is clear that L. I. S. does not support an important commercial fishery. Nevertheless, from observations

by Greeley (1939), Perlmutter (1939), and Warfel and Merriman (1944), it appears that L. I. S. may well be a suitable area for young fish. Their reports show the presence of juveniles of commercially valuable forms as well as the young of inedible species which are an important part of the food chain. The juveniles of some species probably immigrate while others are hatched locally. No eggs or larvae of whiting (*Merluccius bilinearis*) and spotted hake (*Urophycis regius*) have been recorded from L. I. S. proper, but first-year specimens of both species have been collected in May and June by a local commercial oyster vacuum dredge. The juveniles hatched locally are subdivided into two groups; those spawned by seasonal immigrants such as menhaden, rockling, and kingfish (*Menticirrhus saxatilis*), and those spawned by residents, namely the blackback, sculpin, windowpane flounder, and others. A few, such as weakfish, may stem from both major sources. Thus, the Sound appears to be a nursery ground. How valuable a rôle these waters play in this respect is a matter of conjecture, but from the high concentration of plankton (see Riley and Conover in this issue) and the tremendous quantities of bottom organisms (see Sanders in this issue) it would appear that L. I. S. is a favorable location for young fish.

ACKNOWLEDGMENTS

It is a pleasure to acknowledge not only the guidance of Gordon A. Riley but also his helpful advice on problems pertaining to the hydrography of L. I. S. I am also indebted to Daniel Merriman for assistance in the identification of various fish eggs and for his constructive criticism of the manuscript.

Gordon Riley and Shirley M. Conover took the samples of zooplankton from which the eggs and larvae were obtained. Herbert W. Graham kindly provided working space at the U. S. Fish and Wildlife Service Laboratory in Woods Hole during the summer of 1954; and John Colton made available for examination the collections taken aboard the ALBATROSS III in the spring of 1953 and also made accessible the 1929 collections and unpublished data of O. E. Sette. Alfred Perlmutter provided unpublished material from the 1938 survey of Long Island waters and helped in identifying certain larvae. Special collections were made with the help of Captain Herman R. Glas, skipper of the SHANG WHEELER, the Gargano Brothers who fish aboard the Two BROTHERS, Jack Fu, Harvard 1957, and R.

Wade Covill, Yale 1957. To all I extend my gratitude and appreciation.

Special thanks are extended to Mr. Louis K. Mowbray, Yale 1955, who, with patience and thoroughness, sorted most of the material, identified and measured some of the samples, and prepared all of the menhaden data as well as some of the rockling material.

MATERIALS AND METHODS

Oblique zooplankton tows from L. I. S. from March 1952 until March 1954 were taken at a speed of two knots with a 12.5 cm No. 2 net attached to a Clarke-Bumpus sampler. Each entire 15-minute sample was immediately preserved in a 10% solution of neutralized formalin and sea water.

The tows were taken regularly at stations 1, 2, 5, and 8 (see Riley's INTRODUCTION to this volume for station positions). Two stations were sampled one week and two the next so that each of the four stations was sampled at biweekly intervals. During the first year, two cruises of wider geographical range were also made, one in June (hereafter referred to as the 100-cruise) and the other in September-October (the 200-cruise); each of these cruises was divided into two sections, the first part to the eastern end of the Sound and the second to the western end a week later. On these cruises, samples were taken at some 20 stations, from the Race at the eastern end to Execution Rock at the western end. A third long trip (the 300-cruise) in the spring of 1953 was cut short by poor weather. No samples were taken on the bottom during any of these cruises.

For various purposes, special tows were taken at different times throughout the two years. Studies were made of the eggs and larvae from hauls taken with the closing nets at two different depths as well as from night-day collections (see R. J. Conover in this issue). Seven hauls were taken in April and May 1954 to compare the catch in two nets towed simultaneously, one being a 12.5 and the other a 30 cm net.

A few samples of demersal juveniles were taken aboard the QUINNIPIAC, a suction oyster dredge operated by F. Mansfield and Sons Co. of New Haven, Conn. This apparatus sucks oysters and other organisms from the bottom through a rubber and steel pipe attached amidships (for details, see Anonymous, February, 1948), and it was possible to hang a net so as to sample the small demersal fish from

the overflow of water, but this method of sampling did not produce quantitative estimates.

After the eggs and larvae had been removed from the plankton sample they were identified, counted, and measured. The samples were not divided into aliquot portions. In all numerical analyses the exact number of eggs and larvae was standardized to the number taken per cubic meter of water sampled. Usually the diameter of all eggs was measured, but if numerous eggs of one species were found in a sample, 10 or 25 eggs were removed at random from the collection and measured. The total lengths of all larvae under 30 mm were measured by an ocular micrometer, but accurate measurements were sometimes difficult because the larvae curled.

Identifications were accomplished on the basis of known spawning seasons, diameter size of egg and oil globule, presence or absence of oil globule or globules, pigmentation of the embryo, and comparison with known material. The identification of larvae was made on the basis of apparent size at hatching, pigmentation, size at which the fins appear, number of metameres, fin ray counts where possible, and comparison with known material. The most useful references were: Kuntz, 1914, 1916; Kuntz and Radcliffe, 1917; Welsh and Breder, 1923; Nichols and Breder, 1926; Sette's unpublished drawings and descriptions from 1929; Hildebrand and Cable, 1930, 1934, 1938; Perlmutter, 1939; Merriman and Sclar, 1952; and Bigelow and Schroeder, 1953. For general information on spawning seasons, growth rates, and relative abundance, the following were helpful: Greeley, 1939; Sette, 1943; Warfel and Merriman, 1944; Moore, 1947; and Morrow, 1951. Hubbs' (1943) classification of the early stages was followed wherever possible.

The data are presented in sections according to species, following the classification of Berg (1940). Methods of identification are included where necessary; spawning seasons and locations are noted, and any variation in spawning between years is discussed; measurements of egg diameters are listed to demonstrate possible differences between spawning populations and to demonstrate the decrease in egg size with progress of the spawning season; measurements manifesting possible growth of the larvae during the year and brief reviews on the presence of juveniles are presented wherever possible; some environmental factors which may affect all of the above are discussed; and comparison with results of former surveys are made and evaluated.

TABLE I. RELATIVE ABUNDANCE OF FISH EGGS AND LARVAE PER CUBIC METER IN L. I. S, 1952-54

Species	1952									
	March		April		May		June		July	
	eggs	larv.	eggs	larv.	eggs	larv.	eggs	larv.	eggs	larv.
<i>Clupea harengus</i>	—	.007	—	—	—	—	—	—	—	—
<i>Brevoortia tyrannus</i>	—	—	—	—	—	—	—	—	—	—
<i>Anchoa mitchilli mitchilli</i>	—	—	—	—	—	—	2.28	.008	.01	—
<i>Anguilla rostrata</i>	—	—	—	—	—	—	10.62	—	33.36	1.05
<i>Enchelyopus cimbrius</i>	.44	—	.96	—	1.48	.027	.19	.01	—	—
<i>Syngnathus peckianus</i>	—	—	—	—	—	—	—	—	—	.01
<i>Menidia menidia notata</i>	—	—	—	—	—	—	—	.004	—	—
<i>Cynoscion regalis</i>	—	—	—	—	—	—	.36	—	.02	.08
<i>Menticirrhus saxatilis</i>	—	—	—	—	—	—	.004	—	.09	—
<i>Stenotomus chrysops</i>	—	—	—	—	.009	—	.67	—	.09	.02
<i>Tautoglabrus adspersus</i>	—	—	—	—	.96	—	2.38	—	1.37	—
<i>Tautoga onitis</i>	—	—	—	—	.24	—	.70	—	.01	—
<i>Ammodytes americanus</i>	—	1.98	—	.51	—	—	—	—	—	—
<i>Scomber scombrus</i>	—	—	—	—	—	—	.03	—	—	—
<i>Poronotus triacanthus</i>	—	—	—	—	—	—	.03	—	.19	—
<i>Prionotus carolinus</i>	—	—	—	—	—	—	.03	—	.03	.02
<i>Prionotus esolans</i>	—	—	—	—	—	—	.09	—	.01	—
<i>Myoxocephalus</i> spp.	—	.01	—	—	—	—	—	—	—	—
<i>Paralichthys oblongus</i>	—	—	—	—	—	—	—	—	—	—
<i>Lophopsetta aquosa</i>	—	—	.03	—	.93	—	1.2	.03	.04	.01
<i>Limanda ferruginea</i>	—	—	—	.009	—	—	—	—	—	—
<i>Pseudopleuronectes americanus</i>	—	—	—	.04	—	.10	—	.01	—	—
<i>Sphaeroides maculatus</i>	—	—	—	—	—	—	—	—	—	—
"Unknown 1"	—	—	—	—	—	—	—	—	—	—

TABLE I. (continued)

Species	1952									
	August		September		October		November		December	
	eggs	larv.	eggs	larv.	eggs	larv.	eggs	larv.	eggs	larv.
<i>Clupea harengus</i>	—	—	—	—	—	—	—	—	—	—
<i>Brevoortia tyrannus</i>	.03	—	.27	.16	.10	.26	—	—	—	—
<i>Anchoa mitchilli mitchilli</i>	21.84	3.58	.41	1.26	—	.02	—	—	—	—
<i>Anguilla rostrata</i>	—	—	—	—	—	—	—	—	—	—
<i>Enchelyopus cimbrius</i>	—	—	—	—	—	—	—	—	—	—
<i>Syngnathus peckianus</i>	—	—	—	—	—	—	—	—	—	—
<i>Menidia menidia notata</i>	—	—	—	—	—	—	—	—	—	—
<i>Cynoscion regalis</i>	.03	—	—	—	—	—	—	—	—	—
<i>Menticirrhus saxatilis</i>	—	.01	—	—	—	—	—	—	—	—
<i>Stenotomus chrysops</i>	—	—	—	—	—	—	—	—	—	—
<i>Tautoglabrus adspersus</i>	.16	.05	.09	.04	.05	.02	—	—	—	—
<i>Tautoga onitis</i>	—	—	—	—	—	—	—	—	—	—
<i>Ammodytes americanus</i>	—	—	—	—	—	—	—	—	—	.05
<i>Scomber scombrus</i>	—	—	—	—	—	—	—	—	—	—
<i>Poronotus triacanthus</i>	.01	—	—	—	—	—	—	—	—	—
<i>Prionotus carolinus</i>	.03	.01*	—	—	—	—	—	—	—	—
<i>Prionotus esolans</i>	—	—	—	—	—	—	—	—	—	—
<i>Myoxocephalus</i> spp.	—	—	—	—	—	—	—	—	—	—
<i>Paralichthys oblongus</i>	—	—	—	.009	—	—	—	—	—	—
<i>Lophopsetta aquosa</i>	—	—	.36	.006	.37	.005	—	—	—	—
<i>Limanda ferruginea</i>	—	—	—	—	—	—	—	—	—	—
<i>Pseudopleuronectes americanus</i>	—	—	—	—	—	—	—	—	—	—
<i>Sphaeroides maculatus</i>	—	.01	—	—	—	—	—	—	—	—
"Unknown 1"	—	—	.009	—	.01	—	—	—	—	—

* In the text these larvae are referred to as *Prionotus* sp.

TABLE I. (continued)

Species	1953		December		January		1954		March	
	November		eggs	larv.	eggs	larv.	eggs	larv.	eggs	larv.
<i>Clupea harengus</i>	—	—	—	—	—	—	—	—	—	—
<i>Brevoortia tyrannus</i>	—	.47	—	.02	—	—	—	—	—	—
<i>Anchoa mitchilli mitchilli</i>	—	.02	—	—	—	—	—	—	—	—
<i>Anguilla rostrata</i>	—	—	—	—	—	—	—	—	—	—
<i>Enchelyopus cimbrius</i>	—	—	—	—	—	—	.04	—	.11	—
<i>Syngnathus peckianus</i>	—	—	—	—	—	—	—	—	—	—
<i>Menidia menidia notata</i>	—	—	—	—	—	—	—	—	—	—
<i>Cynoscion regalis</i>	—	—	—	—	—	—	—	—	—	—
<i>Menticirrhus saxatilis</i>	—	—	—	—	—	—	—	—	—	—
<i>Stenotomus chrysops</i>	—	—	—	—	—	—	—	—	—	—
<i>Tautoglabrus adspersus</i>	—	—	—	—	—	—	—	—	—	—
<i>Tautoga onitis</i>	—	—	—	—	—	—	—	—	—	—
<i>Ammodytes americanus</i>	—	—	—	.46	—	.50	—	.43	—	—
<i>Scomber scombrus</i>	—	—	—	—	—	—	—	—	—	—
<i>Poronotus triacanthus</i>	—	—	—	—	—	—	—	—	—	—
<i>Prionotus carolinus</i>	—	—	—	—	—	—	—	—	—	—
<i>Prionotus evolans</i>	—	—	—	—	—	—	—	—	—	—
<i>Myoxocephalus</i> spp.	—	—	—	—	—	—	—	—	—	.03
<i>Paralichthys oblongus</i>	—	—	—	—	—	—	—	—	—	—
<i>Lophopsetta aquosa</i>	.02	—	—	—	—	—	—	—	—	—
<i>Limanda ferruginea</i>	—	—	—	—	—	—	—	—	—	—
<i>Pseudopleuronectes americanus</i>	—	—	—	—	—	—	—	—	—	.01
<i>Sphaeroides maculatus</i>	—	—	—	—	—	—	—	—	—	—
"Unknown 1"	—	—	—	—	—	—	—	—	—	—

TABLE II. PERTINENT DATA FROM THE 1952-54 SURVEY OF L. I. S.

Species	Date	Eggs			Oil globules		
		Number	Size range (mm)	Ar. & Stand. deviation	Size range (mm)	Ar. & Stand. deviation	Number egg
<i>Clupea harengus</i>	—	—	—	—	—	—	—
<i>Brevoortia tyrannus</i>	{ June-July } { Aug.-Oct. }	633	1.04-1.94	1.61±.05	.06-.20	.14±.02	1-2
<i>Anchoa mitchilli mitchilli</i>	June-Sept.	8333	0.70-1.05	0.84±.05	—	—	0
<i>Anguilla rostrata</i>	—	—	—	—	—	—	—
<i>Enchelyopus cimbrius</i>	Feb.-June	595	0.74-1.12	0.89±.04	.05-.30	—	1-25
<i>Syngnathus peckianus</i>	—	—	—	—	—	—	—
<i>Menidia menidia notata</i>	—	—	—	—	—	—	—
<i>Cynoscion regalis</i>	June-Aug.	123	0.75-0.96	0.84±.03	.05-.30	.20±.04	1-6
<i>Menticirrhus saxatilis</i>	June-Aug.	27	0.75-0.91	0.81±.03	<.05-.14	—	6-22
<i>Stenotomus chrysops</i>	May-July	209	0.85-1.15	0.96±.04	.14-.28	.22±.02	1-2
<i>Tautoglabrus adspersus</i>	May-Oct.	2105	0.76-1.03	0.86±.04	—	—	0
<i>Tautoga onitis</i>	May-Aug.	340	0.91-1.15	1.05±.03	—	—	0
<i>Ammodytes americanus</i>	—	—	—	—	—	—	—
<i>Scomber scombrus</i>	May-June	9	1.14-1.29	1.18±.02	.24-.35	.29±.01	1
<i>Poronotus triacanthus</i>	June-Aug.	26	0.69-0.80	0.75±.02	.14-.22	.18±.01	1-2
<i>Prionotus carolinus</i>	June-Aug.	22	1.00-1.25	1.10±.02	<.10-.17	—	7-20
<i>Prionotus evolans</i>	June-July	25	1.05-1.25	1.14±.03	>.10-.16	—	7-30
<i>Myoxocephalus</i> spp.	—	—	—	—	—	—	—
<i>Paralichthys oblongus</i>	—	—	—	—	—	—	—
<i>Lophopsetta aquosa</i>	{ April-Aug. } { Sept.-Nov. }	571	0.90-1.38	1.07±.06	.05-.30	.16±.03	1-4
<i>Limanda ferruginea</i>	April	1	0.81	—	—	—	0
<i>Pseudopleuronectes americanus</i>	—	—	—	—	—	—	—
<i>Sphaeroides maculatus</i>	—	—	—	—	—	—	—
"Unknown 1"	Sept.-Oct.	4	0.72-0.89	.78	.14-.24	.17	1-3

TABLE II. (continued)

Species	Date	Larvae	
		Number	Range (mm)
<i>Clupea harengus</i>	Mar.	1	34.90
<i>Brevoortia tyrannus</i>	{ June Aug.-Dec. }	150	2.35-20.6
<i>Anchoa mitchilli mitchilli</i>	July-Nov.	672	1.60-28.0
<i>Anguilla rostrata</i>	Jan.	1	56.90
<i>Enchelyopus cimbrius</i>	April-June	8	2.00-4.90
<i>Syngnathus peckianus</i>	July	1	10.90
<i>Menidia menidia notata</i>	June	1	5.30
<i>Cynoscion regalis</i>	July-Aug.	14	2.10-4.40
<i>Menticirrhus saxatilis</i>	Aug.	1	3.70
<i>Stenotomus chrysops</i>	July	4	2.50-3.20
<i>Tautoglabrus adspersus</i>	July-Oct.	16	2.40-4.60
<i>Tautoga onitis</i>	July	1	2.50
<i>Ammodytes americanus</i>	Dec.-May	506	3.10-33.5
<i>Scomber scombrus</i>	—	—	—
<i>Poronotus triacanthus</i>	—	—	—
<i>Prionotus carolinus</i>	{ July-Aug. }	2	2.20-3.00
<i>Prionotus evolans</i>			
<i>Myoxocephalus</i> spp.	Mar.-Apr.	10	3.70-9.10
<i>Paralichthys oblongus</i>	Sept.	1	3.00
<i>Lophopsetta aquosa</i>	{ June-July Sept.-Oct. }	17	1.80-7.60
<i>Limanda ferruginea</i>	April	1	13.80
<i>Pseudopleuronectes americanus</i>	Mar.-June	63	2.80-8.50
<i>Sphaeroides maculatus</i>	Aug.	1	5.00
"Unknown 1"	—	—	—

SPECIES

Clupea harengus Linnaeus; Herring

No demersal eggs were obtained, and only one larva (34.90 mm) was taken, at St. 2 on March 26, 1952. The fin counts showed 18 dorsal and 17 anal rays. According to Breder (1929), the herring spawns in November in the latitude of New York, so this larva was presumably the product of early to mid-winter spawning.

The water temperature in L. I. S. during the herring spawning season agreed with that given by Bigelow and Schroeder (1953) for Cape Cod and with the range given by MacFarland (1913) for successful hatching. However, the bottom salinity in the Sound in November, c 28‰, was lower than the minimum given by Bigelow and Schroeder (31.9‰) for successful reproduction.

Merriman and Sclar (1952) have pointed out the inherent difficulties in separating larvae of *C. harengus* and *Brevoortia tyrannus*. They identified the clupeoid larvae taken in fall and winter from B. I. S.

as *C. harengus*, but re-examination of these same larvae by Merriman and the author has revealed that most of them were actually *B. tyrannus*. The length at which the anal fin is formed, 30 mm in the herring and 13-20 mm in the menhaden, was the dominant consideration. On this basis, the small larvae taken in their fall tows from B. I. S. were *B. tyrannus*. Some other specimens (between 23 and 27 mm) taken a little later the same fall were so mangled that re-identification was impossible. The largest (30 mm), taken in January 1946, was originally identified correctly as *C. harengus*.

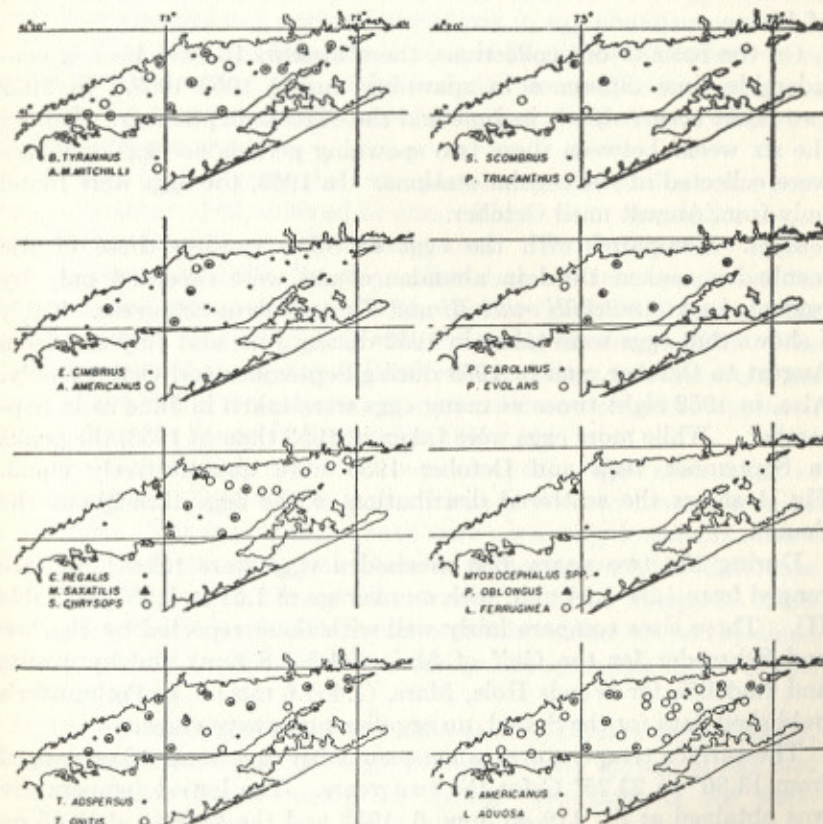

Figure 1. Locations of egg and larvae collections in L. I. S., 1952-54.

Brevoortia tyrannus (Latrobe); Menhaden

This species usually enters the Sound in late spring and stays until October, during which time it is caught in large quantities for processing into oil, fertilizer, and poultry feed on Long Island.

Spawning. Kuntz and Radcliffe (1917) reported that menhaden spawn in summer at Woods Hole, Mass. and in late fall and early winter in Chesapeake Bay. They suggested the possibility of two spawning seasons in Chesapeake Bay, but Hildebrand and Schroeder (1928) maintained that there was only one. Perlmutter (1939) reported spawning from May until October in the Long Island area, the height of the season being in May. According to Bigelow and Schroeder (1953) the menhaden is a summer spawner in the Gulf of Maine.

On the basis of our collections, there appears to have been a considerable time difference in spawning during 1952-1953. In 1952 two peaks occurred, one in June and the other in September. During the six weeks between these two spawning periods no eggs or larvae were collected at the regular stations. In 1953, the eggs were found only from August until October.

Eggs. Compared with the eggs of other species, those of the menhaden ranked third in abundance and were exceeded only by eggs of *Anchoa mitchilli mitchilli* and *Tautoglabrus adspersus*. Table I shows that eggs were taken in 1952 during June and July and from August to October, and in 1953 during September and October only. Also, in 1952 eight times as many eggs were taken in June as in September. While more eggs were taken in 1952 than in 1953, the peaks in September 1952 and October 1953 were quantitatively equal. Fig. 1 shows the scattered distribution of the eggs throughout the Sound.

During the two years, 633 menhaden eggs were taken; the size ranged from 1.04-1.94 mm, with an average of 1.61 ± 0.05 (see Table II). These sizes compare fairly well with those reported by Bigelow and Schroeder for the Gulf of Maine (1.5-1.8 mm) and by Kuntz and Radcliffe for Woods Hole, Mass. (1.4-1.6 mm). In Perlmutter's published data for the Sound, no egg diameters were given.

The surface temperatures when menhaden eggs were taken ranged from 13.30° to 23.25° C for the two years. The lowest temperature was obtained at St. 119 on June 6, 1952 and the highest at St. 5 on August 19, 1952. In 1953 the over-all temperature range was less

than that in 1952: from 22.50° at St. 5 on August 25 down to 18.70° by October 14 at St. 5. Presumably these fish spawn when the temperature is above 16°. The water in Peconic-Gardiners Bay warms up earlier, and Perlmutter found menhaden spawning there in May.

The surface salinities at the time the menhaden eggs were collected ranged from 18.15 to 28.41‰ during 1952-1953; the lowest salinity was at St. 113 on June 5, 1952, the highest at St. 5 on October 14, 1953. The temperature and salinity data did not reveal differences that were significant enough to account for the paucity of menhaden eggs during the spring of 1953.

Examination of the data reveals seasonal differences in egg diameter as well as seasonal and regional variations in egg abundance. Table III compares the data from the June and September-October cruises in 1952 with data for 1953. Also included for comparative purposes are data for three geographical subdivisions of the Sound—eastern, central, and western.

The eggs taken during the two spawning peaks, in June and September-October 1952, differed in size. Those from the earlier cruise were larger than those of the later one. The average size of the eggs decreased in 1952, but no similar decrease was noted in 1953. However, the average size of the eggs in the fall of 1952 and of 1953 was the same. The oil globule was noticeably smaller in 1953. The major portion of the spring collections was taken in June from the eastern part of the central area; no particular concentration appeared anywhere in the Sound in September 1952.

At the eastern end, near the Race, menhaden eggs were taken at seven stations. Each of the stations was located within a few miles of the next. The eggs taken in June were noticeably larger than those obtained in September, but there was no appreciable difference in the numbers taken during either cruise, with the exception of St. 115. Possibly the increase in numbers at this station can be explained by its proximity to Peconic Bay, a recognized spawning locale of this species in spring.

In the east-central section, as in the eastern portion of the Sound, the average diameter of the eggs decreased from spring to fall and more eggs were found during the spring. However, in the west-central area a decrease was noted only at St. 5, where the largest number of eggs was collected.

TABLE III. SEASONAL AND REGIONAL VARIATIONS IN ABUNDANCE AND SIZE OF EGGS OF *Brevoortia tyrannus*

Eastern End				Central Portion				Western End						
St.	Eggs/m ³		Av. diam.	Date	St.	Eggs/m ³		Av. diam.	'52	'53	St.	Eggs/m ³		Av. diam.
	St.	Eggs/m ³				Eggs/m ³	Eggs/m ³					St.	Eggs/m ³	
119	0.48	1.64	1.74		105	0.17	1.55				180	0.49	1.71	
222	0.58	1.58	1.54		205	0.22	1.53				241	0.10	1.45	
117	0.68	1.68	1.69		103	0.18	1.74				284	0.10	1.60	
219	0.49	1.56	1.55		203	0.00	—							
				VI	107	4.96	1.67							
115	2.02	1.71	1.71	IX-X	1	0.08	1.65		0.04	0.00				
218	0.22	1.53	1.71		1	0.00	—							
				VI	2	0.22	1.55							
220	0.47	1.52	1.47	IX-X	2	0.03	1.53							
				VI	5	1.09	1.63							
				IX-X	5	0.70	1.44							
				VI	8	0.00	—							
				IX-X	8	0.00	—							

SUMMARY:

Date	Cruise	No. eggs measured	Range (mm)	Av. diam.	Stand. dev.	Av. diam. globule
1952 VI	100	108	1.46-1.82	1.68	0.073	0.15
IX-X	200	43	1.36-1.65	1.51	0.034	0.14
1953 IX-X	—	23	1.05-1.61	1.48	0.049	0.11

Although only a few eggs were taken in the western section in either spring or fall, a decrease in egg size was evident. (Perlmutter found a number of eggs in this region in June, but none in the fall.) The October 1952 collections may have been made after the end of the spawning season. No doubt the menhaden spawned here, because many small larvae were taken at this time.

From the available data it appears that two groups of menhaden migrated into L. I. S. in the summer of 1952. The first group arrived in early June, moved westward, and produced larger eggs than the menhaden of the later group, which had moved into the center of the Sound by August 19th. In 1953 only a later group arrived and produced eggs of the same size as those of the later group in 1952.

Merriman and Sclar (1952) did not find eggs of this species in B. I. S., nor did Perlmutter find them in his samples from B. I. S. despite the reported abundance of eggs in Peconic-Gardiners Bay. According to Bigelow and Schroeder, "the abundance of microscopic plants in waters of bays and estuaries . . . has often been invoked to explain the concentration of menhaden close to shore." This reasoning may account for the presence of this species in L. I. S. and not B. I. S. Comparison of data in Riley (1952b) and in S. M. Conover in this issue shows a greater abundance of phytoplankton in L. I. S. than in B. I. S. Also, the plankton populations in L. I. S. during June and July 1952 were greater than those of 1953. However, the menhaden, in entering Peconic Bay and eastern L. I. S., may come around Montauk Point without entering northern B. I. S. at all.

Larvae. A total of 150 larvae (2.35-20.6 mm) was taken in L. I. S. in 1952-1953. Two specimens were taken in June 1952, 71 in September-October 1952, and 77 in September-December 1953. The menhaden larvae were exceeded in abundance by only those of *Anchoa mitchilli mitchilli* and *Ammodytes americanus*. The numerical ratio of larvae to eggs varied as follows during the two years: 1:2 in 1952, 3.2:1 in 1953. The 1952 ratio was high when compared with that of other species, and the 1953 ratio indicates that we did not collect the eggs at the time or location of greatest spawning. In 1952 a large sampling error, failure of the larvae to survive, or a combination of these and other factors may account for the fact that the greatest number of eggs was taken in spring and the greatest number of larvae in the fall.

According to Bigelow and Schroeder (1953), menhaden are unable

to survive in water temperatures below 10° C. Warfel and Merriman (1944) did not find juveniles in Morris Cove after the temperature fell below 8°. In L. I. S. the larvae were not taken in 1952 after the surface temperature decreased to 13.55° (October 29 at St. 8), but in 1953 the larvae were taken until the surface temperature decreased below 10.30° (December 2, St. 1). The early disappearance of the larvae during the fall of 1952 may have been due to the fact that the waters of the Sound cooled faster that year, since 10.30° was recorded as early as November 17.

The salinities where the larvae were collected ranged from 25.11 (St. 1, June 19, 1952) to 28.44‰ (St. 1, December 2, 1953). Massman (1954) found juveniles in fresh water 35 miles above brackish water in rivers of Virginia. Possibly the juveniles had a greater tolerance for lower salinities than the adults.

Comparison of our data with those of others reveals some pertinent information about early growth. Kuntz and Radcliffe (1917) reported that the newly hatched larva at Woods Hole, Mass. is 4.5 mm long, but some larvae in our collections from the Sound were as short as 2.4 mm. Considering that newly hatched larvae appeared constantly during the early fall, it is impossible to obtain an estimate of seasonal growth rate based on length frequencies. However, three larvae (12.5, 13.4, 20.6 mm long) were taken on December 2, 1953 seven weeks after the last eggs had been found. If we assume that these larvae hatched around October 14 and had grown to these sizes in seven weeks, then their growth rate must have been slower than 50 mm in three months, as estimated by Perlmutter and by Warfel and Merriman. The decreasing temperatures of the water column may have accounted for this decreased growth rate in the Sound. In this connection Hildebrand and Schroeder (1928) reported that the growth rate over the winter in Chesapeake Bay was very slow. At the present time an estimated growth rate of 50 mm in three months during the summer and of 12–20 mm in two months during the fall is the best available.

Warfel and Merriman (1944) maintained that the wide fluctuations in mean length as well as the constant presence of 30 mm fish in each sample indicated that successive waves of different populations were moving into Morris Cove. This phenomenon might be attributed to spawning by different populations at various times. The smaller fish in their October samples might have been products of late summer

spawning, the larger ones the products of early summer spawning. Migrations of juveniles from areas of later spawning have also been postulated by Nichols and Breder (1926).

Anchoa mitchilli mitchilli (Cuv. & Val.); Anchovy.

Though not important commercially, the anchovy is a common prey, hence its importance to the economy of L. I. S. may be great even though indirect.

Spawning. Perlmutter (1939) ascertained that anchovy eggs were the most abundant of all species in Peconic-Gardiners Bay and in L. I. S., and Nichols and Breder (1926) and Sumner, *et al.* (1913) have listed it as abundant in the summer at Woods Hole, where it undoubtedly spawns. However, neither Perlmutter nor Merriman and Sclar found it in B. I. S., possibly because the area they sampled is not sufficiently protected from the open sea to support a large population.

Eggs. The eggs of this species were more abundant in our catches than those of any other fish. Table II shows a total of 8,333 eggs (0.70–1.05 mm) for 1952–1953. In 1952 they were found from June 4 to September 3, and in 1953 from June 23 to August 25. The quantity of eggs taken in 1952 was five times greater than that in 1953 (see Fig. 1 for locations of collections).

In 1952 the lowest surface temperature in which these eggs were collected was 13.30° C at St. 119 on June 6 and the lowest salinity was 19.93‰ at St. 128 on June 11; the warmest surface temperature was 23.30° on August 12 and the highest salinity was 27.89‰ on August 26, both at St. 8. In 1953 the temperature range, from 18.45° on June 23 at St. 1 to 23.50° by July 21 at St. 1, was less than that in 1952; the salinity in 1953 varied between 25.15 and 27.23‰. On the basis of these data and Perlmutter's, the eggs may be expected to occur anytime after the temperature of the water column reaches 13°. However, in 1953 they were not taken at the regular stations until the surface temperature was 18.45°. Another factor that may have been partially responsible for their delayed appearance was the lower salinity in the spring of 1953.

In June 1952 the 100-cruise was made during the beginning of the spawning season, when eggs were collected from 14 of the 19 stations scattered throughout the Sound. In actual numbers, more eggs were taken at the western than at the eastern end, perhaps because

the cruise to the western part came as the spawning season was well underway whereas the cruise to the eastern section came at the beginning of the spawning season. In 1938 Perlmutter found the greatest number of eggs in Peconic Bay and to the south of Long Island whereas in L. I. S. proper he found comparatively few.

Table IV indicates that, on the whole, anchovy eggs were more abundant inshore at Sts. 1 and 8 than offshore at Sts. 2 and 5. However, there were occasional abundant collections of eggs at Sts. 2 and 5 also. This suggests the possibility of a correlation between northerly (offshore) winds and the abundance of eggs at the offshore stations. In Table IV the number of eggs is given for each collection from these four stations during the summers of 1952 and 1953; also given is an average of the wind direction for the collection date plus the two preceding days (determined from monthly summaries of the U. S. Weather Bureau Office at New Haven, 1952-1953). In 1952, when there was a prevalence of southwesterlies on or before the collection dates and when more eggs were taken, the majority was found inshore; on the other hand in 1953, when the winds were more variable and the eggs less abundant, the majority was found offshore at St. 2. However, when each collection is considered individually, the greater egg abundance at the offshore stations does not appear to be related to wind direction. If one considers the data for St. 5 only, it is seen that the greatest fluctuation in abundance during 1952 occurred primarily between June 24 and July 8. It is possible that eggs were carried through this station on the ebbing tide which sweeps by this location fairly rapidly (Riley, 1952a), but since more eggs were sometimes taken following an easterly wind, the eggs at such times may have been prevented from moving out of this area with the tide. In 1953 there was less variation in the numbers of eggs except at St. 2 on July 28, when a tremendous increase occurred. No north wind was responsible. Although St. 1 appears to have been the locale of the heaviest spawning in 1952, it was not so in 1953. Evidence suggests that the large fluctuations that have been discussed were caused by movements of the fish. There may have been some scattered groups of anchovies whose eggs were found chiefly at Sts. 1, 2, and 8 and other groups whose eggs were swept through St. 5 from a more westerly or inshore locale.

Discussion of the noticeable changes in shape and size of anchovy eggs is advisable to aid future studies. The egg is elliptical and

TABLE IV. ABUNDANCE OF *A. m. mitchilli* PER CUBIC METER AND THE WIND DIRECTION FOR THE DATE OF COLLECTION PLUS THE TWO PRECEDING DAYS

Date	Stations				Wind direction
	Inshore	8	2	Offshore	
1952					
VI-4	1.2	—	0.09	—	NW, SE, S
VI-19	123.0	24.2	—	—	SW, NW, SW
VI-24	31.8	—	—	24.5	NE, E, SW
VII-1	—	—	26.9	—	S, N, N
VII-8	16.7	—	—	4.8	SW, SW, E
VII-15	65.5	93.4	46.1	—	NW, SW, SW
VII-22	19.8	—	—	7.4	SW, SW, SW
VII-29	—	5.8	12.8	—	SW, SW, NW
VIII-5	6.7	—	—	9.3	SW, SE, S
VIII-12	—	36.3	37.8	—	E, SW, SW
VIII-19	79.8	—	—	4.9	NW, W, W
VIII-26	—	2.4	4.6	—	NW, SW, SW
1953					
VI-23	0.15	0.16	—	—	E, SW, W
VI-30	—	—	0.11	0.0	S, SW, S
VII-7	0.0	1.7	—	—	S, SE, SW
VII-14	—	—	0.6	0.26	E, N, E
VII-21	4.2	0.76	—	—	E, N, N
VII-28	—	—	29.3	0.9	S, S, N
VIII-4	3.0	8.4	—	—	N, N, S
VIII-11	—	—	0.43	2.3	E, S, W
VIII-18	5.5	3.3	—	—	S, W, N
VIII-25	—	—	0.65	0.0	S, SW, SE

Summary of annual relative abundance of eggs and larvae at each station.

EGGS				
1952	31.10	24.49	17.28	8.86
1953	2.29	3.06	6.83	0.66
LARVAE				
1952	2.05	2.42	5.94	0.46
1953	0.15	0.48	0.69	0.15

contains no oil globule. Most of the investigators who have referred to this species in more northern latitudes quote Kuntz (1914), who found that eggs taken in plankton tows near Beaufort, North Carolina were 0.65-0.75 mm in length and about 0.55-0.61 mm in width. In the L. I. S. survey, usually only the long axis was measured, but the length of the short axis was ascertained for eggs from a few hauls in June, July, and August 1952. The shape varied widely from nearly round to long and narrow, but this difference appeared to be random. The size also varied considerably during the spawning season. Table V summarizes the egg measurements for each month during the spawning seasons of both years.

TABLE V. SUMMARY OF MEASUREMENTS OF *A. m. mitchilli* EGGS

Date	No. meas.	Range	Ave. of long axis	Ratio long/short axis	Stand. dev.
1952					
June	671	0.75-1.00	0.89	1.17	.046
July	716	0.70-1.00	0.82	1.15	.047
August	481	0.70-0.95	0.79	1.19	.040
Sept.	25	0.75-0.91	0.80	—	.037
1953					
June	5	0.80-0.93	0.86	—	.024
July	105	0.76-0.95	0.86	—	.040
August	154	0.71-0.91	0.82	—	.039
Total					
1952	1893	0.70-1.05	0.84	—	.045
1953	264	0.71-0.95	0.84	—	.039

From the available evidence it appears that the L. I. S. anchovies produce larger eggs than those from the south. Although the average size within L. I. S. was the same in both years, there was considerable variation within each year. In 1952, although the size range remained relatively constant, the average decreased in July through August and then increased again in September; in 1953 the average decrease was less obvious. The decrease in size is an important variable which is helpful in proper identification. While the shape of the engraulid egg identifies it from those of other families, size variations are important when separating the eggs of two or more species of anchovies. Since the phenomenon of decreasing diameter has occurred in other species, possible explanations are presented in the DISCUSSION, p. 307.

Larvae. Of all larvae taken during the summer, these were the most abundant with a total of 672, of which 520 were obtained in 1952 from July through October and 152 in 1953 from July through November. Their length ranged from 1.60-28.0 mm. The numerical ratio of larvae to eggs varied from 1:14.4 in 1952 to 1:5.5 in 1953; as in the case of menhaden larvae, sampling errors, failure to survive, and other factors probably account for this difference in the two years.

Inasmuch as most of the larvae were taken from stations of greatest egg abundance, the temperature range for the larvae was similar to that recorded for the eggs, excepting St. 5 on November 23, 1953, where the temperature had decreased to 12.90° C when the larvae were taken.

The anchovy tolerates a wide range of salinity, as shown by Massman (1954) who collected adults and juveniles as much as 40 miles upstream from brackish water in Virginia rivers. His recorded salinities varied between 0 and 12.6‰. As yet it is not known how far anchovies travel up Connecticut rivers.

During prolarval and early postlarval stages, *A. m. mitchilli* and *B. tyrannus* resemble each other for the most part, but there are two primary characteristics by which they may be separated: (1) proportionate distance from vent to tip of tail in total length, and (2) the time of finray differentiation. In *A. m. mitchilli* the distance from vent to tip of tail is between 25-34% of the total length whereas in *B. tyrannus* it is usually between 16-25%. In the former the dorsal fin rays begin to differentiate at 5-6 mm while in *B. tyrannus* they do not appear until 9 mm (Kuntz, 1914; Kuntz and Radcliffe, 1917).

An estimate of the early growth rate from the 1952-1953 data is impossible because the continual addition of newly hatched larvae masks recognition of resampled homologous groups and prevents accurate analysis. Perlmutter has estimated early growth as about 10 mm per month.

*Anguilla rostrata*¹ (Le Seuer); American eel.

According to Bigelow and Schroeder, young eels appear in March at Woods Hole, Mass. and in middle or late April in Narragansett Bay, Rhode Island. Nichols and Breder (1926) have reported that elvers were common in April in bays and estuaries of the New York area. In L. I. S., one elver 56.90 mm long was taken on January 27, 1953 at St. 8; not only did it appear earlier than usual but it was larger than those previously taken by others during the spring. It may have been a product of earlier spawning.

Eels have been collected by Perlmutter, by Greeley, and by Warfel and Merriman in their surveys; they have also been taken with the oyster vacuum dredge in June. The commercial catch of eels from Connecticut rivers (12,700 pounds in 1951) varies little from year to year.

Enchelyopus cimbrius (Linnaeus); Four-bearded rockling.

The rockling inhabits areas of soft bottom from the Gulf of St. Lawrence to Cape Fear, N. C. and is usually found at depths of

¹ The specific name is listed in Ege's (1930) revision of the genus *Anguilla*.

25–800 fathoms (Bigelow and Schroeder, 1953). West of Cape Cod, where it is known to occur in depths of 5.5 to 9.0 fathoms, it has been recorded in abundance, in L. I. S. in the area from Bridgeport to Larchmont (early summer, 1914) and in Smithtown Bay (Nichols and Breder, 1926). However, it has been taken so seldom in trawl nets in this area that it is unfamiliar to commercial fishermen.

Spawning. Spawning may begin any time from late winter to late spring, depending upon the latitude. The depths at which eggs and larvae have been collected vary. Dannevig (1918) noted that the rockling spawned in May and June in shallow areas on the east coast of Canada. More recently in Europe, Mańkowski (1948) reported that eggs were found from May through July in the deeper regions of the Gdańsk Gulf, Poland; in this case the spawning location may have been limited by the lower salinity inshore. In the southern New England area, Perlmutter collected eggs in May and June and juveniles from May until October in widely separated places of varying depths down to 48 fathoms. Merriman and Sclar (1952) collected no eggs from B. I. S. at any time, and John Colton, aboard the ALBATROSS III (personal communication), found no evidence of spawning in B. I. S. or in the area 4–5 miles south of Long Island during the spring of 1953. However, Colton did collect eggs and larvae 20 miles south of Long Island and in numerous deeper areas to the eastward. In L. I. S. the eggs and larvae were collected from late winter through late spring 1952–1953 in areas where the depth varied from 8 to 60 m (4.4–32.8 fathoms).

Eggs. The eggs of the rockling ranked fourth in total abundance, and from March to mid-May they were more common than those of any other species. A total of 595 eggs (0.74–1.12 mm) was taken during this survey.

In 1952, 377 eggs were taken from March 13 to June 11, and in 1953, 206 eggs were collected between March 2 and June 1. In 1954 they were found as early as February 10. The height of the spawning season in 1952 occurred during May and in 1953 during April.

The water temperatures when they were collected were lower than 13° C, which Battle (1929) found was the minimum limit for normal egg development. Battle, as a result of studies of the effect of various temperatures and salinities on the developing egg, reported that normal development for this species took place between 13–19° at a wide range of salinities, 18.6–45.0‰. As would be expected,

the percentage of eggs that developed normally declined rapidly as unfavorable conditions increased. She also discovered that the spawning peak in Passamaquoddy Bay occurred when the temperature was 9–10° (1930). In L. I. S. the surface temperatures during which the eggs first appeared were: 1952–3.10°; 1953–3.40°; and 1954–1.15°; at the end of the spawning season the warmest surface temperatures were: 1952–16.10°; 1953–13.85° C. During these times there was little temperature gradient. The rockling appeared to stop spawning in this area as the temperature of the water column approached the 13–19° optimum limit reported by Battle. The peak of spawning in L. I. S. occurred at temperatures of 8–9° in 1952 and of 6–8° in 1953.

Eggs occurred at all of the regularly sampled stations and at many of the 100- and 300-cruise (April, 1953) stations. At the regular stations, more eggs were collected at Sts. 1 and 5 than at 2 and 8, perhaps due to the more westerly position of Sts. 1 and 5. Supplementary data (see Table VI) from the long cruises suggest that the

TABLE VI. REGIONAL ABUNDANCE OF *E. cimbrius* EGGS† IN L. I. S. FROM MARCH 1952 THROUGH JUNE 1953

Eastern End		Central Portion		Western End*	
St.	Eggs/m ³	St.	Eggs/m ³	St.	Eggs/m ³
117	0.11	101	0.44	128	0.12
313	0.11	103	0.55	129	0.45
314	0.26	105	0.34	130	0.37
316	0.33	107	1.02	131	0.75
318	0.20	305	2.64		
320	0.09	309	0.57		
			1952 1953		
		1	1.09 0.68		
		2	0.57 0.49		
		5	1.39 1.19		
		8	0.64 0.16		

† No eggs taken at unlisted stations.

* Inclement weather prevented collections during the second half of the 300-cruise to the western end of the Sound.

rockling spawned more heavily in the western and central regions than in the eastern end of the Sound.

From an analysis of egg measurements of nearly every collection (Table VII), the monthly averages of egg diameter and size range for 1952 are nearly equal to those for 1953. However, a decrease in diameter was noted as each spawning season advanced. The recorded

TABLE VII. SUMMARY OF MEASUREMENTS OF *E. cimbrius* EGGS FROM L. I. S. FROM MARCH 1952 THROUGH MARCH 1954

Date	Eggs				Oil Globules			% eggs with 1 oil glob.
	No. meas.	Range	Av. diam.	Stand. dev.	No. meas.	Range	Av. diam.	
1952								
Mar.	63	0.88-1.12	0.95	.039	113	0.05-0.30	0.15	36.7
April	106	0.82-1.00	0.92	.040	172	0.10-0.25	0.15	64.0
May	163	0.75-0.95	0.84	.042	206	0.05-0.28	0.14	74.0
June	45	0.74-0.93	0.82	.037	52	0.05-0.22	0.15	90.0
1953								
Mar.	30	0.79-0.99	0.93	.040	21	0.18-0.30	0.22	41.0
April	120	0.83-1.00	0.92	.036	55	0.14-0.25	0.18	75.0
May	19	0.76-0.89	0.84	.022	114	0.11-0.28	0.16	73.0
June	8	0.81-0.85	0.83	.010	40	0.12-0.22	0.16	87.0
1954								
Feb.	3	1.00-1.05	1.01	.019	—	—	—	—
Mar.	9	0.90-1.03	0.97	.035	—	—	—	—
Totals								
1952	377	0.74-1.12	0.88	.037	543	0.05-0.30	0.15	—
1953	177	0.76-1.00	0.91	.033	230	0.11-0.30	0.17	—

decrease is large enough to be important in any future identification of these eggs.

Shrinkage of the eggs (see DISCUSSION, p. 307) may be related to the length of time they are preserved before being measured, but in all probability other factors are more influential. In the case of the rockling, eggs taken from March through May 1952 and from March through June 1953 were measured 6-8 months after they were preserved whereas those taken in June 1952 during the 100-cruise were measured 15 months after preservation; measurements indicate that shrinkage had been uniform regardless of the time interval between preservation and measurement. A few of the March through June 1953 eggs were measured again after 12 to 16 months preservation, and they showed varying amounts of further shrinkage. During the spring of 1954, rockling eggs from special tows were immediately measured after preservation, after which they were put aside for comparative measurements at the end of 6 and 12 months. It appears that the greatest amount of shrinkage occurs within the first six months, but final results await further investigation.

Larvae. Eight larvae (2.00-4.90 mm) were taken in 1952-1953. Six were collected between May 1 and June 5, 1952, one on April 9, 1953, and one on April 15, 1953. The numerical ratio of rockling

larvae and eggs was low when compared to that of either menhaden or anchovy. In 1952 this ratio was 1:63, in 1953 1:103. Possibly mortality during development is higher in the rockling than in that of the other two species.

According to Battle, incidence of abnormal development of the larvae, as indicated by contorted bodies and enlarged pericardial cavities, increased below 13°. As seen in Table VIII, most of our larvae were taken in water less than 13.0°, but only one abnormality was noted, that being an enlarged pericardial cavity in the larva from St. 8 (May 1, 1952).

TABLE VIII. SUMMARY OF ABUNDANCE AND SIZE OF *E. cimbrius* LARVAE FROM L. I. S. IN 1952-1953

Date	St.	No. larvae	Length	Surf. temp. °C.
1952				
V-1	8	1	2.35	8.80
V-8	5	1	3.50	10.45
V-21	5	1	4.90	11.57
VI-4	107	1	2.00	16.20
VI-5	113	1	2.90	16.00
VI-5	118	1	3.50	14.20
1953				
IV-9	320	1	2.35	7.80
IV-15	1	1	2.40	6.50

Battle also reported that larvae from Passamaquoddy Bay developed normally in salinities of 20 to 40‰. All of the L. I. S. specimens were taken from waters having salinities well within that range except for one taken at St. 113 (June 5, 1952), where the salinity was below 20‰; this specimen appeared to be normal. Separation of the effect of salinity and temperature on development is probably unrealistic when dealing with organisms not raised under experimental conditions. Our observations indicate that larval growth up to 4.80 mm will proceed normally in L. I. S. at temperatures below 13° and at the usual spring salinities.

Knowledge of growth and habits of young rockling is limited. Huntsman (1922) reported rockling of all sizes throughout the year in the Bay of Fundy from six fathoms (St. Mary's Bay) to considerable depths. Bigelow and Schroeder assumed that the young became demersal after a few months of pelagic life, at a length of 40-45 mm, since longer ones were never found in their plankton tows from the Gulf of Maine. Sumner, *et al.* (1913) reported ten juveniles about

1.5 inches (40 mm) long for April (1906) from the bottom of shallow water at Woods Hole, Mass. Perlmutter (1939) collected larvae and juveniles as large as 29 mm from May to July in his plankton tows from all regions of L. I. S. except the central portion; from July through October he took 75–219 mm specimens from bottom or near-bottom of the Huntington Bay-Coldspring Harbor area, near the region where the 1914-group was taken. It is of interest to note that he collected no individuals between 29 and 75 mm. Evaluation of early growth rates in the Sound is difficult because the age at various lengths is unknown and because collections of various length groups were inadequate. However, it appears that rockling reach a size of 75–80 mm in the first year and up to 200 mm or more by the end of the second year; juveniles spawned in shallow water may remain there a year or two before retiring to deeper water.

The rockling is the only member of the Gadidae which was taken in this survey. However, eggs and larvae of other species such as *G. morrhua*, *M. bilinearis*, and *Urophycis* spp. were collected by Merriman and Sclar from northeastern B. I. S., and *P. virens*, *M. aeglefinus*, and *E. cimbricus* were collected by Perlmutter in B. I. S. and south of Long Island. Juveniles of pollack, whiting, squirrel hake, and tomcod have been taken in L. I. S. with beach seine, oyster vacuum dredge, and Griek trawl. From the limited information available, the Sound appears to be a nursery but not a spawning ground for some gadids.

Syngnathus peckianus Storer; Pipefish

This species, a common resident of the shallow waters of L. I. S., has been found in abundance in many different localities by Greeley, by Perlmutter, and by Warfel and Merriman.

One postlarva (10.9 mm long) which had recently abandoned its parent was collected at St. 5 on July 8, 1952.² The postlarvae obviously lead a pelagic existence since they do not appear in the sublittoral zone until they are nearly 30 mm long (Warfel and Merriman, 1944; Merriman, 1947).

² Warfel and Merriman felt that the breeding season did not begin as early as March, as indicated by Bigelow and Welsh (1925), since they found no spawning individuals earlier than June. Of the pipefish taken aboard the oyster vacuum dredge from the Lighthouse Point area in New Haven Harbor on May 3, 1954, the mature females had nearly fully developed roe but were not ready to spawn whereas all mature males had empty brood pouches.

Menidia menidia notata (Mitchill); Silversides.

This species is a permanent resident and spawns from May until mid-July. Both postlarvae and juveniles have been collected previously in L. I. S., but since it usually remains in brackish, shallow weedy areas, few would be expected at our station locations.

One postlarva (5.3 mm long) was taken at St. 5 on June 24, 1952. Hildebrand (1922) claimed that only by its larger size at hatching and faster development in respect to size could the larvae of *M. m. notata* be distinguished from that of *M. beryllina cerea*. Since the latter is less abundant in this area, inhabits mostly fresh and brackish water, and would not be as well developed as *M. m. notata* at 5 mm, our L. I. S. specimen has been identified as *M. M. notata*.

Although Bigelow and Schroeder postulated that silversides require a temperature of 20° C for successful reproduction, the data from our own observations and from those of Perlmutter and of Warfel and Merriman suggest that *M. m. notata* reproduces successfully at 15° or lower.

Cynoscion regalis (Bloch and Schneider); Weakfish.

The weakfish, a consistent summer immigrant, appears at the eastern end of the Sound in May and in the central and western portions in June. However, it does not approach its peak of abundance until early July.

Spawning. According to our data this species spawned in 1952 from early June until late August and in 1953 from mid-July to mid-August. During the 100-cruise in June 1952 the eggs were found to be widely scattered throughout the Sound (see Fig. 1).

Eggs. In 1952, 93 eggs were taken between June 4 and August 26, with the peak of abundance in early June. In 1953, 30 eggs were collected between July 14 and August 11, with the peak near the end of July. These weakfish eggs were compared with Perlmutter's identified specimens and with material at the U. S. Fish and Wildlife Service Laboratory at Woods Hole. Unfortunately, we were not successful in our attempts to carry the eggs to the hatching stage under laboratory conditions.

Surface temperatures which coincided with these egg collections increased in 1952 from 13.80° C on June 5 at St. 115 to 22.70° at St. 5 on August 5. In 1953 the temperature range during spawning was well within the limits given for 1952. Although Sherwood and

Edwards (1901) reported that large adult weakfish appeared near Woods Hole when the temperature was only 10.0°, our data indicate that it does not spawn until the water is close to 13.0°. The combined salinity range for 1952 and 1953 was 18.40 to 27.73‰. Lower salinities in spring 1953 may have been partially responsible for the later appearance of eggs in that year.

Although the eggs were fairly well distributed throughout the Sound, more were collected during the 100-cruise (see Table IX) from central regions than from either eastern or western ends. Considering only the regular stations, slightly more eggs were taken at St. 2 during both years.

TABLE IX. REGIONAL ABUNDANCE OF *C. regalis* EGGS* IN L. I. S. IN 1952-1953

Eastern End		Central Portion		Western End	
St.	Eggs/m ³	St.	Eggs/m ³	St.	Eggs/m ³
115	0.08	103	0.37	131	0.47
117	0.11	105	2.05		
		107	0.36		
		109	2.69		
		111	0.26		
			1952	1953	
		1	0.12	0.13	
		2	0.18	0.40	
		5	0.08	0.07	
		8	0.00	0.04	

* No eggs were collected at stations not listed.

In Table X, which lists the egg diameter for each month during the spawning season of 1952 and 1953, it is seen that the diameter remained constant throughout the spawning season. Both average size and range were alike for each year and variation in the standard deviation was only 0.04 and 0.02 mm, a considerably smaller range of variation than has been given in the literature. Welsh and Breder (1923) and Pearson (Hildebrand and Cable, 1934) reported size ranges of 0.70-1.10 and 0.70-1.13 mm respectively, while Merriman and Sclar (1952) gave a range of 0.68-1.18 mm.

According to Welsh and Breder (1923), the size of eggs from two different weakfish varied markedly; Hildebrand and Cable (1934), basing their argument on a statement by Delsman (1931), pointed out that the eggs may have been raised in waters of unequal density, which might produce a difference in size; however, they also pointed out that a large variation in size under identical conditions might

TABLE X. SUMMARY OF MEASUREMENTS OF *C. regalis* EGGS FROM L. I. S.

Date	Eggs				Oil Globules				
	No. meas.	Range	Av. diam.	Stand. dev.	No. meas.	Range	Av. diam.	Stand. dev.	% with more than 1 globule
1952									
June	88	0.76-0.96	0.84	.041	109	0.11-0.30	0.21	.039	18
July	2	0.78-0.82	0.80	.028	3	0.15-0.20	0.18	.027	50
August	2	0.82-0.90	0.86	—	2	0.18-0.20	0.18	—	0
1953									
July	24	0.75-0.87	0.83	.015	38	0.05-0.24	0.16	.060	46
August	6	0.83-0.95	0.87	.027	8	0.12-0.24	0.17	.044	12.5
Totals									
1952	93	0.76-0.96	0.84	.040	114	0.11-0.30	0.21	.039	19.5
1953	30	0.75-0.95	0.84	.018	46	0.05-0.24	0.16	.057	40

suggest the presence of two races. The large size variation in eggs from B. I. S., as indicated by Merriman and Sclar, may suggest the presence of more than one race, and Perlmutter postulated that local races may exist in L. I. S., but the relatively uniform measurements and short spawning season observed by us in L. I. S. may indicate the presence of only one.

The weakfish egg contains from one to six oil globules, which vary in size primarily according to the number of globules in the egg. Note in Table X, for 1953, that an increase in the percentage of eggs with more than one oil globule is reflected in the generally smaller size of the globules. When only one globule was present its size varied between 0.18–0.25 mm (average 0.23 mm) with a standard deviation of about 0.02 mm. When more than one per egg was present the minimum globule diameter decreased as much as 0.13 mm; the smallest globule measured 0.05 mm.

Larvae. In 1952 seven larvae (2.1–4.1 mm long) were taken during July and in 1953 seven more (2.8–4.4 mm) were collected in July and August. Throughout the summer these larvae were taken more commonly than those of any other species except *A. m. mitchilli* and *T. adspersus*. In fact, the numerical ratio between larvae and eggs was 1:2.1 in 1952 and 1:4.3 in 1953. Since it is quite unlikely that the larvae of *C. regalis* were more easily caught in the plankton nets than those of other species, either the eggs were inadequately sampled or the larvae survived better than those of other species. Most of the larvae were taken at St. 8, none were taken at St. 1, and only a few were found at Sts. 2 and 5.

According to Perlmutter and Warfel and Merriman, juveniles which remain inshore increase in length to 100 mm by mid-October. Previous investigators have reported finding juveniles in river mouths, and Raney and Massman (1953) took them during the summer in a surface tow five miles upstream from brackish water in the Pamunkey River, Virginia where the salinity was less than 5‰ but where tidal influence was still apparent. Their possible occurrence in Connecticut rivers has not been investigated.

Menticirrhus saxatilis (Bloch and Schneider); Kingfish

A summer visitor like the weakfish, kingfish usually appear at the eastern end of L. I. S. in June and in the central portion in June or July. They remain in the area until mid-October, by which time most of them have begun their southward journey.

Spawning. In southern New England waters the kingfish spawns close to shore from June until August. Perlmutter collected kingfish eggs during June and July in Peconic-Gardiners Bay and in inlets near Moriches Bay, Long Island, which, according to Welsh and Breder (1923), are habitats preferred by spawning kingfish. Merriman and Sclar collected no kingfish eggs in their samples from B. I. S. Our data indicate that kingfish spawned at the inshore stations from early June until mid-July.

Eggs. In both years, 27 eggs (0.75–0.91 mm) were taken; in 1952 10 were taken between June 6 and July 15, and in 1953 17 were taken between July 7 and 21. All of them were collected at inshore Sts. 1 and 8 (see Table XI), and more might have been collected had the samples been taken from even shallower areas. At present, *M. saxatilis* appears to be one of the least abundant pelagic spawners of the area sampled.

Temperature and salinity ranges when these eggs were collected were small. For both years combined, the water temperature ranged from 17.00 to 22.75° C, the salinity from 24.79 to 26.71‰. On the basis of Perlmutter's data as well as our own, kingfish apparently do not spawn in water below 15°; more probably it waits until the temperature approaches 17°.

From measurements of all kingfish eggs collected (Table XI), it appears that a decrease in diameter occurred from June through July. The diameters agreed well with the range of 0.76–0.92 mm given by Welsh and Breder (1923).

Larvae. Only one larva, 3.7 mm long, was collected, that being taken at St. 5 on August 19, 1952. Although the last eggs in 1952 were collected on July 8, spawning undoubtedly persisted longer than our data indicate; Warfel and Merriman also felt that spawning continued beyond mid-July.

Stenotomus chrysops (Mitchill); Scup

During the last decade this species increased tremendously in commercial importance in the Connecticut and Rhode Island fisheries. Statistics show that in 1940 the Connecticut catch was only 485,700 pounds with a value of \$19,753, whereas in 1950 it was 1,573,900 pounds with a value of \$104,377. In Rhode Island the increase was even more striking: 1,398,700 pounds in 1940 (value \$22,521) to 4,467,000 pounds in 1950 (\$234,553). These data would indicate that either the commercial demand for scup increased during this

TABLE XI. SUMMARY OF THE RELATIVE ABUNDANCE AND SIZE OF *M. saxatilis* EGGS FROM THE REGULAR STATIONS IN L. I. S.

Date	Eggs			Globules			
	No. meas.	Range	Av. diam.	Stand. dev.	No. meas.	Range	Av. diam.
1952							
VI-6	1	—	0.91	—	7	0.06-0.08	—
VII-8	8	0.76-0.84	0.81	.030	6-20 (Av. 12)	0.07-0.12	0.10
VII-15	1	—	0.75	—	15	—	0.10 largest
1953							
VII-7	15	0.75-0.85	0.81	.030	8-22 (Av. 16)	0.06-0.14	0.09
VII-21	2	0.80-0.83	0.81	.020	15, 18	—	0.10 largest
	Eggs/m ³	St. 1	2	5	8		
1952	0.11	0.00	0.00	0.01			
1953	0.33	0.00	0.00	0.04			

decade or its abundance in southern New England waters had increased, or both.

This species, a summer visitor to this area, is found in water temperatures higher than 7.2° C; it usually arrives in mid-spring and departs in October or November.

Spawning. The scup is a summer spawner. Perlmutter's samples from the vicinity of Long Island contained scup eggs from May until August. Our egg collections from L. I. S. proper indicate shorter spawning periods, from the end of May to the end of July and from the beginning of June to the first week of July in 1952 and 1953 respectively.

Eggs. In 1952, 172 eggs were collected from May 29 to July 22, and in 1953, 37 eggs were taken between June 1 and July 7, giving a total of 209. Their size range was 0.85 to 1.15 mm. The number of eggs per cubic meter in 1952 was nearly three times greater than that in 1953.

Since the scup is demersal, seldom rising far off the bottom (Bigelow and Schroeder), its spawning habits would be influenced more by bottom than by surface temperatures. But, since the eggs rise when laid, they would be affected more by surface temperatures. Therefore, both bottom and surface temperature ranges are listed. In 1952, bottom temperatures from the end of May until July 22 ranged between 10.10 and 17.80° while those at the surface varied from 13.30 to 22.75° C. In 1953, bottom temperatures during the spawning period ranged from 11.25° to 17.25°, while those at the surface were 13.45 to 20.70°. Though taken occasionally in water below 11°, scup eggs are not often found until the bottom temperature has risen above this point.

When data from all of L. I. S. is broken down into regional groupings, as in Table XII, it is seen that *S. chrysops* eggs were present only in the eastern and central portion of the Sound, particularly in the latter; no eggs were collected west of Long. 73° 04' W, that is, west of a line from Port Jefferson, Long Island to Bridgeport, Conn. (See Fig. 1). Of the regularly visited stations, scup eggs were most abundant at St. 8. The greater number of eggs at this Station and at St. 2 as well may be due to the more easterly positions of these two stations. Perlmutter recorded no eggs west of Long. 73° 12' W, but he did find a large quantity in Peconic-Gardiners Bay and eastward to Southwest Ledge off Montauk Pt. Since it is believed that most

adult scup spawn on this coast in relatively shallow water, it seems strange that Merriman and Sclar found none in northeastern B. I. S.

Identification of these eggs was difficult for two reasons, first, because of the similarity between eggs of *S. chrysops* and *M. bilinearis*, and second, because of the discrepancies in the literature and in our data concerning the size of these eggs. Scup and whiting not only spawn during the same seasons but produce eggs which appear similar, with an overlap in size of both egg and globule. However, once the embryo is well developed there is less difficulty; although the dorsal side of the head in these two species has similar pigmentation, the whiting embryo has a distinct black vertical band located across

TABLE XII. REGIONAL ABUNDANCE OF *S. chrysops* EGGS FROM L. I. S. IN 1952-1953
NONE WERE TAKEN FROM THE WESTERN END

Eastern End		Central Portion	
St.	Eggs/m ³	St.	Eggs/m ³
113	0.17	101	0.09
115	1.00	107	0.22
117	0.68	109	2.54
118	0.18	111	0.17
119	0.58	123	3.36
121	0.47	125	0.38
		126	0.22
			1952 1953
		1	0.06 0.06
		2	0.28 0.13
		5	0.05 0.09
		8	0.93 0.44

its caudal end from one-half to one-third of the distance from the tip of the tail to the vent; this is lacking in scup embryos. No eggs of *M. bilinearis* were collected in L. I. S.

Regarding discrepancies in egg size, Kuntz and Radcliffe (1917) recorded a range of 0.85-0.90 mm for scup taken at Woods Hole, and Perlmutter gave measurements of 0.80-0.96 mm for his 66 scup eggs. Our collections, however, show a range of 0.85-1.15 mm. In view of the larger size of our eggs, their identification was checked against those obtained from stripped fish taken in a fish trap near Quisset Harbor at Woods Hole (see Table XIII for pertinent data). The eggs obtained at Woods Hole were taken on two different dates and were preserved in three different strengths of formalin. No apparent difference in egg size was caused immediately by the different concentrations of formalin, but future measurements of these same

eggs are contemplated to ascertain whether the combined effect of time and formalin concentration will cause shrinkage. The average diameter of the eggs from Woods Hole was greater than the maximum given by Kuntz and Radcliffe, but it was slightly less than that of our 1952 eggs and about equal to that of our 1953 eggs. Since the eggs were stripped and fertilized prior to natural spawning, they may have been smaller than they would have been normally, and furthermore, they may have had less time to absorb the water from their surroundings. Oil globules from the stripped eggs ranged from

TABLE XIII. COMPARISON OF THE SIZE OF *S. chrysops* EGGS OBTAINED AT WOODS HOLE, MASS. AND PRESERVED IN THREE DIFFERENT CONCENTRATIONS OF FORMALDEHYDE IN 1954

	Percent formalin		
	3	5	10
June 21			
N. meas.	—	—	50
Range	—	—	0.89-0.99
Av. diam.	—	—	0.94
Stand. dev.	—	—	.024
June 30, and July 2			
Eggs			
No. meas.	12	12	14
Range	0.92-0.96	0.89-0.95	0.90-0.96
Av. diam.	0.94	0.93	0.93
Stand. dev.	.01	.017	.022
Oil Globules			
No. meas.	12	13*	14
Range	0.16-0.20	0.10-0.20	0.16-0.20
Av. diam.	0.18	0.18	0.18
Stand. dev.	.018	.018	.014

* One egg with two oil globules.

0.10-0.20 mm and averaged 0.18 mm. Usually only one globule was present in a single egg.

As shown in Table XIV, the average size of the L. I. S. scup eggs was 0.99 mm in 1952 and 0.93 mm in 1953, and the average size of the oil globule was 0.22 mm. Little decrease in egg diameter was noted throughout either spawning season.

Larvae. Two recently hatched larvae (3.00 and 3.05 mm long) were taken on July 1 and 15 at St. 2. On July 7 and 21, 1953, two more (2.50 and 3.20 mm) were taken at St. 8. Merriman and Sclar found only one larva in B. I. S. (in July). Larvae and juvenile scup are rarely mentioned in the literature on L. I. S. though taken in numbers from Peconic-Gardiners Bay and along the south shore of

TABLE XIV. SUMMARY OF MEASUREMENTS OF *S. chrysops* EGGS FROM L. I. S. IN 1952-1953

Date	Eggs				Oil globules			
	No. meas.	Range	Av. diam.	Stand. dev.	No. meas.	Range	Av. diam.	Stand. dev.
1952								
May	1	—	0.95	—	1	—	0.28	—
June	156	0.85-1.15	1.00	.047	153*	0.18-0.27	0.23	.017
July	9	0.90-0.98	0.95	.006	9	0.15-0.23	0.19	.010
1953								
June	15	0.91-1.10	1.00	.025	16†	0.16-0.25	0.21	.028
July	21	0.85-0.96	0.92	.030	21	0.14-0.22	0.20	.022
Total								
1952	166	0.85-1.15	0.99	.045	163	0.15-0.28	0.23	.017
1953	37	0.85-1.10	0.93	.030	38	0.14-0.25	0.20	.027

* 3 oil globules were squashed.

† 2 eggs had 2 oil globules apiece.

Long Island. Larval development may not be successful in the two Sounds, but more likely juveniles, not abundant in the previously sampled shore-line communities, remain in deeper water or migrate from the Sound during late summer.

Tautogolabrus adspersus (Walbaum); Cunner
Tautoga onitis (Linnaeus); Tautog

These two species are considered jointly because the eggs are nearly identical in appearance and occur at approximately the same time and location. Both species are common residents of L. I. S., particularly in water of less than 10 fathoms. The cunner frequents pilings, floats, and eel grass (*Zostera*) during summer, and the tautog haunts mussel beds and particularly rocky places such as breakwaters and reefs.

Spawning. The spawning season of the cunner is sometimes more prolonged than that of the tautog, as in 1952 in L. I. S., when our observations confirmed those of Perlmutter. In 1953, however, the spawning season of these two species was essentially the same, apparently due to a shorter spawning season of the cunner. Cunner eggs were taken in 1952 from mid-May until the second week of October while tautog eggs, initially found on the same day, were taken until mid-July only. In 1953, eggs of both species were found from the end of May until mid-August.

Eggs. A total of 2,105 cunner eggs (0.76-1.03 mm) and 340 tautog eggs (0.91-1.15 mm) were taken in the two years (Table II): in 1952,

848 cunner eggs between May 21 and October 8, 211 tautog eggs from May 21 to July 15; in 1953, 1,257 cunner eggs and 129 tautog eggs between May 25 and August 18. In abundance, cunner eggs were second only to those of *A. m. mitchilli*.

Although Johansen (1925) found cunner eggs in the Gulf of St. Lawrence in water of 4.79° C, Perlmutter took them at a minimum of only 7.89°. In L. I. S., neither cunner nor tautog eggs were taken at temperatures below 10.01°. In 1952 and in 1954 they were taken when the water reached 10°, but in 1953 they were taken 10 days after the water reached this temperature. Some other factor may have caused this 10-day difference. Possibly it was due to a lower salinity that resulted from heavy precipitation in 1953.

Both cunner and tautog spawned throughout the entire Sound (see Fig. 1, Table XV). According to the 100-cruise data, the cunner spawned more heavily at the western end than at either the central or eastern portions of the Sound, and furthermore, it spawned more heavily in all regions than did the tautog. The spawning of the tautog at the western end of the Sound was almost as great as that at the eastern end, but in the central area it was considerably less than that at either end. The data from the regular stations confirm the opinion that both species tend to be inshore spawners, the cunner more so than the tautog. The fluctuations in egg abundance at the stations were notable, as indicated by a ten-fold increase of cunner eggs at St. 2 in 1953.

The annual variation of these species (see Table XV) was of the same order of magnitude as that of weakfish, scup, kingfish, and menhaden, but it was less than that of the anchovy and greater than that of the rockling. Greater variation in egg abundance is expected among schooling species, but such was not always the case. Whereas menhaden and anchovy are schooling forms, cunner and tautog are semischooling, but cunner egg collections sometimes fluctuated as much as those of the anchovy. While less eggs of menhaden, anchovy, rockling, et al. were taken in 1953 than in 1952, less eggs of the cunner were taken in 1952 than in 1953. It appears that the number of eggs of this shallow water fish at any one station does not depend on variations in surface movements produced by differences in prevailing winds and recognized by changes in the inshore horizontal density gradient (see Riley's PHYSICAL OCEANOGRAPHY in this issue). In 1952, when there was considerable offshore water movement, more eggs

TABLE XV. REGIONAL ABUNDANCE OF *T. adspersus* AND *T. onitis* EGGS AND LARVAE FROM L. I. S. IN 1952-1953

EGGS								
Eastern End			Central Portion			Western End		
St.	<i>T. adspersus</i> Eggs/m ³	<i>T. onitis</i> Eggs/m ³	St.	<i>T. adspersus</i> Eggs/m ³	<i>T. onitis</i> Eggs/m ³	St.	<i>T. adspersus</i> Eggs/m ³	<i>T. onitis</i> Eggs/m ³
113	0.00	0.26	101	1.77	0.71	128	1.57	0.96
115	0.08	0.92	103	0.09	0.00	129	3.28	1.19
117	0.79	0.45	105	0.00	0.09	130	3.68	0.62
118	5.97	2.59	107	0.00	0.07	131	4.34	1.31
119	0.86	0.48	111	0.86	0.17	241	0.09	0.00
121	1.16	0.35	125	0.89	0.76			
			126	10.44	0.55			
Total	1.58	0.95	Total	1.84	0.17	Total	3.24	0.73

	1952	1953	1952	1953
1	1.1	1.6	0.72	0.22
2	0.11	1.1	0.00	0.21
5	0.14	0.11	0.04	0.00
8	4.5	8.5	0.36	0.90

LARVAE

<i>T. adspersus</i>		<i>T. onitis</i>	
1952	No.	Size mm	1953
St. 1	6	2.7-3.5	—
2	1	2.4	—
5	0	—	—
8	1	2.5	—
241	1	2.8	—
243	1	2.5	—
244	1	2.7	—
1953			
St. 1	2	3.2-3.8	—
2	2	3.1-4.6	—
5	0	—	—
8	1	2.7	1

were collected at St. 1 (inshore) than elsewhere, while in 1953, when there was less offshore movement, more eggs were taken at St. 2 (offshore). However, at St. 8 (inshore) twice as many eggs were taken in 1953 than at the same station in 1952. No definitive explanation for differences in egg abundance between 1952 and 1953 has been ascertained.

Until the embryo is developed, size is the only criterion by which the eggs of these two species may be distinguished. Previous workers have recorded a considerable range in diameter for cunner and tautog eggs. Kuntz and Radcliffe reported that living eggs of the cunner from Woods Hole ranged from 0.75 to 0.85 mm and those of the

tautog from 0.90 to 1.00 mm. For stripped cunner eggs from Peconic Bay, Perlmutter obtained a range of 0.84-1.00 mm and an average of 0.96 mm; for 106 naturally spawned tautog eggs, the range was 1.00-1.20 mm. Merriman and Sclar collected only cunner eggs in B. I. S., the majority of which varied between 0.75 to 0.85 mm, with some as large as 1.30 mm. They assigned the largest eggs to the cunner rather than the tautog because the eggs of two different species in the same haul would not be consistently in the same stage of development and because more cunner larvae were collected. In L. I. S., the cunner egg diameters (see Table XVI) were smaller than those given by

TABLE XVI. SUMMARY OF MEASUREMENTS OF *T. adspersus*(A) AND *T. onitis*(O) EGGS FROM L. I. S. IN 1952-1953

Date	No. meas.		Range		Ar. diam.		Stand. dev.	
	A	O	A	O	A	O	A	O
1952								
May	106	26	0.82-0.95	1.01-1.14	0.90	1.09	.028	.041
June	475	148	0.76-1.03	0.95-1.14	0.87	1.04	.032	.030
July	131	4	0.75-1.00	0.92-0.99	0.84	0.95	.050	.035
Aug.	12	0	0.81-0.93	—	0.84	—	.075	—
Sept.	1	0	—	—	0.81	—	—	—
Oct.	1	0	—	—	0.84	—	—	—
1953								
May	26	16	0.86-0.95	1.01-1.15	0.91	1.09	.028	.033
June	113	47	0.78-0.95	0.97-1.14	0.88	1.05	.033	.033
July	110	5	0.76-1.00	0.94-1.02	0.84	0.99	.046	.025
Aug.	21	3	0.78-0.85	0.91-0.98	0.82	0.94	.020	.036
Totals								
1952	726	178	0.76-1.03	0.94-1.15	0.86	1.05	.050	.030
1953	270	71	0.76-1.00	0.91-1.15	0.86	1.05	.040	.030

Perlmutter but they agreed well with the figures of Kuntz and Radcliffe. Possibly the difference between Perlmutter's measurements and ours is due to the presence of two races of cunners. The mean diameter and range of tautog eggs in L. I. S. were greater than the figures given by Kuntz and Radcliffe but were similar to those of Perlmutter.

Table XVI shows that there is considerable overlap in the size range of the eggs of these species. In May and June the size difference was sufficient for distinction, but in July and August, the critical months, the egg size was similar enough so that clear-cut differentiation was difficult. During the first two weeks of July, the number of tautog eggs between 0.90-1.00 mm increased from 15 to 80% of the total number of tautog eggs, whereas the number of cunner eggs

in this range, originally 15% of the total number of cunner eggs, decreased to 10%. Thus, the overlap at this size range was much greater in July and August than at any earlier time of the year. Also, in July and August 1952 a few large eggs were listed as cunner (Table XVI). In 1952, relative to June, the standard deviation increased in July and August, particularly so in the latter month, which indicates that either the variation in egg size increased greatly or the eggs were incorrectly identified. However, although the standard deviation in July 1953 was greater than that in June 1953, it was less than that of July 1952; in August 1953 it decreased relative to August 1952 and July 1953. In further investigation of this question, two unpreserved tows from Sts. 1 and 3 on July 8, 1954 were examined. It was found that larvae of the tautog hatched from the larger eggs and of the cunner from the smaller ones. It was concluded that: (1) difficulty in separation may have been partially responsible for such a large standard deviation in cunner egg measurements in July and August; (2) the larger eggs found by Merriman and Sclar (those over 1.00 mm) may have been tautog eggs or they may have been cunner eggs from a group in B. I. S. and Peconic Bay which normally produces larger eggs. On the basis of our present data, the presence of more than one race of cunners cannot be postulated for L. I. S.

Larvae. In all collections, only one tautog larva (2.5 mm) was taken, that at St. 8 on July 21, 1953, whereas 16 cunner larvae were taken from the regular stations and from three stations at the western end of the Sound: 11 (2.4–3.5 mm) in 1952 between August 12 and October 9 (Table XV) and 5 (2.65–4.6 mm) in 1953 between July 7 and 28. The numerical ratio of cunner larvae to eggs was 1:77 in 1952 and 1:257 in 1953.

In 1952, surface temperatures where cunner larvae were found ranged from 22.80° at St. 2 on August 12 to 19.10° C at St. 243 on October 9. The surface salinity during this period varied between 27 and 30‰.

According to reports, juvenile cunners in this area, probably attaining a size of 40–45 mm by autumn (Johansen, 1925), are widely distributed but only moderately common in beach seine hauls. On the other hand, the tautog is taken more commonly with this gear and is 15–48 mm by August. As to their whereabouts, Baird (1855) presumably found juvenile tautogs in New Jersey rivers; Bean (1903) and Johansen (1925) reported that juvenile cunners 1–2 inches long

prefer sandy bottoms near shallow river mouths. Gunter (1942) reported neither species as occurring in both fresh or sea water. Juveniles of these two species in L. I. S. may not prefer a salinity much lower than that found near river mouths in the spring.

Ammodytes americanus De Kay; Sand eel

This species, a permanent resident of L. I. S., is demersal. Greeley found that adults prefer the sandy or gravelly beaches of the north shore of Long Island to those of the south shore. This species was taken in neither the beach seine hauls at Morris Cove nor in the oyster dredge.

Spawning. On the east coast of North America the sand eel spawns from Canada to Virginia; south of Cape Cod its spawning is limited to the inner half of the continental shelf and to regions where the bottom temperature is 9° C or lower (Sette, unpubl.). The exact time of spawning has not been determined, but postlarvae have been taken from January to March in the Gulf of Maine (Bigelow and Schroeder) and from March to May at Woods Hole (Sumner, *et al.*, 1913). In L. I. S. the larvae were taken from December to May. As in the case of the European sand eel, the eggs are probably demersal, which may account for their absence in the L. I. S. collections. Estimates of the initial occurrence of spawning of the American species is therefore deduced from studies of the speed of growth of the embryo and larva of the European sand eel.

Ehrenbaum (1909), quoted by Einarsson (1951), has given the only estimate of embryonic development time. According to Ehrenbaum, the spawning of *A. tobianus* occurs in autumn at about 20 m depth; the eggs are submersal and stick to sand grains on the bottom. Some larvae emerge in autumn, but the majority do not appear until early the following year, from January–March. According to our data, spawning in L. I. S. starts during the last two weeks of November, or earlier, and continues to mid-February or March.

Eggs. None.

Larvae. A total of 506 larvae, ranging in length from 3.10–33.5 mm, were collected in L. I. S. in 1952–1954. In 1952, 343 were taken between March 5 and April 21, 87 were collected between December 15, 1952 and May 13, 1953, and 76 between December 9, 1953 and April 27, 1954. The peaks of abundance occurred in March of 1952 and 1953 and in January–February 1954 (Table I). Compared

with other species in our collections, *A. americanus* ranked second in relative abundance; only *A. m. mitchilli* were taken in greater quantity. By May the larvae had disappeared, presumably to the bottom in shallower areas.

The temperature of the water column in L. I. S. at the time of the initial appearance of the larvae, during the first two weeks of December, ranged from 10.05–7.75° C. These figures agree fairly well with those recorded by Sette (unpubl.) and Einarsson (1951) for the first appearance of larvae of *A. americanus* and *A. lancea lancea* farther offshore in northeastern North America and Iceland respectively. In 1953, temperatures in L. I. S. in early December were higher, between 10.80–8.25°. Despite small temperature fluctuations,

TABLE XVII. REGIONAL ABUNDANCE OF *A. americanus* LARVAE IN L. I. S. IN 1952–1954
NONE WERE TAKEN AT THE EASTERN END

Central Portion		Western End	
St.	Larvae/m ³	St.	Larvae/m ³
303	0.19	422	0.24
403	0.11		
418 (I–IV)	0.37		
518	0.07		
	1952	1953	1954
1	0.27	0.04	0.16
2	2.30	0.13	0.10
5	2.70	0.25	1.20
8	0.32	0.03	0.03

larvae were taken in L. I. S. two to three weeks after the initial occurrence of positive temperature gradients in the fall, and spawning terminated in spring at about the time thermal stability was established. In 1953 spawning seems to have come to an end somewhat earlier.

The salinity tolerance of *A. americanus* is not known. In L. I. S. the salinities during the first two weeks of December in 1952 and 1953 varied between 27.98–28.76‰ but in April the larvae encountered salinities as low as 24.18‰.

Larvae were found more abundantly in the central portion of the Sound than in the eastern and western ends (Fig. 1, Table XVII). During the 300-cruise to the eastern area in April 1953, no larvae were taken except at St. 303, near St. 2. During the second half of the 400-cruise to the western end in April 1954, only two were taken at St. 422 off S. Norwalk. By far the greatest number was collected

at the regular offshore stations where the depth is more than 15 m. Though reported to spawn at 10 fathoms, it appears that sand eels do spawn in shallower water.

The number of larvae taken at the regular stations in March–April 1952 far exceeded those taken from December–May in either 1953 or 1954. Such fluctuations may be partially understood when it is considered that sand eels form huge schools which probably move about and spawn at different localities.

The lengths of 462 larvae ranged from 3.1 with yolk sac to 33.5 mm with fins almost completely differentiated. Table XVIII presents the distribution and abundance of size categories after the method of Einarsson: 1–4, 5–9, 10–14, . . . 30–34 mm. A majority of the larvae were in the 10–14 mm size, with the 5–9 mm category a close second. When seasonal size progression is considered, variations between the different years are noted. In March 1952 our collections included a few short larvae of a size not collected later than January in subsequent years; this would seem to indicate either slower embryonic development, delayed spawning, or a prolonged spawning season in 1952. In March–April 1953 we found only the larger larvae which were not taken before January, although, as indicated earlier, larvae first appeared in the collections during the second week of December; the presence of only larger larvae in March–April indicates either rapid development or a shorter spawning season in 1953 than in 1952.

From December–May the average length increased about 3–5 mm a month, but this figure is not a measure of the actual growth rate, first, because any noticeable increase is always influenced by newly hatched individuals that enter the older population, and second, because growth may be exceedingly uneven and significantly varied in the different months due to various factors such as water temperature, etc. The decrease in percentage of those in the larger size categories (Table XVIII) implies that the sand eels either migrate to an unsampled area, show a greater ability to escape the net at increasing sizes, or suffer an increasing mortality at the larger sizes. If the larvae grow as slowly as it appears, then they are probably subject to a high degree of predation throughout their entire early growth rather than at just one stage. Hence, net escapement probably accounts in large measure for the decrease in percentage of larger larvae as compared with those of the 5–9 mm group.

TABLE XVIII. NUMBER AND PERCENTAGE OF *A. americanus* LARVAE BY MM SIZE CATEGORIES DURING EACH MONTH OF THE SPAWNING SEASON IN L. I. S. FROM 1952-1954

Date	1-4	5-9	10-14	15-19	20-24	25-29	30-34
1952							
Mar.	5 2%	69 28%	123 49%	50 20%	2 0.8%	0 0%	0 0%
Apr.	0 0%	15 28%	18 34%	13 25%	6 11%	1 2%	0 0%
Dec.	0 0%	3 100%	0 0%	0 0%	0 0%	0 0%	0 0%
1953							
Jan.	0 0%	5 63%	3 37%	0 0%	0 0%	0 0%	0 0%
Feb.	0 0%	0 0%	6 86%	1 14%	0 0%	0 0%	0 0%
Mar.	0 0%	0 0%	7 50%	7 50%	0 0%	0 0%	0 0%
Apr.	0 0%	0 0%	1 25%	3 75%	0 0%	0 0%	0 0%
May	0 0%	0 0%	0 0%	0 0%	0 0%	0 0%	1 100%
Dec.	6 13%	41 87%	0 0%	0 0%	0 0%	0 0%	0 0%
1954							
Jan.	1 5%	10 50%	9 45%	0 0%	0 0%	0 0%	0 0%
Feb.	0 0%	12 36%	18 55%	3 9%	0 0%	0 0%	0 0%
Mar.	0 0%	2 13%	3 19%	5 31%	4 25%	0 0%	0 0%
Apr.	0 0%	0 0%	2 40%	0 0%	3 60%	0 0%	0 0%
Total	462 3%	157 34%	193 42%	83 18%	15 3%	1 0.2%	1 0.2%

Sette (unpubl.), following an observation by Russell (1926) that the larger larvae migrate diurnally, found that the total ratio of *A. americanus* larvae in surface waters to deeper layers over the continental shelf was 18-1 and that many more were at the surface at night than during the day. However, he observed no depth preferences associated with larval size. In L. I. S. six tows with closing nets at two levels were taken March 30, 1954, and, although few larvae were collected, the results indicate that the sand eel, while preferring the surface, was present in the entire water column both day and night. It seems likely that daylight escapement is a more important variable

than diurnal migration, as in the case of Silliman's (1943) results with *Sardinops caerulea*.

The relationship between the American and European sand eels has never been completely established, but the spawning seasons, larval development, and vertebral numbers of *A. americanus* and the lesser sand eels (*A. lancea*-group) of Europe and Iceland are sufficiently similar to warrant consideration of *A. americanus* as a subspecies. Einarsson (1951) found that 57 larvae of *A. lancea lancea (tobianus)* over 20 mm in length, taken in Icelandic waters, had a mean vertebral count of 63.03 while all other Icelandic species had over 69. Six larvae from L. I. S. had an average vertebral count of 62.67.

Scomber scombrus Linnaeus; Mackerel

Spawning. Merriman and Sclar collected mackerel eggs in B. I. S. in April-June, and Sette (1943), in discussing its spawning localities, wrote that ". . . as far as is now known, no spawning takes place in the enclosed bays and sounds west and south of Block Island." However, we collected a small number in L. I. S. in May and June, hence there is at least a limited amount of spawning within this area, since it is highly unlikely that the eggs in our collections were transported from B. I. S. The net transport of bottom water is slower than the period of egg development.

Bigelow and Schroeder indicated that mackerel do not converge on special breeding grounds but spawn wherever they happen to be. It is likely then that some are present in the Sound at the time of spawning, though the number is probably quite limited and would not attract the attention of commercial fishermen as in B. I. S.

Eggs. Eight were collected in the first week of June in 1952 between Sts. 101 (1) and 113; only one was taken in 1953, at St. 2 on May 13.

The water temperatures which coincided with these collections ranged from 16.00-17.55° C in 1952; in 1953, the surface temperature at St. 2 was as low as 13.80°. The reported temperature ranges in the literature are 13.94-17.50° (Perlmutter), 7.3-17.6° (Sette), and 4.0-app. 14.5° (Merriman and Sclar). Obviously the temperatures just given for L. I. S. are within the upper limits set by Sette.

The salinity during the spawning period ranged from 18.15 to 24.42‰, which is much lower than that reported for B. I. S. or other areas discussed above. No evidence has been found to indicate that these salinities were detrimental to embryonic development.

Egg diameters in 1952 ranged between 1.14–1.20 mm, averaged 1.16 mm, and had a standard deviation of .014; the oil globules ranged from 0.24–0.30 mm, averaged 0.28 mm, and had a standard deviation of .01 mm. The egg taken in 1953 was 1.29 mm, the oil globule 0.35 mm. These egg measurements are in agreement with Sette's figures but not with the lower limits given by Merriman and Sclar. On the whole, the globules were slightly smaller than those measured by Sette and by Merriman and Sclar. These eggs were compared with identified material at the U. S. Fish and Wildlife Service Laboratory at Woods Hole.

With so few eggs collected, it is not surprising that larvae were not taken. The mackerel is apparently one of the least abundant members of the spawning population in the Sound.

Poronotus triacanthus (Peck); Butterfish.

This species, a summer visitor to L. I. S., arrives in May and stays until October. While it is present in this area, it is frequently taken in small numbers by commercial fishermen.

Spawning. Our data indicate a shorter spawning season in L. I. S. than in B. I. S. Eggs were taken from L. I. S. from mid-June to mid-August only, whereas in B. I. S. they were taken from June through September (Merriman and Sclar). It appears that this species spawns more heavily offshore than in shallow enclosed areas.

Eggs. In 1952, 25 butterfish eggs (0.69–0.80 mm) were collected intermittently from June 19 until August 19. In 1953, only one egg (0.70 mm) was collected, on July 14. The numbers taken in these two years probably reveal either a variance in the abundance of the schools or a sampling deficiency. The temperature during the 1952 spawning season ranged from 16.40–22.30° C.

From our limited data (Table XIX), butterfish apparently preferred to spawn offshore at Sts. 2 and 5 rather than inshore at Sts. 1 and 8. Measurements in this table are insufficient to demonstrate a decrease in average egg diameter with progression of the spawning season, but the size range agrees well with that found in the literature.

Difficulties in separating butterfish eggs from those of squirrel hake (*U. chuss*) have been adequately reviewed by Merriman and Sclar. Since Merriman and Sclar's butterfish eggs could not be located, the eggs from L. I. S. which we considered to be those of the butterfish were compared with specimens taken by Sette in 1929

as well as with others taken aboard the ALBATROSS III in 1953 (stored at the U. S. Fish and Wildlife Service Laboratory at Woods Hole). Examination of butterfish and hake eggs together revealed that differences existed in both diameter and embryonic pigment. The dorsal embryonic pigmentation of the hake eggs, which are smaller than butterfish eggs, appeared in large paired blotches, much as illustrated by Perlmutter (1939), whereas that of the butterfish eggs was less pronounced and consisted of smaller irregular dots. No eggs of *U. chuss* were collected at any time in L. I. S. by us or by Perlmutter.

TABLE XIX. ABUNDANCE AND SIZE OF *P. triacanthus* EGGS FROM L. I. S. IN 1952–1953

Date	Eggs				Oil globule			
	No. meas.	Range	Average diam.	Standard dev.	No. meas.	Range	Average diam.	Standard dev.
1952								
June	6	0.74–0.78	0.75	.023	9	0.14–0.20	0.17	.011
July	18	0.70–0.80	0.74	.025	19	0.15–0.22	0.18	.010
Aug.	1	—	0.69	—	1	—	0.16	—
Total	25	0.69–0.80	0.75	.023	29	0.14–0.22	0.18	.014
1953								
July	1	—	0.70	—	2	—	0.15	—

St.	ABUNDANCE/M ³	
	1952	1953
1	0.01	0.00
2	0.21	0.00
5	0.15	0.04
8	0.04	0.00

In comparing butterfish and weakfish eggs at the lower size ranges, we found less pronounced differences than those between butterfish and hake eggs. Eggs of both butterfish and weakfish were collected simultaneously from the same localities in L. I. S., and measurements of our butterfish eggs (see Table XIX) agreed well with those given in the literature: a range of 0.69–0.80 mm for the eggs and an average diameter of 0.17–0.21 mm for the usually single oil globule. Although the size range of weakfish eggs in L. I. S. was 0.75–0.96 mm, for comparative purposes we will consider only those in the 0.75–0.80 mm range. Where there was more than one oil globule in eggs of this range, the globule measured 0.05–0.20 mm; however, when single globules occurred, the average size was 0.23–0.24 mm. In butterfish eggs, when more than one globule is present, the size range is 0.14–

0.22 mm. The dorsal embryonic pigmentation of the weakfish resembled that of the butterfish; in weakfish embryos the black pigment was dispersed to produce a spotty covering in the median dorsal head region whereas in butterfish it was lightly scattered along the dorsal edges of both head and body. Since fresh material, stripped from both species, should provide a clearer definition, an attempt was made at Woods Hole to strip and fertilize the eggs, but, as Kuntz and Radcliffe had discovered previously in 1915, completely ripe butterfish are unattainable from the traps near Quisset Harbor. As mentioned earlier, all attempts failed to raise eggs stripped from weakfish taken in L. I. S.

Larvae. None.

In conclusion, the butterfish spawning season in L. I. S. is considerably shorter and less prolific than that to the eastward in B. I. S., and butterfish eggs are difficult to separate from those of the weakfish.

Prionotus carolinus (Linnaeus); Common sea robin.

Prionotus evolans (Linnaeus);³ Striped sea robin.

Both of these species are commonly found in southern New England waters from April to October, and in the winter they move into deeper water (Bigelow and Schroeder).

Spawning. Perlmutter and others have affirmed that both species spawn in summer at this latitude, but Merriman and Sclar collected neither eggs nor larvae in B. I. S. During our survey, *P. carolinus* spawned from the first week in June until the end of August in both years; in 1952 *P. evolans* spawned from the first week of June to the first week of July, and in 1953 during June only.

Eggs. In both years, 22 *P. carolinus* eggs (1.00–1.25 mm) and 25 *P. evolans* eggs (1.05–1.25 mm) were taken in L. I. S.: in 1952, 13 *P. carolinus* eggs from June 4 to August 19, and in 1953 only nine between June 1 and August 5; in 1952, 24 *P. evolans* eggs from June 4 to July 8, and in 1953 only one on June 15.

³ Ginsburg (1950) investigated the populations of *P. evolans* along the Atlantic Coast of North America and found that there is no basis for separating *P. evolans* from *P. strigatus* (Cuv. & Val.).

The egg of this species has never been positively identified. Nichols and Breder (1926) maintained that it was demersal but Marshall (1946) doubted that this was so. Perlmutter (1939), on the basis of its resemblance to unfertilized eggs, made the tentative identification followed here. He reported that the eggs are similar in appearance and of approximately the same diameter as eggs of *P. carolinus* but that the oil globules are clustered at one pole rather than scattered throughout the yolk.

The distribution of these two demersal species is similar (Ginsburg, 1950). Although *P. evolans* may inhabit shallower water (Marshall, 1946), it appears likely that both species spawn at similar temperatures. When *P. carolinus* eggs were taken, the water temperature was 14.65–22.30° C, the salinity 25.42–27.12‰; for *P. evolans* eggs it was 13.80–18.42°, the salinity 19.93–26.17‰ (low salinity value at St. 128 due to outflow from the Housatonic River).

The eggs of both species were scattered throughout the eastern and central portions of the Sound almost exclusively; only one *P. evolans* egg was obtained at the western end (Fig. 1), at St. 128 off

TABLE XX. ABUNDANCE AND MEASUREMENTS OF *P. carolinus* AND *P. evolans* EGGS FROM THE REGULAR STATIONS IN L. I. S. IN 1952–1953

Station	Eggs/m ²			
	1952		1953	
	<i>carolinus</i>	<i>evolans</i>	<i>carolinus</i>	<i>evolans</i>
1	0.01	0.00	0.04	0.00
2	0.03	0.02	0.01	0.02
5	0.06	0.03	0.03	0.00
8	0.02	0.03	0.04	0.00

Date	<i>P. carolinus</i>				<i>P. evolans</i>			
	No. meas.	Range	Av. diam.	Stand. dev.	No. meas.	Range	Av. diam.	Stand. dev.
1952								
June	8	1.09–1.18	1.12	.027	22	1.05–1.25	1.13	.028
July	3	1.05–1.15	1.10	.050	1	—	1.10	—
Aug.	2	1.00–1.09	1.05	—	—	—	—	—
1953								
June	1	—	1.25	—	1	—	1.15	—
July	2	1.01–1.20	1.10	—	—	—	—	—
Aug.	6	1.01–1.14	1.06	.010	—	—	—	—

Stratford Point. At the regular stations (Table XX), a few more *P. carolinus* eggs were collected offshore in 1952; in 1953 a few more were collected inshore. In 1952 the eggs of *P. evolans* were fairly evenly distributed, except at St. 1.

The size of the eggs of these two species varied only slightly; our limited data suggest that *P. evolans* eggs are slightly larger than those of *P. carolinus* (Table XX). A decrease in diameter as the summer progressed was noted in the few eggs taken.

Larvae. One larva (2.2 mm long) taken at St. 2 on July 15 and another (3.0 mm) taken at St. 1 on August 19, 1952 were identified as *Prionotus* spp. Larvae and juveniles have been taken previously from this area (see Perlmutter as well as Warfel and Merriman).

Myoxocephalus spp.; Sculpins.

M. aeneus is a common resident in L. I. S. whereas *M. octodecimspinosus* is presumably present in L. I. S. in late winter only, since it has not been taken in the summer by previous investigators. In B. I. S. it migrates offshore in June where it stays until October. Morrow (1951) postulated that adults of *M. octodecimspinosus* enter L. I. S. in early spring, move westward, and, after reaching the area off Port Jefferson, turn and leave the Sound again, not to return until the following year. He demonstrated that this species spawns in winter off southern New England, and all investigators are of the opinion that it does not spawn west of B. I. S. However, to date no definite evidence has been produced to prove that the longhorn does not spawn in L. I. S.

Records of collections taken in L. I. S. by beach seine and the oyster dredge (unpublished) as well as reports by Greeley and by Warfel and Merriman show that juveniles of the brassy sculpin are more abundant in L. I. S. than those of the longhorn.

Spawning. *M. aeneus* spawns in winter at the same time as *M. octodecimspinosus* (Bigelow and Schroeder, 1953; Morrow, 1951).

Eggs. None.

Larvae. It is virtually impossible to separate the larvae of these two species until the fins are differentiated. Perlmutter collected 19 *M. aeneus* larvae (4.5–12.2 mm) from B. I. S. and off Montauk Pt. during the last two weeks in May, but, since he did not begin sampling until May 5, they may have been present in the area before that date. In collections from B. I. S., Merriman and Sclar obtained larvae of *M. aeneus* (8–10 mm) during the first two weeks of May and of *M. octodecimspinosus* (7–10 mm) from February to April. From their data it appears that *M. aeneus* hatches later than *M. octodecimspinosus*. In L. I. S. we took ten sculpin larvae (3.7–9.1 mm) in March and April only. The April larvae were well scattered throughout the eastern end of the Sound and were smaller than those taken in March (Table XXI); these compared favorably in size with the larvae of both species from B. I. S. Only one specimen (9.1 mm), taken on March 26, 1952, was identified as *M. aeneus* by anal fin ray count and by comparison with Perlmutter's illustrations; however, its body shape was essentially the same as Merriman and Sclar's preserved specimens of *M. octodecimspinosus*. For obvious reasons discussed, it is impos-

TABLE XXI. MEASUREMENTS OF *Myoxocephalus* spp. LARVAE FROM L. I. S. IN 1952–1954

Date	St.	Length
1952		
Mar. 5	7	7.9 mm
Mar. 26	5	9.1
1953		
April 8	316	3.7
	318	4.0
	318	5.0
	318	6.5
April 9	319	5.3
1954		
Mar. 30	411	8.4
Mar. 31	418 (IV)	6.0
April 12	426	5.3

sible to conclude whether these larvae are those of *M. aeneus* or *M. octodecimspinosus* or both.

The water temperature at the time these larvae were found varied from a minimum of 1.70° on March 5, 1952 to a maximum of 6.65° C on April 12, 1954 (St. 426).

Paralichthys oblongus (Mitchill); Four-spotted flounder.

This species is reported to be an early summer spawner (Perlmutter, 1939; Bigelow and Schroeder, 1953). Ripe *P. oblongus* were found in L. I. S. in July 1954 but the spawning season has not been ascertained.

Eggs? It is not known whether the eggs of *P. oblongus* were taken in L. I. S. in 1952–1953, since they are not distinguishable from eggs of *L. aquosa*.⁴

In July 1954, eggs of both species were artificially fertilized, and, although the eggs of *P. oblongus* survived slightly better than those of *L. aquosa*, neither developed beyond the 25-somite stage. Only these features of identification have been acquired thus far: (1) *P. oblongus* and *L. aquosa* were both in spawning condition in central L. I. S. in mid-July; (2) fertilized eggs of *P. oblongus*, which averaged 0.98 mm (average oil globule 0.15 mm), were slightly smaller than those of *L. aquosa*, which averaged 1.04 mm (average oil globule 0.17 mm); (3) embryonic pigment had appeared on *L. aquosa* at the 14-somite stage, whereas on *P. oblongus* it had not appeared at the 25-somite stage. With such meager information, the eggs of these

⁴ Efforts to locate the eggs of *P. oblongus* mentioned by Bigelow and Schroeder as artificially hatched by O. E. Sette were fruitless.

two species were not separated. However, they were considered as the eggs of *L. aquosa* because this species is more abundant in the area, because a greater number of definitely identified *L. aquosa* larvae were collected following the two peaks of egg abundance, and because, on the whole, the eggs in the plankton samples were the same size as the artificially fertilized eggs.

Larvae. Perlmutter collected larvae of this species in Gardiners Bay and off Montauk Point from late June through July. In our collections, one larva 3.0 mm long and in poor condition was taken on September 16, 1952 at St. 1, and this resembled Perlmutter's illustration of one 5.7 mm long. Our larva did not fit the illustrations of *Paralichthys* sp. in Hildebrand and Cable (1930) which they thought may have been *P. dentatus*. It is possible that the *P. oblongus* spawning season lasted longer than has been indicated by Perlmutter.

Lophossetta aquosa (Mitchill); Windowpane flounder.

This species is a common year-round resident in the shallow waters of southern New England. It is seldom eaten, but it does form a considerable part of the trash fishery in this area.

Spawning. According to Perlmutter, the windowpane is a summer spawner with maximum egg production in late May to mid-June. In 1952-1953, a split spawning season was observed in L. I. S.—from late April through July and from mid-September through late October or early November. This was similar to the split spawning season of the menhaden in 1952. If one ignores the nonspawning interval in August and early September, then the windowpane's spawning season was more prolonged than that of any other species taken in this survey.

Eggs. The eggs (0.90-1.38 mm) taken in the collections in 1952-1953 totaled 571 and ranked fourth in abundance (see Table I). The four groups were taken as follows: in 1952, 398 from April 16 to July 29, and 115 from September 9 to October 21; in 1953, 38 between April 15 and August 11, and 20 from October 14 to November 12. In general, during both years the eggs were more abundant during the earlier spawning season than during the later one (see Table I). This may indicate that a larger group of fish was spawning during the spring or that a similar spawning intensity in the fall was missed due to sampling errors.

In L. I. S. the surface temperatures that corresponded to the spawn-

ing seasons were: 7.0-22.2° and 21.45-15.2° C in 1952; 6.5-22.0° and 18.7-13.5° in 1953. Apparently temperature was not the primary cause for the split spawning season, for the average temperatures in the water column during the nonspawning periods (19.39° to 21.42°) were within the range of those recorded for the spawning season. According to Bigelow and Schroeder the eggs of this species were successfully hatched at Woods Hole at temperatures of 10.00-21.11°, but in L. I. S. eggs were taken in waters as low as 6.5°. Thus, the temperatures in the Sound during early spring spawning were much lower than those given by the aforementioned investigators, and it is possible that conditions for egg development are less favorable than at higher temperatures. In the spring, a period of six to eight weeks intervened between the appearance of the first eggs and the first larvae whereas in the fall the interval was only two weeks.

The salinity range during the spawning seasons of both years in L. I. S. was 18.15-30.00‰. Thus the maximum salinity in the Sound was considerably lower than that in certain other areas where they also spawn.

Perlmutter collected the eggs of this species by the hundreds between Peconic-Gardiners Bay and Montauk Point, to the south of Long Island, and in L. I. S. itself, and we found them in abundance from all portions of the Sound in 1952-1953. But, Merriman and Sclar record none from northeastern B. I. S. In our survey this was the only species whose eggs were collected at every station during the 100-cruise and at all but two of the stations in the 200-cruise (see Fig. 1). The data show that spawning (Table XXII) in both spring and fall in the central and western areas was greater than that in the eastern portion, where the quantity of eggs varied from station to station much more so than in the other portions, possibly due to stronger current movements in the eastern end. Apparently the windowpane seeks a somewhat sheltered spawning location.

Comparison shows that the average diameter of the eggs from the 100-cruise was the same as that from the 200-cruise—1.05 mm. At the regular stations, the average diameter in spring 1952 decreased from 1.19 to 1.05 mm, which is the same as the diameter obtained during the mentioned cruises. In spring 1953 there was a similar decrease. For the fall of both years, the data were insufficient to indicate a valid increase or decrease. The oil globule, usually only one per egg, ranged from 0.15-0.30 mm; when two or three globules were present in a single egg, the range was 0.05-0.16 mm.

asionally covered with scattered black chromatophores. The pigmentation on well developed embryos was faintly streaked on the dorsal side of both head and nape; dorsally and ventrally it appeared spotty along the trunk and tail; a short and narrow horizontal streak, similar to that in type A, was faintly visible along both caudal fin-folds.

Type C eggs: These were collected in the fall only, in September and October of 1952 and in October and November of 1953. They ranged in diameter from 1.0–1.2 mm (approximately the same size as the A eggs but smaller than the B eggs). At stations where both A and C eggs were collected simultaneously, the latter averaged slightly larger. The oil globules ranged from 0.06–0.20 mm; if single, the globule was never smaller than 0.15 mm. The embryonic pigmentation resembles that of B rather than A eggs.

In summary, type A eggs were taken in both spring and fall, whereas B eggs were taken only in the spring, C eggs only in the fall. A eggs were the same size but had different pigmentation than C eggs; the B eggs were larger than the A and C eggs and their pigmentation was similar to type C.

Due to prolonged absence in the field in 1953, we examined the samples in which these three types of eggs occurred after varying periods of preservation, and it is possible that changes in both size and pigmentation occurred in varying degrees with varying preservation. The 1952 spring samples were examined six months later, the 1952 100-cruise tows 15 to 20 months later, the 1952 summer and fall samples 12 months later, and the 1953 tows six to eight months later. In the spring of 1954 some windowpane eggs were examined within two days of preservation; comparison showed no differences between these and types A and B taken during the spring of 1952–1953. The diameter range of the 1954 eggs was 1.07–1.30 mm, and the embryonic pigmentation was both streaked and spotted.

Larvae. Unlike the eggs, the larvae of this species are easily identified. Seventeen larvae (1.8–7.6 mm) were collected during this survey from all portions of the Sound (Table XXIV). In 1952, nine (2.7–7.6 mm) were taken between June 4 and July 1 and most of them were obtained on the 100-cruise; only four were collected in the fall—on September 23 and October 8. In 1953, only four larvae were taken and they appeared later in both spring and fall collections; two were taken between July 7 and 28, and two more on

October 28. As in the case of the eggs, we note here a bimodality in the larvae collections; also we note that the fall larvae in both years were smaller than the spring larvae, and that both larvae and eggs appeared a month later in 1953 than in 1952. The numerical ratio of larvae to eggs was as follows: 1:44 in spring 1952, 1:38 in fall 1952, 1:19 in spring 1953, 1:9 in fall 1953. Bigelow and Schroeder estimated that embryonic development was completed in eight days in temperatures from 10.65–13.33° C, but temperatures in L. I. S. were above 15° during the time when larvae were collected. Earlier

TABLE XXIV. DISTRIBUTION, SIZE AND ABUNDANCE OF *L. aquosa* LARVAE FROM L. I. S. IN 1952–1953

Date	St.	No.	Length (mm)	Larvae/m ³
1952				
June 4	107	1	3.7	
5	113	1	3.4	
5	115	2	4.1	
			2.7	
5	118	2	4.4	
			4.3	
6	121	1	5.6	
11	130	1	7.6	June—0.03
July 1	2	1	2.8	July—0.01
Sept. 23	2	3	2.4	
			2.5	
			3.5	Sept.—0.006
Oct. 8	241	1	2.1	Oct.—0.005
1953				
July 7	8	1	2.4	
28	2	1	1.8	July—0.02
Oct. 28	2	2	3.5	
			2.4	Oct.—0.03

in the spring, before the larvae were collected, temperatures were below 10°, which may have prevented normal development of the eggs and which may explain, in part at least, the differences between the aforementioned spring and fall larvae-egg ratios.

Perlmutter obtained larvae in all areas sampled around Long Island, and his collections showed decreasing percentages from spring to fall: 62% in May, 37% in June, 1% in July and August, and none in the fall. Merriman and Sclar collected 4 larvae from B. I. S. in July. Juveniles, apparently quite common in the sublittoral zone, were obtained by Perlmutter, by Warfel and Merriman, and with the oyster dredge. Warfel and Merriman have inferred that there is a possibility that two races of windowpane occur in L. I. S.,

and Moore (1947), on the basis of vertebral counts, otoliths, and scale appearance, postulated that there were two races spawning at different times, one in May-June, the other in July-August. Moore has estimated that the growth of windowpanes in the first year is 2.95-3.54 inches (roughly 50-65 mm), that they attain this size by the following February or March, and that the 1+ age-group from L. I. S. is smaller and grows more slowly than the same age-group outside of the Sound. If L. I. S. windowpanes stem from two spawning stocks, then a true annual increment will be extremely difficult to judge.

Limanda ferruginea (Storer); Yellowtail flounder.

Spawning. This species spawns in southern New England in spring and summer. Perlmutter obtained larvae in B. I. S. and along the south shore of Long Island in May and June and Merriman and Sclar found them in B. I. S. from May to August.

Eggs. Only one egg (0.81 mm) was taken, that on April 8, 1953 at St. 316, outside Plum Island.

Larvae. Only one postlarva, 13.8 mm long and easily identified, was collected on April 9, 1952 at St. 1. This larva was not large enough to have originated in B. I. S., hence the yellowtail, which is not ordinarily considered a spawner in L. I. S., appears to spawn occasionally in this body of water. Considering the size of the specimen, it must have hatched in late March.

Pseudopleuronectes americanus (Walbaum); Blackback flounder.

The blackback, a nonmigratory species, is one of the most common flounders in L. I. S. It is of more value commercially in southern New England than any other demersal species. For example, the total catch in 1951 from Rhode Island and Connecticut was 3,029,200 pounds, valued at \$290,000. The total Connecticut catch alone has fluctuated little during the past 15 years, although the catch taken from L. I. S. by fishermen in New Haven and Fairfield Counties has fluctuated greatly. Perlmutter has stated that the blackback population here is made up of many localized stocks that inhabit shallow areas and that the young in any one area are probably the product of fish spawning in that area.

Spawning. In southern New England waters the blackback spawns from December to May. However, in L. I. S. we took no eggs at any time and obtained no larvae until late March. As dis-

cussed below, it is estimated that the spawning season in L. I. S. during this survey extended from February or early March until the last week of May.

Eggs. None.

Larvae. In 1952-1954, 63 larvae (2.8-8.5 mm) were taken and the majority were still upright: in 1952, 17 between April 9 and June 6; in 1953, 14 between March 23 and May 25; and in 1954, 32, the first of these appearing in our samples on March 30. Blackback larvae were fourth in relative abundance of all species, and the peak of abundance occurred in April, excepting 1952, when the peak was in May.

When larvae were present in our collections the surface temperature

TABLE XXV. REGIONAL ABUNDANCE OF *P. americanus* LARVAE FROM L. I. S. FROM MARCH 1952-APRIL 1954

EASTERN END		CENTRAL PORTION	
St.	Larvae/m ³	St.	Larvae/m ³
119	0.10	107	0.07
313	0.12	302	0.09
314	0.26	303	0.09
318	0.20	405	0.11
319	0.17	418 (IV)	0.03
			1952 1953
		1	0.05 0.05
		2	0.04 0.02
		5	0.06 0.00
		8	0.04 0.00

ranged from 5.65-13.30° C, although it is known that they occur in water as warm as 22.17° (Perlmutter, 1939). The known salinity range when blackbacks spawn is great—from over 30.0‰ in the Gulf of Maine to 11.14‰ in Woods Hole, Mass. (Bigelow and Schroeder). The spring salinity range in L. I. S. is well within these limits.

Our data show that blackback larvae were widely scattered throughout the Sound and displayed no center of abundance (Fig. 1 and Table XXV). Preliminary examination of material collected in 1954 indicates that depth may be a limiting factor.

Bigelow and Schroeder have maintained that larvae in the Gulf of Maine are 3.0-3.5 mm at hatching. In L. I. S. we found larvae 3.0 mm long and a minimum hatching length of 2.8 mm. Perlmutter has maintained that eggs are initially laid in December in southern New England, and Bigelow and Schroeder have reported that em-

bryonic development takes place in 13-15 days at temperatures of 2.78-3.33° and that larval growth to 5 mm takes place in 12-14 days at temperatures of 3.89°. Thus, larvae should have been present in L. I. S. in January, but, as noted, they were not taken until late March. If the rate of development is as Bigelow and Schroeder have stated it, then the 5.7 mm specimen taken in 1952 on June 6 at St. 119 should have hatched during the first week of June; the two larvae (av. 5.9 mm) taken in 1953 on May 25 at St. 1 should have hatched during the third week of May; and in 1954 the metamorphosing larvae (7.5 and 8.5 mm) taken on May 10 at St. 524 (not included in Table XXV) should have hatched in late April. The 5.7 mm specimens collected in 1952 on June 6 indicate that spawning may have continued until the end of May while in 1953 the last specimens which were collected on May 25 indicate that spawning may have ended in mid-May. It is quite possible that temperature variation in winter and spring was at least one of the factors that delayed the appearance of larvae in 1952 and prolonged their appearance later that same year. The colder water temperature during the spring of 1952 as compared with that of 1953 and 1954 may have delayed spawning and hatching and decreased the growth rate, which would have resulted in a delayed appearance of the larvae plus a longer pelagic life. After metamorphosis the larvae became demersal and no longer appeared in our samples.

Postlarvae have been taken from many localities within the Sound by: Perlmutter; Greeley; Warfel and Merriman; Merriman (1947); and the oyster dredge. Juveniles, also taken in abundance, grow roughly 20 mm between June and September.

Sphaeroides maculatus (Bloch and Schneider); Puffer.

A summer visitor to L. I. S., this species arrives in mid-May and remains until mid-October.

Spawning. In this general latitude it lasts from late May until August with the peak in July (Welsh and Breder, 1922).

Eggs. None.

Larvae. Only one larva (5 mm) was taken, on August 19, 1952 at St. 5. This indicates that spawning continued well into August. Its brilliant coloration over the anterior section of the body (faded in preservative) and its shape permitted unmistakable identification. This larva was taken from an area of greater depth than would be

normally expected. Juveniles have been taken frequently by previous investigators on shallow sandy beaches and in estuaries, and it is quite likely that we would have taken more had our collections included such habitats. Probably our specimen had been carried out into deeper water. The growth increment during the summer has been estimated as *circa* 41 mm.

"Unknown 1."

During the 200-cruise, four unidentified eggs of similar appearance were collected from scattered localities (see Table XXVI). The embryonic pigmentation in the egg taken X-9-52 resembled that of a developing scup, but its time of appearance, late in the year, and its small size suggest that it might be either *Leiostomus xanthurus* or

TABLE XXVI. DISTRIBUTION AND SIZE OF "UNKNOWN 1" EGGS FROM L. I. S. IN 1952-1953

Date	St.	Egg diam.	Globule diam.
1952			
Sept. 29	208	0.72	0.20
Oct. 1	222	0.74	0.17, 0.15, 0.16
2	225	0.76	0.24
9	243	0.89	0.14, 0.14
		Av. 0.78	Av. 0.17

Cynoscion regalis, more likely the latter. Adults of *L. xanthurus* have been reported in L. I. S. from May to November or December (Nichols and Breder, 1926) and juveniles have been taken occasionally in beach seine hauls, but there is no available information concerning their spawning in the Sound. Hildebrand and Cable (1930) have maintained that the spot spawns in autumn and that the unidentified eggs must be small because the recently hatched prolarva is small (1.5 mm). This is not necessarily so, since the egg of *L. aquosa* is little more than 1.0 mm while the recently hatched larva is 1.8 mm (see p. 292). Regarding the possibility of their being *C. regalis*, Welsh and Breder (1926) have pointed out that their spawning season continued until September, Perlmutter (1939) has mentioned the possibility of local races spawning at different times, and we have found that the diameters of both egg and oil globules conform to the same characters observed in weakfish eggs.

DISCUSSION

The data in this paper are based on 272 oblique plankton tows taken in the Sound during this survey; most of the hauls were made at the regular stations in the central portion. In addition, a few experimental observations were carried out, and these are discussed under MATERIALS and METHODS and later in this section. Although our data by no means supply the answers to many of the questions raised in an investigation of this nature, they do serve as a sound basis for further study. Analysis is complicated by the variations which result from changes in environmental conditions, from sampling procedures, and from movements of the spawning populations. Comparison of plankton hauls taken simultaneously have indicated the significance of such variations. Winsor and Walford (1936) felt that an increase in the "total catch" by using a larger net did not necessarily provide a more accurate estimate of the population, since such an estimate is limited by the volume of water sampled. Winsor and Clarke (1940) maintained that the catch with a small 12.7 cm net gave as reliable an indication of the plankton types as any of the larger nets (75 and 30 cm) and that the variability between oblique tows was less than that between vertical tows. Silliman (1946), in an analysis of duplicate laboratory samples of 24 paired plankton hauls for eggs of the pilchard, demonstrated that the variability was due to variation in egg concentration in the water and that a single count may be considered significantly different from another if it is less than half or more than double the other.

On some occasions, two nets of different size, 12.5 and 30 cm, both with No. 2 mesh, were towed simultaneously. Although the larger net strained more water and took a larger number of organisms, little difference in the number of organisms was noted after prorating the volume of water sampled by each net. However, it appears that the larger net collected larger larvae. Generally the 30 cm net has not been used extensively since no valid way has been found to measure the volume of water filtered. Also, two 12.5 cm nets, one with No. 2 and the other with No. 10 mesh, were towed successively at the same station. No significant differences were noted in the number of eggs and larvae or in the size of the larvae, but the No. 2 mesh collected a significantly greater variety of the less abundant summer species, possibly because it filtered more water. In the

1952-1953 samples, the larvae that were present at the time of sampling are probably represented with a fair degree of accuracy qualitatively but not quantitatively, particularly if some of the larvae could escape the net, especially in daylight. On the other hand, the eggs in the samples probably give a valid representation both qualitatively and quantitatively. At any rate, regional and seasonal differences based on these tows are probably fairly representative of the sampled areas. Of course, further observation is desirable.

The pelagic eggs and larvae of 24 species of fish were collected in the course of this study. Of these, 12 species were represented by both eggs and larvae, nine by larvae only, and three by eggs only. Of the nine species represented by larvae *C. harengus*, *M. m. notata*, *A. americanus*, *Myoxocephalus* spp., *P. americanus*, and *S. maculatus* hatched from demersal eggs which were not collected in our tows; *A. rostrata* spawns in the mid-Atlantic, and *S. peckianus* carries its eggs in a pouch. The eggs of *P. oblongus* were not identified, and, if collected, they were included with the eggs of *L. aquosa*. Regarding the three species represented by eggs alone (*P. triacanthus*, *S. scombrus*, and "Unknown No. 1"), the eggs of only *P. triacanthus* were taken in fair quantity; the absence of the larvae remains unexplained.

During the past 15 years two surveys (Perlmutter, 1939; Merriman and Sclar, 1952) in addition to ours have been made in southern New England waters and the eggs and larvae of 45 or 46 species have been identified. Because of the different gear used in each survey, only qualitative comparison is possible (Table XXVII). Perlmutter, whose collections extended over a much wider area than those of the other two surveys and covered a much shorter period of time (May-October), took 23 species which were not taken by Merriman and Sclar and 18 which were not taken by us. In collections which cover such a wide range of habitats, it is inevitable that one survey will include eggs and larvae of some species which are not present in others. In view of the fact that Perlmutter's survey included the south shore of Long Island and southern B. I. S., he collected some species whose range seldom extends into L. I. S. Among these are *Hippocampus hudsonius*, *Vomer setapinnis*, *Bairdiella chrysur*, *Achirus fasciatus*, and *Chilomycterus schoepfii*.

While the B. I. S. area has yielded the eggs and larvae of a number of species that came from the eastward and northeastward of this region, none except the larvae of the pollack have been taken in

TABLE XXVII. LIST OF SPECIES TAKEN IN EACH SURVEY OF PELAGIC FISH EGGS AND LARVAE IN SOUTHERN NEW ENGLAND WATERS

Species	Perlmutter, 1938		
	L. I. S., southern B. I. S. and south of Long Island	Merriman and Sclar 1943-1946 northeastern B. I. S.	Wheatland 1952-1953 L. I. S.
<i>Clupea harengus</i>	X	X	X
<i>Brevoortia tyrannus</i>	X	X	X
<i>Anchoa m. mitchilli</i>	X	-	X
<i>Anguilla rostrata</i>	X	-	X
<i>Conger oceanicus</i>	X	-	-
<i>Merluccius bilinearis</i>	X	X	-
<i>Gadus morrhua</i>	X	X	-
<i>Melanogrammus aeglefinus</i>	X	-	-
<i>Pollachius virens</i>	X	-	-
<i>Urophycis chuss</i>	X	X	-
<i>Urophycis regius</i> and/or <i>tenuis</i>	-	X	-
<i>Enchelyopus cimbrius</i>	X	-	X
<i>Syngnathus peckianus</i>	X	X	X
<i>Hippocampus hudsonius</i>	X	X	-
<i>Menidia m. notata</i>	X	-	X
<i>Centropristes striatus</i>	X	-	-
<i>Pomatomus saltatrix</i>	X	-	-
<i>Vomer setapinnis</i>	X	-	-
<i>Bairdiella chrysura</i>	X	-	-
<i>Cynoscion regalis</i>	X	X	X
<i>Menticirrhus saxatilis</i>	X	-	X
<i>Stenotomus chrysops</i>	X	X	X
<i>Ulua subbifurcata</i>	X	-	-
<i>Gobiosoma bosci</i>	X	-	-
<i>Gobiosoma ginsburgi</i>	X	-	-
<i>Tautoglabrus adspersus</i>	X	X	X
<i>Tautoga onitis</i>	X	X	X
<i>Ammodytes americanus</i>	-	-	X
<i>Scomber scombrus</i>	X	X	X
<i>Poronotus triacanthus</i>	X	X	X
<i>Prionotus carolinus</i>	X	-	X
<i>Prionotus evolans</i>	X	-	X
<i>Cryptacanthodes maculatus</i>	-	X	-
<i>Cyclopterus lumpus</i>	X	X	-
<i>Myoxocephalus aeneus</i>	X	X	X
<i>Myoxocephalus octodecimspinosus</i>	-	X	?
<i>Paralichthys oblongus</i>	X	X	X
<i>Paralichthys dentatus</i>	-	X	-
<i>Lophopsetta aquosa</i>	X	X	X
<i>Limanda ferruginea</i>	X	X	X
<i>Pseudopleuronectes americanus</i>	X	-	X
<i>Achirus fasciatus</i>	X	-	-
<i>Sphaeroides maculatus</i>	X	-	X
<i>Chilomycterus schoepfi</i>	X	-	-
<i>Lophius americanus</i>	X	X	-
Total	40	22	23

L. I. S. These species are *Gadus morrhua*, *Melanogrammus aeglefinus*, *Pollachius virens*, *Merluccius bilinearis*, *Urophycis chuss*, *Ulua subbifurcata*, *Cryptacanthodes maculatus*, and *Lophius americanus*. Some species, namely *Centropristes striatus*, *Pomatomus saltatrix*, and *Paralichthys dentatus*, probably spawn offshore, hence their eggs and larvae have been taken more frequently in B. I. S. than in L. I. S. The larvae and juveniles of many inshore species that were taken by Perlmutter in shallow protected areas were not taken by Merriman and Sclar and by us in more open waters. Some inshore species, such as *B. tyrannus*, *A. m. mitchilli*, *M. m. notata*, *M. saxatilis*, *P. americanus* and *S. maculatus*, which were taken from L. I. S. and the south shore of Long Island apparently do not congregate in northeastern B. I. S. during the spawning season.

There is no satisfactory explanation to account for the scarcity in B. I. S. of eggs and larvae of such species as *Prionotus* spp., *P. oblongus*, *E. cimbrius* and *A. americanus*, all of which were taken in L. I. S. *Prionotus* spp. and *P. oblongus* are supposedly common along the entire New England coast during the spawning season in the summer, and *A. americanus* spawns in winter and early spring. Perlmutter could not have taken *A. americanus*, since his collections were made from May to October, but it seems reasonable to expect that *A. americanus*, as well as *E. cimbrius*, should have been taken in northern B. I. S., since the larvae of these two species have been collected in open waters in the Gulf of Maine and to the east and south of Block Island. Either environmental factors not yet known or sampling errors may account for their absence in B. I. S.

It is common knowledge that many species move between deeper and shallower waters during certain seasons of the year. In the summer, *B. tyrannus*, *C. regalis*, *S. chrysops*, *M. saxatilis*, *P. triacanthus*, *P. carolinus* and *P. evolans* move into the Sound and probably return to deeper waters outside in the fall. In winter, *C. harengus*, *E. cimbrius* and occasionally *L. ferruginea* move into the Sound and subsequently move outside in late winter and spring. Of the L. I. S. residents, *A. m. mitchilli*, *S. peckianus*, *M. m. notata*, *T. adspersus*, *T. onitis*, *P. carolinus*, *P. evolans*, *L. aquosa*, and *P. oblongus* move into deeper water in late fall and remain there until April. However, *P. americanus* and *Myoxocephalus* spp. remain in shallower areas during the winter.

If we consider observations from all sources (e. g., Perlmutter,

Greeley, Warfel and Merriman, Merriman, oyster dredge samples, etc.) we find that in L. I. S. as a whole there is a greater variety of species represented by the juveniles than by the eggs and larvae. On the other hand, if we exclude those juveniles that are spawned in fresh water or in waters close to the littoral zone, then we find a larger number of species represented by eggs and larvae than by juveniles. Frequently we find some species represented by the eggs and larvae which are not represented by the juveniles, and vice versa.

Of the 43 species represented by juveniles, 25 were not represented by eggs and larvae in our survey in 1952-53. Some of those not collected by us, such as *Pomolobus pseudoharengus*, *Osmerus mordax*, *Morone americana*, spawn in fresh water. Others, such as *Fundulus majalis*, *Fundulus heteroclitus*, *Fundulus luciae*, *Menidia beryllina cerea*, *Caranx hippos*, *Microgadus tomcod*, *Pholis gunnellus*, either lay demersal eggs or spawn close to shore in weedy habitats. Still others appear not to spawn within the Sound, namely *Conger oceanicus*, *Urophycis chuss*, *Urophycis regius*, *Urophycis tenuis*, *Merluccius bilinearis*, *Bairdiella chrysura*, and *Pomatomus saltatrix*. *Synodus foetens*, a southern form and spring spawner (Breder, 1944), appears in the Sound during summer.

A total of 18 species which have been represented by juveniles in previous collections from L. I. S. were also represented by eggs and larvae in our samples from 1952-53. This group includes the majority of the most abundant species, such as *A. m. mitchilli*, *M. m. notata*, *T. adspersus*, *P. americanus* and *L. aquosa*. But there were three species represented in our samples by eggs and larvae which have never been recorded before as juveniles: *S. scombrus*, *L. ferruginea*, and *P. oblongus*.⁵

It is evident from the little we know about the life histories of all species that inhabit these waters that there is a constantly shifting population of juveniles; many which are hatched outside enter the Sound during their first year, and almost as many which are hatched in the Sound move outside. In the over-all picture of L. I. S. the importance of the sublittoral noncommercial groups of fishes must be emphasized as well as that of the commercially important species.

During the two years of our survey, the average number of eggs taken throughout the entire Sound decreased from 7.42 in 1952 to

⁵ On October 10, 1955 one specimen of this species was taken at St. 1.

2.30/m³ in 1953, and the average number of larvae decreased from 0.73 to 0.36/m³. At the regular stations, a striking decrease in both numbers and variety of eggs and larvae occurred in 1953 (Table XXVIII). This appears to be due in large measure to anchovy spawning at the inshore stations, where larger quantities of eggs were taken in 1952 as compared with 1953, and furthermore, in the latter year the eggs of all species appeared more evenly distributed. The greater variety of eggs in 1952 may have been due to the fact that a greater volume of water was sampled that year.

When a complete annual cycle of spawning activity in L. I. S. is considered, its seasonal nature is apparent (Fig. 2). Following a period of low spawning activity in late fall and winter, a peak in both

TABLE XXVIII. REGIONAL ABUNDANCE OF EGGS AND LARVAE OF ALL SPECIES IN L. I. S. IN 1952-1953

Station	Eggs/m ³		Larvae/m ³	
	1952	1953	1952	1953
1	36.0	1.3	0.82	0.24
2	7.7	2.9	1.7	0.43
5	4.4	0.69	1.1	0.42
8	24.0	4.8	0.79	0.29
100a*	8.9	—	0.07	—
b*	1.9	—	0.07	—
200a*	0.74	—	0.04	—
b*	0.61	—	1.00	—
300a	—	1.1	—	0.16

* a indicates eastern end, b western end.

variety and number of eggs occurred in late spring and summer when conditions were undoubtedly optimal for the greater percentage of the spawners. The low in abundance of eggs occurred from November through February and of larvae from April through June; the maximum of eggs was recorded in June and July and of larvae in September and October. The peak in larvae abundance during winter clearly reflects the spawning of *A. americanus*.⁶ No doubt some of the spring spawners produced eggs before conditions were suitable for successful development of the larvae.

The data for the long cruises more or less reflect the same seasonal nature of spawning. On the 100-cruise, a greater number and variety

⁶ At the southern end of its range this genus spawns in winter, but farther north it spawns later in the spring, and in Iceland and Greenland it spawns as late as June (Einarsson, 1951).

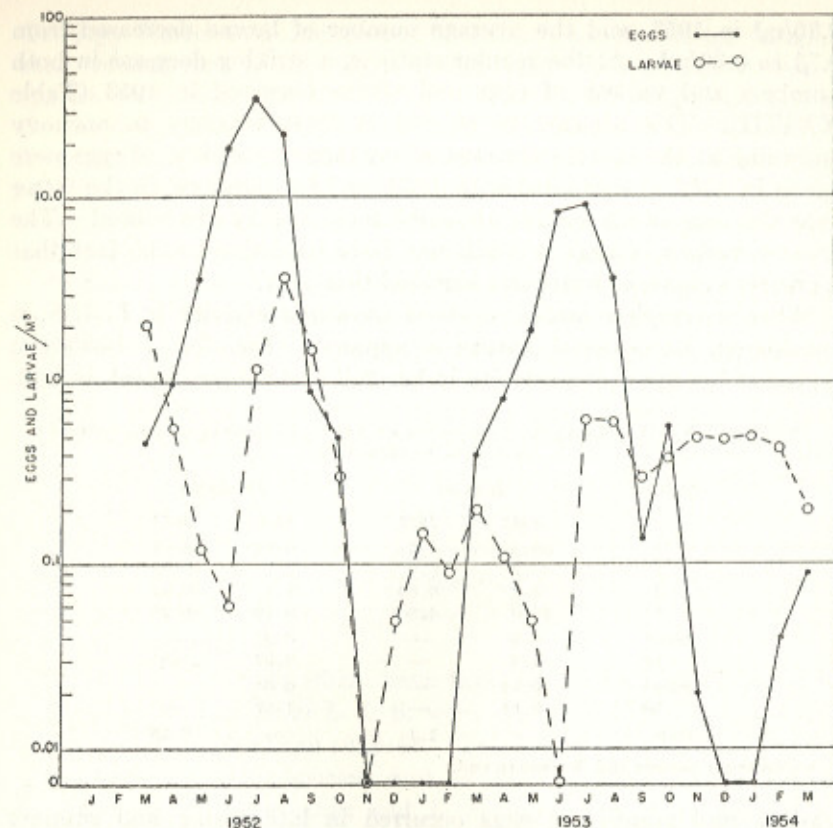

Figure 2. Total number of eggs and larvae per cubic meter from L. I. S. taken each month during 1952-1954.

of eggs were obtained, whereas on the 200-cruise, when the actual spawning of many species had ceased, we found better representation of larvae. The 300-cruise showed the decline of *A. americanus* larvae, the continued spawning of *E. cimbrius*, and the initial appearance of *P. americanus* larvae.

Regional variations in abundance of eggs and larvae were also apparent. At the regular stations, those offshore yielded eggs and larvae of the greatest variety of species, the major ones being *A. m. mitchilli*, *B. tyrannus*, *E. cimbrius*, *A. americanus*, and *L. aquosa*. Eggs and larvae of *A. m. mitchilli*, *E. cimbrius*, *T. adspersus*, *T. onitis*, *A. americanus*, and *P. americanus* occurred in greater abun-

dance at the inshore stations. A few larvae, more usually collected near shore, were taken at St. 5: *M. m. notata*, *S. peckianus*, *M. saxatilis*, and *S. maculatus*. Eggs and larvae of more species were collected at the eastern than at the western end of the Sound, but more eggs were actually taken at the western end; these facts were more evident from data of the 100-cruise than from those of the 200-cruise.

Though desirable, a discussion of the larval survival of each species on the basis of the information at hand is not possible, since data on size composition of the larval population, net selectivity, escapement, differences in daily growth rates, etc. (Ahlstrom, 1954) would be necessary to arrive at a reasonable figure. Ahlstrom, in work on *S. caerulea*, arrived at a minimum survival figure of 1 in 1,000 for larvae up to 21 mm. In our survey, the number of larvae captured in 1952 was 10% of the total number of eggs, and in 1953 it was 15%, including larvae that were hatched from demersal eggs which were not collected. Obviously this rough estimate of 10 and 15% is unduly high and is not a valid indication of larval survival. Therefore, it seems feasible to limit our considerations to the physical and biological factors that influence the location and abundance of eggs and larvae.

The primary physical factors that may cause fluctuations in egg abundance are salinity and temperature, tidal currents and nontidal drifts, wind force and direction, and precipitation. Since each species has definite salinity and temperature requirements for successful egg development, it is quite reasonable to assume that oceanic fish were prevented from spawning in the Sound where salinity over a year ranged between 24.00 and 30.00‰ and dropped as low as 18.15‰ near river mouths during spring. In spring 1953, a lowered salinity due to abnormal precipitation may have been one of the factors that delayed the summer spawning season of a number of species (see also Merriman and Selar for a discussion of the possible effect of abnormal salinity on survival of butterfish, weakfish and cunner eggs in B. I. S.).

In the Sound the annual temperature range is great, from 0.85 to 23.50° C. While such extensive variations may discourage some species from spawning here, it does provide a varied environment which is suitable for a greater number of species than would be expected otherwise. A delayed spawning of *L. aquosa* and the continued appearance of *A. m. mitchilli* and *B. tyrannus* larvae in autumn 1953 may have been due to a consistently higher temperature at that time.

According to Walford (1938) and Carruthers and co-workers (1951), surface drift and wind variations may have a decided effect on larval survival. In the Sound, surface drift may have been responsible for the presence of larvae of sublittoral spawners at offshore St. 5, but it was concluded that the surface drift of inshore waters was not influential in causing the varied distribution of the eggs of cunner, tautog, and anchovy.

The major biological factors which influence egg abundance include the habits of each species, the food available for both larvae and adults, and predation. While much is known about the life history of some species that frequent the Sound, relatively little is known about others. Such information is extremely valuable in a study of this nature, and much remains to be done in obtaining the basic information. However, even if fairly complete biological data become available, variations in biological as well as physical factors which influence egg production will complicate analysis. In L. I. S. the number and distribution of eggs of schooling species fluctuated somewhat more than did those of the semischooling or solitary fish, probably due in large measure to the uniform behavior patterns and requirements of these schooling fish. In 1952 the menhaden appeared in early summer when the phytoplankton was abundant whereas at the same time in 1953 it did not turn up when the phytoplankton was less plentiful. Actually, less species spawn during the phytoplankton bloom than at other times. It appears that the larvae do not fully utilize the plentiful supply of zooplankton that is available in the Sound, and a study of feeding analyses would be highly desirable.

From our data we estimate that the average number of eggs per year for all species is 2-7 per cubic meter. When we consider other studies in this survey, L. I. S. has a high potential as a spawning area and nursery ground for the young. Unfortunately, no organized quantitative studies of juveniles have been made in this area, hence the importance of this element of the population in the over-all picture cannot be evaluated. But previous observations have indicated that the adult fishery in the Sound is considerably smaller than that of B. I. S. Although data indicate a rich planktonic and benthic fauna it appears that the fish population in L. I. S. does not completely utilize the available food supply.

ADDENDUM ON EGG DIAMETER DECREASE

The eggs of some species which have long spawning seasons, such as *B. tyrannus*, *E. cimbrius*, and *T. adspersus*, showed a decrease in egg diameter as the season progressed. Whether this decrease was natural or artificial we do not know, but five possible explanations seem pertinent.

1. The decrease in diameter may be correlated with the length of time the eggs were preserved. Gorbunova (1952) found that eggs of the gadid *Theragra chalcogramma*, taken in the Japan Sea, shrank noticeably when preserved for 5 to 10 months in 2% formalin. Measurements of eggs of some species taken in L. I. S. indicate that a decrease occurred in both nature and preservative. Of eggs taken during spring 1952 at the same time and location, some were measured after 6 to 8 months while the others were measured after 24 to 26 months in the identical preservative, giving an interval of 18 months between measurements; the latter eggs were smaller than the former, thus indicating an artificial decrease due to preservation beyond a progressive natural decrease that had also been observed. A natural decrease in size during the spawning season was demonstrated in the eggs of *A. m. mitchilli* and of other species; those taken on the 100-cruise in June were larger than those obtained during the summer at the regular stations; further confirmation is found in the fact that the larger eggs, taken earlier, were measured 12 months later than the others.

While preservation may bring about some decrease in egg size, our data indicate that there is quite certainly a decrease in nature due to one or more factors. More complete observations are being performed to determine, if possible, the effect of long preservation on the egg size of each species. Further study is also needed to ascertain the extent of changes in egg size in nature.

2. The decrease in size may be correlated with the shape and structure of the eggs. Many eggs, such as those of *S. caerulea* (Ahlgren, 1943), *Hippoglossoides platessoides* (Bigelow and Schroeder, 1953), *Sardinops ocellata* (Davies, 1954), and *T. chalcogramma* (Gorbunova, 1952), swell and develop a large perivitelline space when they come in contact with water. Similar behavior is found in the egg of *B. tyrannus*, which showed marked diameter differences during spring and fall in L. I. S. While eggs with a large perivitelline space

may be more susceptible to changes in either sea water or preservative, it is probably not the only factor, since eggs without such a space also show a tendency to decrease.

3. The size may be affected by changes in environmental factors such as salinity, temperature, or density of the water mass. Delsman (1931), in observations on the size of *Cybiium guttatum* eggs, demonstrated that an increase in salinity caused a decrease in diameter, and he maintained that this same phenomenon had been observed in the Baltic and North Sea. Hildebrand and Cable (1934) believed that the apparent discrepancy in the size of *C. regalis* eggs measured by Welsh and Breder (1923) may have been due to differences in salinity. Other investigators have maintained that temperature was the more important factor. Fish (1928) demonstrated that cod eggs fertilized in cold water were larger than those fertilized in warm water, and Sette (1943), on the basis of Fish's observations, maintained that temperature alone could be responsible for differences in the size of fish eggs of the same species. Sette, in his own work on *S. scombrus* eggs, reported a tendency of the eggs to decrease in size as the spawning season advanced, a tendency which he felt might be applicable to the eggs of all species taken during his investigation. Ehrenbaum (1923) noted the same condition in the eggs of the European mackerel. Some years later, Fridriksson and Timmermann (1951), working with herring, concluded that the eggs of the Icelandic race were larger than those of European or Norwegian races, but they make no mention of comparative sizes of the adults relative to the locality, a factor which may be important. It seems reasonable to postulate that lower temperatures around Iceland may have been responsible for the larger eggs. Farran (1938) discovered that the ovary of spawning Irish herring had fewer but larger eggs in the spring than in the fall. This phenomenon is primarily genetic in origin, but he maintained that it may have resulted from the cooler spring water temperatures.

Rass (1941) stated that the size of eggs of aquatic animals was inversely proportional to the breeding temperature, but Marshall (1953) maintained that this was an oversimplification. According to Marshall's viewpoint, the larger eggs of species that inhabit oceanic bathypelagic and polar inshore waters hatch into relatively larger larvae; these in turn have an advantage over smaller larvae in that they require less food for their size and have greater swimming

powers, thus enabling them to obtain planktonic food more successfully in areas where it is less abundant.

In L. I. S., menhaden eggs in the spring were larger than those in the fall, and the spawning period of most species whose eggs decreased in size occurred when water temperatures were steadily increasing.⁷

4. The size of the egg may be correlated with the size of the parent fish. Toots (1951) demonstrated that the larger whitefish (*Coregonus*) from seven northern Swedish lakes usually have larger eggs on the average than the smaller fish. But he did not state whether the smaller fish as a group spawned earlier or later than the larger fish in the same population, nor did he indicate whether the populations of different lengths spawned simultaneously in the different lakes. Since the number of eggs per gram weight was greater in fish of smaller length, he reasoned that the eggs must therefore be smaller. Both Clark (1934) and Kisselwitch (1923) found that the total number of eggs was greater in larger specimens of the California sardine and the Caspian herring and that the number of eggs increased with the square of the length. But they draw no conclusions as to whether or not the size of the eggs changed with length of the fish. Clark observed that the larger sardines spawned longer and later than the smaller ones, but she did not note the size of the eggs throughout the season. No information on this subject is available for L. I. S., since the parents were not collected.

5. The size of the egg is affected by the metabolism of the parent. In the process of producing the genital products and of spawning, a fish is probably sufficiently affected physiologically so that eggs of equal size are not produced over the whole period. Clark (1934), working with *S. caerulea* which spawns as much as three times during its long spawning period (February to August), found that a new group of the eggs was ripening as the ripe ova were being spawned. She stated ". . . the decrease throughout the season in ratios of the different groups of eggs [of small to large eggs in the ovary] did not result from changes in the sizes of fish making up the catch but was brought about by the spawning out of successive batches of eggs . . . presumably as the spawning season advanced, succeeding groups of eggs failed to undergo a corresponding growth and spawning finally ceased after the largest group of eggs had been spawned out."

⁷ Of the four fall spawners, only the menhaden eggs showed a change in size—a slight increase between August and October.

This then would leave us in doubt as to whether smaller eggs resulted with each successive spawning.

REFERENCES

- AHLSTROM, E. H.
1943. Studies on the Pacific pilchard or sardine (*Sardinops caerulea*). 4. Influence of temperature on the rate of development of pilchard eggs in nature. Spec. Sci. Rep. Fish Wildl. Serv., No. 23: 1-26.
1954. Distribution and abundance of egg and larval populations of the Pacific sardine. Fish. Bull., Fish Wildl. Serv., 56, No. 93: 83-140.
- ANONYMOUS
1948. New style oyster dredger the "Quinnipiac" launched at Quincy, Mass. Fish. Gaz., 65 (2): 40, 42, 72.
- BAIRD, S. F.
1855. Report on the fishes observed on the coasts of New Jersey and Long Island during the summer of 1854. 9th Ann. Rep. U. S. nat. Mus. (1854): 317-337.
- BATTLE, HELEN I.
1929. Effects of extreme temperatures and salinities on the development of *Enchelyopus cimbrius* (L.). Contr. Canad. Biol., 5 (6): 109-192.
1930. Spawning periodicity and embryonic death rate of *Enchelyopus cimbrius* (L.) in Passamaquoddy Bay. Contr. Canad. Biol. (1929), 5 (11): 363-380.
- BEAN, T. H.
1903. Catalogue of the fishes of New York. Bull. N. Y. St. Mus., 60, Zool. 9. 784 pp.
- BERG, L. S.
1940. Classification of fishes, both recent and fossil. Zool. Inst. Acad. Sci. U. R. S. S., 5 (2): 346-517 (English). Moscow and Leningrad.
- BIGELOW, H. B. AND W. C. SCHROEDER
1953. Fishes of the Gulf of Maine. 1st revision. Fish. Bull. Fish Wildl. Serv., 53, No. 74: 1-577.
- BIGELOW, H. B. AND W. W. WELSH
1925. Fishes of the Gulf of Maine. Bull. U. S. Bur. Fish. (1924), 40 (1): 1-567.
- BREder, C. M. JR.
1929. Field book of marine fishes of the Atlantic coast from Labrador to Texas. G. P. Putnam's Sons, New York. 332 pp.
1944. The metamorphosis of *Synodus foetens* (Linnaeus). Zoologica, N. Y., 29 (1): 13-16.
- CARRUTHERS, J. N., A. L. LAWFOED AND V. F. C. VELEY
1951. Fishery Hydrography: Brood-strength fluctuations in various North Sea fish, with suggested methods of prediction. Kieler Meeresforsch., 8 (1): 5-15.
- CARRUTHERS, J. N., A. L. LAWFOED, V. F. C. VELEY, AND B. B. PARRISH
1951. Variations in brood-strength in the North Sea haddock, in the light of relevant wind conditions. Nature, Lond., 168: 317-321.
- 1956] Wheatland: VII. Pelagic Fish Eggs and Larvae 311
- CLARK, FRANCES N.
1934. Maturity of the California sardine (*Sardina caerulea*), determined by ova diameter measurements. Fish Bull., Sacramento, 42: 3-49.
- DANNEVIG, ALF
1918. Biology of Atlantic waters of Canada. Canadian fish-eggs and larvae. Canad. Fish. Exped. (1914-15): 3-74.
- DAVIES, D. H.
1954. The South African pilchard (*Sardinops ocellata*). Development, occurrence and distribution of eggs and larvae, 1950-51. Invest. Rep. Div. Fish., Un. S. Afr., No. 15: 5-28.
- DELSMAN, H. C.
1931. Fish eggs and larvae from the Java Sea. 18. The genus *Cybium*. Treubia, 18: 401-410.
- EGE, VILH.
1939. A revision of the genus *Anguilla* Shaw. A systematic, phylogenetic, and geographical study. Dana-Rep. No. 16: 1-256.
- EHRENBAUM, E.
1909. Eier und Larven von Fischen. Nord. Plankt. Lfg. 10, Teil 2: 217-413.
1923. Ueber die Makrele. Laichverhältnisse-Larven und Jungenformen. Nahrung und Feinde. Wiss. Meeresuntersuch., Abt. Helgoland, N. F. 16 (1), Nr. 2: 1-32.
- EINARSSON, HERMANN
1951. The post-larval stages of sand-eels (*Ammodytidae*) in Faroe, Iceland and W-Greenland waters. Acta Nat. Islandica, 1 (7): 5-75.
- FARRAN, G. P.
1938. On the size and number of the ova of Irish herrings. J. Cons. int. Explor. Mer, 13 (1): 91-100.
- FISH, C. J.
1928. Production and distribution of cod eggs in Massachusetts Bay in 1924 and 1925. Bull. U. S. Bur. Fish., 43 (2): 253-296.
- FRIDRIKSSON, A. AND G. TIMMERMANN
1951. Some remarks on the eggs of herring (*Clupea harengus* L.) and capelin (*Mallotus villosus* (O. F. Mull.)) in Icelandic waters. J. Cons. Int. Explor. Mer, 17 (3): 261-263.
- GINSBURG, ISAAC
1950. Review of the western Atlantic Triglidae (Fishes). Tex. J. Sci., 2 (4): 489-527.
- GORBUNOVA, N. N.
1952. The effect of fixation on the size of the eggs of mintai, *Theragra chalcogramma* (Pallas). C. R. Acad. Sci. U.R.S.S., 82 (1): 163-164. (Russian).
- GREELEY, J. R.
1939. A biological survey of the salt waters of Long Island, 1938. Section II. Fishes and habitat conditions of the shore zone based upon July and August seining investigations. Suppl. 28th Ann. Rep. N. Y. State Cons. Dept., Pt. II: 72-91.

- GUNTER, GORDON
1942. A list of the fishes of the mainland of North and Middle America recorded from both freshwater and sea water. *Amer. Midl. Nat.*, 28 (2): 305-326.
- HILDEBRAND, S. F.
1922. Notes on habits and development of eggs and larvae of the silversides *Menidia menidia* and *Menidia beryllina*. *Bull. U. S. Bur. Fish.* (1921-22), 38: 113-120.
- HILDEBRAND, S. F. AND LOUELLA E. CABLE
1930. Development and life history of fourteen teleostean fishes at Beaufort, N. C. *Bull. U. S. Bur. Fish.*, 46: 383-488.
1934. Reproduction and development of whittings or kingfishes, drums, spot, croaker, and weakfishes or sea trouts family Sciaenidae, of the Atlantic coast of the United States. *Bull. U. S. Bur. Fish.*, 48: 41-117.
1938. Further notes on the development and life history of some teleosts at Beaufort, N. C. *Bull. U. S. Bur. Fish.*, 48: 505-642.
- HILDEBRAND, S. F. AND W. C. SCHROEDER
1928. Fishes of Chesapeake Bay. *Bull. U. S. Bur. Fish.* (1927), 43 (1): 1-366.
- HUBBS, C. L.
1943. Terminology of early stages of fishes. *Copeia*, 1943 (4): 260.
- HUNTSMAN, A. G.
1922. The fishes of the Bay of Fundy. *Contr. Canad. Biol.* (1921), No. 3: 51-72.
- JOHANSEN, FRITS
1925. Natural history of the Cunner (*Tautoglabrus adspersus* Walbaum). *Contr. Canad. Biol.*, N. S. 2 (17): 423-468.
- KISSELWITCH, K. A.
1923. Materials on the biology of the Caspian herrings. I. Fertility of the Wolga-Caspian herrings. *Rep. Astrakh. Ichthy. Lab.*, 5 (1): 15-55.
- KUNTZ, ALBERT
1914. The embryology and larval development of *Bairdiella chrysura* and *Anchovia mitchilli*. *Bull. U. S. Bur. Fish.* (1913), 33: 3-19.
1916. Notes on the embryology and larval development of five species of teleostean fishes. *Bull. U. S. Bur. Fish.* (1914), 34: 407-429.
- KUNTZ, ALBERT AND LEWIS RADCLIFFE
1917. Notes on the embryology and larval development of twelve teleostean fishes. *Bull. U. S. Bur. Fish.* (1915-16), 35: 89-134.
- MACFARLAND, W. E.
1931. A study of the Bay of Fundy herring. *Ann. Rep. Biol. Bd. Canad.* (1930): 22-23.
- MAŃKOWSKI, W.
1948. Comparative studies as to the quantitative distribution of eggs and larvae of *Clupea sprattus* L., *Gadus morrhua* L. and *Onos cimbrius* L. in the Gulf of Gdańsk in 1938, 1946, and 1947. *Bull. Lab. Marit. Gdynia*, No. 4: 155-170.
- MARSHALL, NELSON
1946. Observations on the comparative ecology and life history of two sea robins, *Prionotus carolinus* and *Prionotus evolans strigatus*. *Copeia*, 1946 (3): 118-144.

- MARSHALL, N. B.
1953. Egg size in Arctic, Antarctic and deep-sea fishes. *Evolution*, 7 (4): 328-341.
- MASSMAN, W. H.
1954. Marine fishes in fresh and brackish waters of Virginia rivers. *Ecology*, 35 (1): 75-78.
- MERRIMAN, DANIEL
1947. Notes on the midsummer ichthyofauna of a Connecticut beach at different tide levels. *Copeia*, 1947 (4): 281-286.
- MERRIMAN, DANIEL AND RUTH C. SCLAR
1952. Hydrographic and biological studies of Block Island Sound. The pelagic fish eggs and larvae of Block Island Sound. *Bull. Bingham oceanogr. Coll.*, 13 (3): 165-219.
- MOORE, EMMELINE
1947. Studies on the marine resources of southern New England. VI. The sand flounder, *Lophossetta aquosa* (Mitchill); a general study of the species with special emphasis on age determination by means of scales and otoliths. *Bull. Bingham oceanogr. Coll.*, 11 (3): 1-79.
- MORROW, J. E.
1951. Studies on the marine resources of southern New England. VIII. The biology of the longhorn sculpin, *Myoxocephalus octodecimspinosus* Mitchell, with a discussion of the southern New England "trash" fishery. *Bull. Bingham oceanogr. Coll.*, 13 (2): 1-89.
- NICHOLS, J. T. AND C. M. BREDER, JR.
1926. The marine fishes of New York and southern New England. *Zoologica*, N. Y., 9 (1): 1-192.
- PERLMUTTER, ALFRED
1939. A biological survey of the salt waters of Long Island, 1938. Section I. An ecological survey of young fish and eggs identified from tow-net collections. *Suppl. 28th Ann. Rep. N. Y. Cons. Dept.*, Pt. II: 11-71.
- RANEY, E. C. AND W. H. MASSMAN
1953. The fishes of the tidewater section of the Pamunkey River, Virginia. *J. Wash. Acad. Sci.*, 43 (12): 424-432.
- RASS, T. S.
1941. Analogous or parallel variations in structure and development of fishes in northern and arctic seas. *Jub. Publ. Moscow Soc. Nat.*, 1805-1940: 1-60.
- RILEY, G. A.
1952a. Hydrographic and biological studies of Block Island Sound. Hydrography of Long Island and Block Island Sounds. *Bull. Bingham oceanogr. Coll.*, 13 (3): 5-39.
1952b. Hydrographic and biological studies of Block Island Sound. Phytoplankton of Block Island Sound, 1949. *Bull. Bingham oceanogr. Coll.*, 13 (3): 40-64.
- RUSSELL, F. S.
1926. The vertical distribution of the marine macroplankton. III. Diurnal observations on the pelagic young of teleostean fishes in the Plymouth area. *J. Mar. biol. Ass. U. K.*, 14: 387-414.

- SETTE, O. E.
1943. Biology of the Atlantic mackerel (*Scomber scombrus*) of North America. Pt. I. Early life history, including the growth, drift, and mortality of the egg and larval populations. *Fish. Bull. Fish Wildl. Serv.*, 50, No. 38: 149-237.
- SHERWOOD, S. H. AND V. M. EDWARDS
1901. Notes on the migration, spawning, abundance, etc., of certain fishes in 1900. *Biol. Notes*. No. 2, in *Bull. U. S. Fish. Comm.* (1901), 21: 27-31.
- SILLIMAN, R. P.
1943. Thermal and diurnal changes in the vertical distribution of the eggs and larvae of the pilchard (*Sardinops caerulea*). *J. Mar. Res.*, 5 (2): 118-130.
1946. A study of variability in plankton tow-net catches of Pacific pilchard (*Sardinops caerulea*) eggs. *J. Mar. Res.*, 6 (1): 74-83.
- SUMNER, F. B., R. C. OSBURN, AND L. J. COLE
1913. A biological survey of the waters of Woods Hole and vicinity. Pt. 2, Sect. 3. A catalogue of the marine fauna. *Bull. U. S. Bur. Fish.* (1911), 31: 549-794.
- TOOTS, HENDRIK
1951. Number of eggs in different populations of whitefish (*Coregonus*). *Ann. Rep. Inst. Freshwater Res. Drottning.* (Fish. Bd. Sweden), No. 32 (1950): 133-138.
- U. S. FISH AND WILDLIFE SERVICE
1951-1952. Fishery statistics of the United States. W. W. Anderson and E. A. Power, eds., 1941-1952.
- U. S. DEPT. OF COMMERCE, WEATHER BUREAU
1952-1953. Local Climatological Data. Station New Haven, Conn.
- WALFORD, L. A.
1938. Effect of currents on distribution and survival of the eggs and larvae of the haddock (*Melanogrammus aeglefinus*) on Georges Bank. *Bull. U. S. Bur. Fish.*, 49 (29): 1-73.
- WARFEL, H. E. AND DANIEL MERRIMAN
1944. Studies on the marine resources of southern New England. I. An analysis of the fish population of the shore zone. *Bull. Bingham oceanogr. Coll.*, 9 (2): 1-91.
- WELSH, W. W. AND C. M. BREDER, JR.
1922. A contribution to the life history of the puffer, *Spheroides maculatus* (Schneider). *Zoologica*, N. Y., 2 (12): 261-276.
1923. Contributions to life histories of Sciaenidae of the eastern United States coast. *Bull. U. S. Bur. Fish.* (1923-24), 39: 141-201.
- WINSOR, C. P. AND G. L. CLARKE
1940. A statistical study of variation in the catch of plankton nets. *J. Mar. Res.*, 3 (1): 1-34.
- WINSOR, C. P. AND L. A. WALFORD
1936. Sampling variations in the use of plankton nets. *J. Cons. int. Explor. Mer.*, 11 (2): 190-204.

OCEANOGRAPHY OF LONG ISLAND SOUND, 1952-1954

VIII. CHEMICAL COMPOSITION OF THE PLANKTON

BY

EUGENE HARRIS

Osborn Zoological Laboratory and Bingham Oceanographic Laboratory

AND

GORDON A. RILEY

Bingham Oceanographic Laboratory

TABLE OF CONTENTS

	<i>Page</i>
ABSTRACT.....	315
INTRODUCTION.....	316
METHODS.....	316
<i>Sampling</i>	316
<i>Analytical</i>	317
RESULTS.....	318
<i>Phytoplankton</i>	318
<i>Zooplankton</i>	321
DISCUSSION.....	322
REFERENCES.....	323

ABSTRACT

Net plankton samples, collected occasionally during 1953 from the central part of Long Island Sound, were analyzed for wet and dry weight, ash, chlorophyll, total phosphorus and total nitrogen. The phytoplankton samples showed seasonal variations in ash which are explained by changes in the relative abundance of certain species; they also showed variations in chlorophyll, which may be explained as an adaptation of the phytoplankton to seasonal changes in illumination. In contrast to ash and chlorophyll, the nitrogen and phosphorus remained relatively constant throughout the year, although the average N:P ratios for the two groups were different. These ratios are discussed in relation to the inorganic nutrient supply of the Sound.

INTRODUCTION

Routine plankton observations, comprising counts, chlorophyll analyses, and zooplankton displacement volumes, have provided the main basis for the description of plankton distribution and seasonal variation in Long Island Sound. However, it was decided that additional measurements of wet and dry weight, ash, chlorophyll, total phosphorus, and total nitrogen on a few plankton samples would facilitate studies on the dynamic aspects of production and utilization of plankton and on the transformation of nutrients in the Sound. Samples were collected periodically during 1953 at the locations and dates listed in Table I. While only a few samples were taken, it was hoped that they would reveal any large seasonal fluctuations in chemical composition, which, if they existed, would affect the dynamic studies just mentioned.

In addition to the weights and chemical measurements, the species composition of the phytoplankton samples was determined, since it seemed likely that species variations might have some effect on the results. The counts were made by Shirley M. Conover, and her help is gratefully acknowledged.

METHODS

Sampling. All samples, phytoplankton and zooplankton, were obtained by surface tows. The phytoplankton samples were collected in a net of bolting silk, 30 cm in diameter, which had a pore size of 75μ and which retained the larger members of the phytoplankton population. A second net with a larger pore size of 415μ was suspended inside the phytoplankton net, and this served to screen and thus eliminate the larger zooplankton from the phytoplankton sample. In order to catch the smaller phytoplankton as well, it would have been necessary to use a net with a pore size smaller than 75μ , but this was impossible since such a net would have retained large quantities of detritus. The zooplankton samples that were used for the analyses were collected in another net, 40 cm in diameter, with a pore size of 415μ which retained only the larger members of the zooplankton population. Unfortunately, it was practically impossible to obtain a quantitative separation of the two plankton groups because of their overlap in size, especially in summer. It was also difficult to obtain a phytoplankton sample of workable size except in the spring flowering period.

Contamination of the June 1 phytoplankton samples by zooplankton and detritus explains the high phosphorus and nitrogen and the low ash and chlorophyll relative to those values obtained for other phytoplankton samples. This sample had a zooplankton count which was 15% that of the phytoplankton count; and, since the zooplankton were the larger organisms, the percentage of zooplankton organic matter in the sample was probably much greater than 15%.

Analytical. The zooplankton samples were filtered under suction on No. 10 bolting silk, the phytoplankton samples on No. 20 bolting silk. The sample was washed with a small volume of distilled water and suction was reapplied to remove as much water as possible before determining the wet weight. The dry weights were determined after the samples had been dried in an oven at 95° C. Since there was considerable error in the wet weight determinations, especially for phytoplankton, all chemical analyses are referred to the dry weights.

The percentage of organic matter, which is assumed to equal the loss in weight upon ignition, was determined on a fraction of each sample. Suspensions of fresh phytoplankton catches were used to determine the chlorophyll content, as described in this volume by Riley and Conover.

Nitrogen and phosphorus analyses were carried out on 10–15 mg fractions of the dried samples. For nitrogen, samples were digested with 0.2 ml H_2SO_4 and 4–5 drops H_2O_2 , the amount of ammonia then being determined by the standard micro-Kjeldahl method as described by Pregl (1930: 109–118).

At first, phosphorus samples were digested with nitric and perchloric acids, followed by 3 ml HCl so as to volatilize arsenic prior to the determination of phosphorus by the modified Denigés-Atkins method. Because the phosphorus content of the samples appeared low, the digestion method was checked against the sulfuric acid-hydrogen peroxide method that was used for the nitrogen determinations. The latter method gave higher values. Cooper (1934) attributed the low results obtained in certain oxidation methods to interference in color development by oxidizing agents remaining in the mixture. An investigation of the nitric-perchloric method revealed that it could give values for phosphorus that were equal to those obtained by the sulfuric acid-hydrogen peroxide method provided greater care was taken to prevent loss of perchloric acid fumes from the digesting mixture, to get rid of *all* nitric acid after digestion was

TABLE I. CHEMICAL COMPOSITION OF PHYTOPLANKTON AND ZOOPLANKTON

Phytoplankton		Percent Dry Weight						Percent Organic Matter				
Sts.*	Date	Dry Wt. (% Wet Wt.)	Org. matter	Ash	Chlor.	P	N	Chlor.	P	N	N:P	
8	Jan. 27	19.0	29.6	70.4	0.35	0.33	2.25	1.19	1.11	7.6	6.8:1	
2	Feb. 18	14.6	27.3	72.7	0.40	0.26	2.33	1.47	0.95	8.5	9.1:1	
1, 2	Mar. 9	16.2	27.2	72.8	0.40	0.36	2.87	1.47	1.32	10.5	8.0:1	
1, 2	Mar. 23	10.2	38.2	61.8	0.55	0.27	2.09	1.44	0.71	5.5	7.9:1	
5	June 1	29.0	57.3	42.7	0.15	0.73	4.77	0.26	1.27	8.3	6.6:1	
N.H.H.	July 7(a)	17.3	71.6	28.4	0.31	0.57	4.15	0.43	0.80	5.8	7.3:1	
N.H.H.	July 7(b)	19.3	49.1	50.9	0.30	0.64	4.43	0.60	1.30	9.0	7.0:1	
2, 8	Aug. 4	8.0	38.6	61.4	0.16	0.48	2.73	0.41	1.24	7.1	5.9:1	
8	Feb. 1	10.5	30.9	69.1	0.33	0.32	2.24	1.07	1.03	7.0	7.0:1	
	Average	16.0	41.1	58.9	0.33	0.44	3.10	0.93	1.08	7.7	7.3:1	
Zooplankton												
5	Jan. 19	9.4	—	—	—	—	0.97	10.80	—	—	11.1:1	
8	Jan. 27	12.1	85.9	14.1	—	—	0.87	9.96	1.04	11.0	10.6:1	
8	Apr. 15	10.9	78.6	21.4	—	—	0.70	9.25	0.89	11.7	13.1:1	
8	Apr. 15	8.9	72.0	28.0	—	—	0.69	8.37	0.96	11.6	12.1:1	
2	July 7	12.6	87.3	12.7	—	—	1.05	9.78	1.20	11.2	9.3:1	
5	Nov. 23	8.0	74.5	25.5	—	—	0.59	5.56	0.79	7.5	9.5:1	
	Average	10.3	79.7	20.3	—	—	0.82	8.91	0.98	10.6	10.9:1	

* Numbered stations are routine stations shown in Fig. 1 of Riley's INTRODUCTION to this volume. N.H.H. refers to New Haven Harbor.

completed, and to wash the precipitate in the digested sample three or four times. The results in Table I were obtained with the sulfuric acid-hydrogen peroxide method, with an additional step of volatilizing arsenic with HCl.

RESULTS

The results of chemical analyses are summarized in Table I.

Phytoplankton. The ash averages 58.9% of the dry weight, with a slightly higher average of 69.4% for the five winter samples. This indication of a seasonal trend agrees with the findings of other investigators. For example, Moberg (1928) reported that the average ash content of net phytoplankton in California waters was 75% of the dry weight between October and February and 25.5% from May to June. Table II shows that: the seasonal trend results from changes in species composition of the samples; the winter phytoplankton samples are almost solely diatoms, of which a single species, *Skeletonema costatum*, makes up 72%, 82.7%, 96.6% and 72.2% of the total cell count in the Jan. 27, Feb. 18, Mar. 9 and Mar. 23 samples respectively; the summer samples contain large proportions of other

TABLE II. SPECIES COMPOSITION OF THE PHYTOPLANKTON SAMPLES IN PERCENTAGES OF THE TOTAL CELL COUNT

	Collection dates							
	I/27	II/18	III/9	III/23	VI/1	VII/7	VII/7	VIII/4
<i>Skeletonema costatum</i>	72.1	82.7	96.6	72.2	1.8	—	—	—
<i>Thalassiosira decipiens</i>	8.1	4.6	0.7	—	3.1	—	—	—
<i>T. nordenskiöldii</i>	2.3	2.4	—	8.7	—	—	—	—
<i>Thalassiosira nitzschoides</i>	9.5	5.2	0.3	1.0	1.1	—	—	0.5
<i>Lauderia borealis</i>	—	—	—	8.9	—	—	—	—
<i>Melosira sulcata</i>	4.5	1.8	0.6	1.3	1.3	—	—	—
<i>Nitzschia closterium</i>	—	—	—	—	—	26.6	14.3	—
<i>N. pungens</i> var. <i>atlantica</i>	—	—	—	—	6.0	—	—	—
<i>Asterionella japonica</i>	0.3	—	—	3.3	—	8.7	0.6	—
<i>Chaetoceros affinis</i>	0.2	—	—	—	—	—	—	8.6
<i>C. curvisetus</i>	0.3	—	—	—	—	—	—	5.9
<i>C. compressus</i>	0.8	0.7	—	—	—	—	—	1.1
<i>C. danicus</i>	—	—	—	1.3	2.7	—	—	—
<i>C. decipiens</i>	—	—	—	0.6	18.0	—	2.8	64.0
<i>C. radicans</i>	—	—	—	0.6	—	—	—	—
<i>Coscinodiscus radiatus</i>	—	—	—	—	—	—	—	2.7
<i>C. perforatus</i> var. <i>cellulosa</i>	—	—	—	—	—	—	—	3.6
<i>C. centralis</i> var. <i>pacifica</i>	—	—	—	—	—	3.1	34.5	2.6
<i>Rhizosolenia delicatula</i>	0.2	—	—	—	4.5	—	—	—
<i>Prorocentrum scutellum</i>	—	—	—	—	—	—	—	8.7
<i>Thalassiosira gravida</i>	—	—	—	—	—	—	—	1.4
<i>T. rotula</i>	—	—	—	—	1.1	—	1.0	—
<i>Peridinium trochoideum</i>	—	—	—	—	53.3	—	—	—
<i>Goniaulax africana</i> (?)	—	—	—	—	1.1	43.8	32.1	—
<i>G. cochlea</i>	—	—	—	—	—	6.1	10.8	—
<i>Ezuriella</i> spp.	—	—	—	—	—	2.0	1.6	—
Unidentified pennate diatoms	—	—	—	—	—	8.7	0.6	—
Total	98.3	97.4	98.2	97.9	94.0	99.0	98.3	99.1

phytoplankton, especially dinoflagellates, of which *Goniaulax* spp. make up about half the cell count in the two July samples. A larger percentage of ash from diatoms accounts for the higher ash content in the winter samples.

It would be interesting to know the relative proportions of the various constituents of diatoms and dinoflagellates that coexist in nature, since most data are acquired from pure cultures of single species. Table III represents a rough approximation of the composition of *Goniaulax* and *Coscinodiscus* as calculated from the July 7(a) and 7(b) samples. These genera make up the greater percentage of the total cell count of these two samples and, since they are the only large forms present in appreciable numbers, it may be assumed that they represent the entire volumes of the samples. An equation is set up for each sample, using the number of cells of each genus in the sample as coefficients for the chemical component to be solved; these are then equated to the total weight of that component in the

sample. The two equations are solved simultaneously. For example:

$$(a) 0.12x + 5.42y = 244.5$$

$$(b) 4.99x + 6.27y = 895.5,$$

where x = weight in mg of 10^6 *Coscinodiscus* cells, y = weight in mg of 10^6 *Goniaulax* cells and where 244.5 and 895.5 are the wet weights in milligrams of the July 7(a) and 7(b) samples respectively. As a check on the algebraic method, the wet weight per million cells is converted to an estimate of volume by assuming a specific gravity of 1.03 which is then compared with observed volumes. While calculated and observed dimensions vary slightly, the correction

TABLE III. COMPOSITION OF *Goniaulax* AND *Coscinodiscus*

	Mg/10 ⁶ cells		Percent Dry Weight		Percent Organic Matter	
	Gon.	Cosc.	Gon.	Cosc.	Gon.	Cosc.
Wet weight	42.3	126.3	—	—	—	—
Dry weight	7.2	25.7	—	—	—	—
Organic matter	5.3	10.6	73.6	41.2	—	—
Ash	1.9	15.1	26.4	58.8	—	—
Chlorophyll	0.022	0.075	0.31	0.29	0.41	0.65
Nitrogen	0.298	1.166	4.14	4.53	5.62	11.00
Phosphorus	0.041	0.171	0.57	0.66	0.77	1.61

	<i>Goniaulax</i>	<i>Coscinodiscus</i>
Calculated diameter μ	46 x 36	85
Observed diameter μ	35 x 28	50 — 160 mean about 110 μ

for which would decrease the weight of *Goniaulax* and increase that of *Coscinodiscus*, the results are sufficiently accurate to give some indication of the differences between diatoms and dinoflagellates. The data in Table III support the conclusion that seasonal variations in ash are due to changes in relative abundance of certain species, since *Goniaulax* has only half as much ash as *Coscinodiscus*.

That there is some seasonal variation in chemical composition is borne out by the chlorophyll values. When the chlorophyll percentages for the five winter and four summer samples are averaged separately, chlorophyll comprises 1.33% of the organic content in winter and 0.43% in summer. If we assume that 4.4 Harvey Units of plant pigment are equivalent to 1 μ g chlorophyll (see Riley and Conover's paper), then the winter samples average 5850 HU/mg P, the summer samples 1850 HU/mg P. These values are considerably

lower than the 12500 HU/mg P reported by Harvey, *et al.* (1935) for the spring flowering period in the English Channel.

In contrast to chlorophyll, phosphorus and nitrogen do not show a regular seasonal variation. Variations from sample to sample may be as great as 100%, but this is much less than the 300% difference between summer and winter chlorophyll. However, Table III indicates that there are variations between species and that summer diatoms may be richer in nitrogen and phosphorus than winter diatoms. The ratio of nitrogen to phosphorus averages 7.3:1 by weight or 16.7:1 by atoms, with relatively small deviations. This average agrees well with Fleming's average of 7:1 (Fleming, 1939).

Zooplankton. Table I reveals that zooplankton have a more nearly uniform composition throughout the year than phytoplankton. The April 15 and November 23 samples are undoubtedly contaminated with phytoplankton, since both contain precipitates which must be centrifuged out after digestion of the samples. Copepods made up about 95% of the zooplankton in the samples, and contamination by phytoplankton may explain why the average ash content was higher and the phosphorus and nitrogen values lower than one would expect for copepods, considering values quoted by Vinogradov (1953: 381-387). Vinogradov's figures¹ for *Calanus finmarchicus* are 9.0-10.2% N and 1.02% P as percentage dry weight, while the Long Island Sound samples are 8.91% N and 0.82% P. The difference is accentuated by the higher ash content of the Sound samples, but both give a N:P ratio of 11:1. When the November sample is omitted from consideration, the percentage of nitrogen in the organic matter is very constant.

Fleming's average N:P ratio of 7.4:1 for zooplankton is much lower than that of the Long Island Sound zooplankton. Fleming points out that there is no reason why the ratio should be the same in phytoplankton and zooplankton, since the latter are physiologically much more complicated than single cell organisms, yet it is shown in the following discussion that the phytoplankton are able to maintain a fairly constant ratio under quite different environmental conditions. Average N:P ratios are calculated from only a few analyses which vary from author to author and species to species, hence such over-all averages probably have no validity when applied to a particular area.

¹ Recalculated from Vinogradov's P₂O₅ values.

DISCUSSION

Redfield (1934) was the first to point out that the ratio of inorganic N:P in ocean water is nearly constant and is identical to the ratio of these elements in plankton. He also pointed out that limited bodies of water may have lower N:P ratios than average ocean water, and he has presented data that show a ratio of 10:1 by atoms for the English Channel. In the Sound a still more extreme condition has been noted (see Riley and Conover's paper). The maximum N:P ratio in winter is about 8:1, and for several months following the spring phytoplankton flowering, nitrate is almost entirely depleted² while considerable phosphate remains. However, the data show that the ratio of N:P in Long Island Sound phytoplankton is almost constant within analytical error and that this ratio is strikingly close to that of open ocean water in spite of the dissimilar N:P ratios of these two types of water.

In the laboratory, Ketchum (1939, 1949) found that pure cultures of phytoplankton grown in a nitrogen-deficient medium showed a decrease below the normal nitrogen content; *Chlorella pyrenoidosa* contained as little as 2.25–2.72% N in their ash free dry weight; when the deficient cultures were returned to media containing adequate nitrogen, the nitrogen content reverted back to about 7.7%, which is normal for *Chlorella pyrenoidosa* in cultures as well as nature. Moreover, this deficiency can be made up in the dark as well as in light, and this led Harvey (1945) to suggest that while phytoplankton may become nutrient deficient during the day, such deficiency may be made up at night. This would enable populations to absorb nutrients continuously from media with low concentrations while carbon fixation would proceed only in daylight, thus maintaining the required nitrogen and phosphorus concentrations in the organic matter. Such a mechanism, coupled with rapid replenishment of nutrients in a shallow basin like the Sound where there is continuous mixing of bottom water and considerable land drainage, may explain how the phytoplankton maintain a nitrogen content which is the same as that of ocean plankton where the N:P ratio in the water is greater.

Recent physiological experiments (Harvey, 1953) may also explain why chlorophyll, as opposed to nitrogen and phosphorus, undergoes a marked seasonal variation. The data in Table III show that seasonal changes in dominant species do not explain this variation, since both diatoms and dinoflagellates contain about the same amount

² Preliminary analyses show that some nitrogen is available in the form of ammonia.

of chlorophyll. Working on pure cultures of *Nitzschia closterium*, Harvey demonstrated that the amount of chlorophyll synthesized was a function of the amount of illumination, only half of the chlorophyll being produced when the illumination was increased six times. This situation is apparently a complex one, since nitrogen deficiency in addition to increased illumination will also decrease chlorophyll synthesis; Harvey emphasizes that both factors together do not completely explain the problem. However, on the basis of these experiments, it is logical to expect a threefold decrease in the chlorophyll content of summer phytoplankton in an area like Long Island Sound where there is approximately a ninefold increase in summer illumination over winter illumination.

REFERENCES

- COOPER, L. H. N.
1934. The determination of phosphorus and nitrogen in plankton. *J. Mar. biol. Ass. U. K.*, (NS) 19: 755–760.
- FLEMING, R. H.
1939. Composition of plankton and units for reporting populations and production. *Proc. 6th Pac. sci. Congr.*, 3: 535–540.
- HARVEY, H. W.
1945. Recent advances in the chemistry and biology of sea water. Cambridge Univ. Press. 164 pp.
1953. Synthesis of organic nitrogen and chlorophyll by *Nitzschia closterium*. *J. Mar. biol. Ass. U. K.*, (NS) 31: 477–487.
- HARVEY, H. W., L. H. N. COOPER, M. V. LEBOUR AND F. S. RUSSELL
1935. Plankton production and its control. *J. Mar. biol. Ass. U. K.*, (NS) 20: 407–441.
- KETCHUM, B. H.
1939. The development and restoration of deficiencies in phosphorus and nitrogen composition of unicellular plants. *J. cell. comp. Physiol.*, 13: 373–381.
1949. Some physical and chemical characteristics of algae grown in mass culture. *J. cell. comp. Physiol.*, 33: 281–300.
- MOBERG, E. G.
1928. Chemical composition of marine plankton. *Proc. 3rd Pan-Pac. sci. Congr.*, 1: 233–236.
- PREGI, FRITZ
1930. Quantitative organic microanalysis. 2nd Eng. Ed., P. Blakiston's Son and Co., Philadelphia. 237 pp.
- REDFIELD, A. C.
1934. On the proportions of organic derivatives in sea water and their relation to the composition of plankton. *James Johnstone Memor. Vol.*, Univ. Liverpool: 176–192.
- VINOGRADOV, A. P.
1953. The elementary chemical composition of marine organisms. *Mem. Sears Found. Mar. Res.*, II. 647 pp.

OCEANOGRAPHY OF LONG ISLAND SOUND, 1952-1954

IX. PRODUCTION AND UTILIZATION OF ORGANIC MATTER

By

GORDON A. RILEY

Bingham Oceanographic Laboratory

TABLE OF CONTENTS

ABSTRACT.....	324
INTRODUCTION.....	325
ANALYSIS OF NET CHANGES IN PHOSPHATE.....	326
NET CHANGES IN OXYGEN.....	331
OXYGEN PRODUCTION AND CONSUMPTION.....	332
PHOSPHATE UTILIZATION AND REGENERATION.....	336
DISCUSSION.....	337
REFERENCES.....	343

ABSTRACT

The observed distribution of oxygen and phosphate was used to calculate the net biological rates of change of these elements on a seasonal basis. With the aid of experimental data and some arbitrary assumptions, the net changes were converted to estimates of total plant production and utilization of organic matter by various components of the marine association.

The total annual fixation of carbon by photosynthesis is estimated to be about 470 g/m². Over half of it is consumed in phytoplankton respiration. Of the estimated 205 g C/m² available for the remainder of the population, 26% appears to be used by that part of the zooplankton taken with a No. 10 net, 43% by microzooplankton and bacteria in the water column, and 31% by the benthic fauna and flora.

Although plankton concentrations are large, Long Island Sound does not appear to be superior in total productivity to adjacent open coastal waters. Comparison with Harvey (1950) indicates that phytoplankton production in Long Island Sound is at least twice as large as that in the English Channel, but it appears to be used less efficiently by the animal population.

INTRODUCTION

The 1952-1954 survey has been concerned primarily with descriptions of the standing plankton crop in the central part of Long Island Sound and of accompanying environmental characteristics of the water. Some information on the more difficult subject of biodynamics has been provided by experiments in the preceding papers of this volume and by a previous study of Long Island Sound (Riley, 1941). The distribution of nonconservative properties is also potentially useful in assessing the rates of production and utilization of biological materials. A preliminary analysis of the available information appears to be warranted, although the subject will need to be re-examined when the remainder of the survey has been completed.

Before taking up the problem in detail, some general principles should be discussed briefly. It is generally agreed that the local time change in oxygen, phosphate, or other nonconservative concentrations is the sum of: (a) a biological rate of change attendant upon plant growth; (b) an opposite change due to the katabolic activity of the biological association as a whole; and (c) a physical rate of change caused by admixture of water with a different concentration. The study of productivity requires isolating and measuring (a), (b), or both. Historically this has been accomplished in several different ways:

(1) During the spring flowering, phytoplankton growth is pre-eminent. Katabolic processes are at a low ebb, at least in the beginning. In shallow, turbulent water, where nutrients are reduced from surface to bottom, vertical diffusion effects may be ignored. Therefore, the observed change in a nonconservative concentration is a minimal but nearly accurate measure of phytoplankton productivity.

(2) The experimental technique of light and dark bottles aims at complete isolation. Enclosure in bottles eliminates (c). The light bottle measures (a) - (b). The dark bottle measures (b). Light + dark = (a). Against these theoretical advantages are opposed certain technical disadvantages. There are experimental errors, particularly with respect to growth of bacteria in enclosed samples. Sampling errors tend to be extreme, for the amount of experimental data that can be accumulated is a small fraction of the number of routine descriptive observations that can be obtained with an equal amount of effort.

(3) Physical oceanographic methods may be used to determine advection and diffusion coefficients, and these may be combined with observed gradients in nonconservative concentrations to evaluate (c). Then local time change $-(c) = (a) - (b)$. The significance of this method from the standpoint of biodynamics depends upon the fact that (a) is generally much larger than (b) in the surface layer, while in deeper water (a) becomes negligibly small. Thus it may be possible to derive an estimate of total productivity, but the complex nature of the problem generally necessitates some arbitrary assumptions.

In this paper the net changes (a) - (b) of oxygen and phosphate will be determined for a series of depths in the central part of Long Island Sound according to method (3), using observed distributions of these elements and assuming that the coefficients of vertical eddy diffusivity are equal to the conductivity coefficients calculated in a previous paper in this series (Riley: PHYSICAL OCEANOGRAPHY). Further, it will be assumed that lateral transport and diffusion can be ignored. If this assumption introduces serious errors, the estimates will be modified later when the survey of the Sound as a whole has been completed.

ANALYSIS OF NET CHANGES IN PHOSPHATE

Allowing the simplifying assumptions listed above, the local time change in phosphorus P is given in differential form by

$$\frac{\partial P}{\partial t} = R + \frac{\partial}{\partial z} \cdot \frac{A}{\rho} \frac{\partial P}{\partial z}, \quad (1)$$

where A is the coefficient of vertical eddy diffusivity, z is depth, and R is the net rate of biological change, equivalent to (a) - (b) in the discussion above. Written in terms of finite differences,

$$\frac{\partial P_0}{\partial t} = R + \frac{1}{z} \left(\frac{A_z}{\rho} \cdot \frac{P_z - P_0}{z} - \frac{A_{-z}}{\rho} \cdot \frac{P_0 - P_{-z}}{z} \right). \quad (2)$$

Here P_0 is defined as the phosphorus concentration at a given depth; P_{-z} and P_z are the concentrations at a distance z above and below, respectively, the vertical axis being directed positively downward. A_{-z} and A_z are the corresponding average coefficients of eddy diffusivity for the distances z above and below P_0 .

Equation (2) is suitable for determining the rate of change of phosphorus at intermediate depths. It is essential also to determine the rate of biological events in the immediate surface and bottom layers. For this purpose a flux equation is postulated,

$$F = - \frac{A}{\rho} \cdot \frac{\partial P}{\partial z}, \quad (3)$$

which is analogous to the heat transfer equation in the earlier paper on PHYSICAL OCEANOGRAPHY and which may be presented in finite difference form similar to equation (2). It provides a method for determining the amount of vertical movement of phosphate in unit time through a square centimeter of horizontal area, and any difference between the amount transferred and the observed change in concentration may be interpreted as a biological transformation.

In applying equations (2) and (3), the following data are available:

1. Average coefficients of eddy conductivity have been calculated for specific depth ranges and for periods of one to three months. The calculations cover all of the two-year survey period except the autumn seasons, when, for reasons previously discussed, the method was unsuitable.

2. The observed phosphate concentrations at the beginning and end of each time interval will be used to calculate the rate of change $\partial P_0 / \partial t$.

3. Average vertical gradients during each time interval will be determined, using all available analyses except a few that show obvious and gross contamination.

As a numerical example of the method of utilizing these data, we shall estimate the biological rate of change of phosphate at the 5 m level at Sts. 2 and 4 during the period of May 21 to August 19, 1952, using mean values for the two stations. On May 21 the observed phosphate concentration at 5 m was 0.51 $\mu\text{g-at } P/l$; it increased to 1.00 $\mu\text{g-at } P$ on August 19. During the entire period, the average vertical gradient in phosphate was 0.052 $\mu\text{g-at}$ between 0 and 5 m and 0.209 $\mu\text{g-at}$ between 5 and 10 m. The calculated mean coefficients of eddy diffusivity (conductivity) for the same depth ranges were 0.75 and 0.68 $\text{g cm}^{-1} \text{sec}^{-1}$, respectively. The time interval was 7.78×10^6 seconds. The density of the water was about 1.02. In accordance with the rest of the cgs notation, phosphate concentrations are multiplied by 10^{-3} . According to equation (2),

$$\frac{(1.00 - 0.51)10^{-3}}{7.78 \times 10^6} = R + \frac{1}{500} \left(\frac{.68}{1.02} \cdot \frac{.209 \times 10^{-3}}{500} - \frac{.75}{1.02} \cdot \frac{.052 \times 10^{-3}}{500} \right)$$

$$R = -0.341 \times 10^{-9} \mu\text{g-at } P \text{ cm}^{-3} \text{ sec}^{-1},$$

or a net utilization of 0.03 $\mu\text{g-at } P/l$ in a day.

Suppose that in a column of water 20 m deep, sampled at 5 m intervals, similar calculations are made for the 10 and 15 m levels. A rough numerical integration may then be made, the simplest way being to assume that the 5 m value is the average for the depth range of 2.5 to 7.5 m, etc. The whole water column may thus be accounted for, except the part above 2.5 and below 17.5 m. These require the use of equation (3). In the depth range between 0 and 5 m,

$$F = -\frac{.75}{1.02} \cdot \frac{.052 \times 10^{-3}}{500} = -.076 \times 10^{-6} \mu\text{g-at } P \text{ cm}^{-2} \text{ sec}^{-1}.$$

This is the average rate of upward (negative) movement between 0 and 5 m, and as in previous calculations of eddy conductivity, it is assigned to the midpoint in the stratum, namely 2.5 m.

During the same period, the surface concentration of phosphate increased from 0.30 to 0.99 $\mu\text{g-at } P/l$, which is equivalent to an increase of $0.022 \times 10^{-6} \mu\text{g-at } P/\text{sec}$. in a column of water 2.5 m long and with a cross section of 1 cm^2 . The difference between the calculated flux into this column ($.076 \times 10^{-6}$) and the observed increase is assumed to represent net utilization of phosphate by the biological association. It amounts to about 0.02 $\mu\text{g-at } P/l$ in a day.

Within this general framework, which is fixed by the nature of the problem and the available data, there is a choice as to whether each station should be treated individually or whether some attempt should be made to combine stations. The latter course seemed desirable in order to minimize effects of lateral movements, to average out sampling errors, and to obtain a single generalized result for the central part of the Sound. However, variations in the depth of water at the stations and in the depths sampled required a degree of individual treatment and later combination. Offshore Sts. 3 and 5 were similar in that the total depth of water was 25 to 28 m, and samples were generally taken at 0, 5, 15, and 25 m. One set of data was calculated for these two stations, using averaged observations.

The fact that some of the depth intervals were 5 m and others 10 required a slight alteration in the form of equation (2). A second set was obtained from Sts. 2 and 4, which were slightly shallower and were sampled at 0, 5, 10, and about 20 m. A third set comprised inshore Sts. 1, 7, and 8. St. 6 was too shallow to be usable.

Thus all three sets were available for average estimates of the net rate of change at 5 m and of the vertical flux between 0 and 5 m. Sts. 2 and 4 were used for the 10 m estimate, Sts. 3 and 5 for 15 m. All four offshore stations were averaged to determine vertical flux in a stratum 2.5 m above the bottom, and the latter was assumed for purposes of generalization to be at a depth of 20 m, since that is approximately the mean depth of the area under consideration.

TABLE I. BIOLOGICAL RATE OF CHANGE OF PHOSPHATE IN $\mu\text{g-at } P/\text{DAY}$ IN A VERTICAL COLUMN OF WATER ONE CENTIMETER SQUARE, DIVIDED INTO SEGMENTS OF 2.5 OR 5 m (ONE-QUARTER OR ONE-HALF LITER EACH)

	0-2.5	2.5-7.5	7.5-12.5	12.5-17.5	17.5-20
Mar. 5-May 21, 1952	.000	-.013	-.009	-.001	.009
May 21-Aug. 19	-.006	-.009	-.012	.009	.033
Nov. 17-Feb. 10, 1953	-.008	.001	.004	.004	.000
Feb. 10-Mar. 16	-.008	-.057	-.023	-.026	.002
Mar. 16-May 18	-.012	-.004	.002	-.003	.016
May 18-Aug. 25	-.007	-.004	.005	-.002	.027
Nov. 18-Jan. 25, 1954	-.008	.001	.004	.004	.000
Jan. 25-Feb. 24	-.005	-.050	-.019	-.007	.000

Table I shows estimated net changes in phosphate in the water column and on the bottom. The method of calculation is such that the 17.5 - 20 m segment includes regeneration from one square centimeter of benthic surface at the base of the column. The early autumn periods are omitted from Table I because, as previously mentioned, eddy conductivity could not be determined and presumably had little application to the problem during these periods of extreme convective cooling. During late autumn and early winter, when temperature and phosphate gradients were slight and variable, calculations were possible but were subject to considerable statistical error. To reduce the error as much as possible, data for both years were combined.

Utilization of phosphate in the upper 2.5 m appeared to be relatively uniform throughout the year. Elsewhere there were marked seasonal variations. Maximum utilization occurred during the spring flowering periods, maximum bottom regeneration in summer. In autumn and early winter, utilization exceeded regeneration only in the upper 2.5 m.

An annual summation of net changes is presented in Table II. Each of the daily rates in Table I has been multiplied by the number of days in the period, and the products have been summed for the segments of the column in which net utilization exceeds regeneration and *vice versa*. Figures in parentheses are rough estimates for the autumn periods. First, it was assumed that the net changes in the upper 7.5 m during these periods were intermediate between the preceding summer season and the succeeding late autumn-early winter period. Second, the net change in the whole water column

TABLE II. SUMMATION OF NET CHANGES IN PHOSPHATE— $\mu\text{g-at P/cm}^2$ OF SEA SURFACE

	Utilization		Regeneration		Difference	
	Depth	$\mu\text{g-at P}$	Depth	$\mu\text{g-at P}$	Calc.	Obs.
1952-3						
Mar. 5-May 21	0-17.5	-1.77	17.5-20	.69	-1.08	-.30
May 21-Aug. 19	0-12.5	-2.43	12.5-20	3.79	1.36	1.56
Aug. 19-Nov. 17	0-7.5	(-.90)	7.5-20	(2.83)	(1.84)	1.84
Nov. 17-Jan. 25	0-2.5	-.68	2.5-20	.77	.09	-.94
Jan. 25-Feb. 24	0-17.5	-3.90	17.5-20	.07	-3.83	-2.28
1953-4						
Mar. 5-May 21	0-17.5	-1.07	17.5-20	1.01	-.06	.00
May 21-Aug. 19	0-7.5	-1.09	7.5-20	2.96	1.87	1.44
Aug. 19-Nov. 18	0-7.5	(-.82)	7.5-20	(2.68)	(1.86)	1.86
Nov. 18-Feb. 10	0-2.5	-.54	2.5-20	.61	.07	.10
Feb. 10-Mar. 16	0-17.5	-2.43	17.5-20	.00	-2.43	-2.32
Total						
1952-3	—	-9.77	—	8.15	-1.62	-.12
1953-4	—	-5.95	—	7.26	1.31	1.08
1952-4	—	-15.72	—	15.41	-.31	.96

is known by direct observation, so that by difference one can obtain the net change in the water column below 7.5 m.

During any one period, utilization and regeneration were seldom in balance, as may be seen in the next to the last column in Table II. When any such imbalance exists, it should result in a change in the average phosphate content of the water column. Furthermore, the accuracy of this calculated result is readily checked by comparing it with observed changes in phosphate concentration in the Sound. These are listed in the last column of Table II. The comparison between observed and calculated values is useful in gauging the internal consistency of the results.

NET CHANGES IN OXYGEN

Oxygen concentrations are susceptible to the same type of analysis of net changes. However, any attempt to estimate short-period biological effects in the surface layer is complicated by exchanges of oxygen through the sea surface. Thus Table III omits the upper 2.5 m of the water column. Otherwise the calculations duplicate the phosphate procedure described above.

Rather than attempt calculation of the rate of exchange of oxygen through the sea surface, the writer proposes a simpler alternative method for dealing with the upper 2.5 m. It seems likely that over a period of a year or two, the total production will approximately equal consumption, although an imbalance is likely to exist during

TABLE III. BIOLOGICAL RATE OF CHANGE OF OXYGEN IN MILLILITERS PER DAY IN A VERTICAL COLUMN OF WATER ONE CENTIMETER SQUARE, DIVIDED INTO SEGMENTS OF 2.5 OR 5 M. PARENTHESES INDICATE INTERPOLATIONS TO FILL GAPS IN THE DATA.

	2.5-7.5	7.5-12.5	12.5-17.5	17.5-20
Mar. 5-May 21, 1952	.019	-.004	-.014	-.040
May 21-Aug. 19	.028	.038	-.028	-.132
Aug. 19-Nov. 17	(.009)	(.005)	(-.028)	(-.082)
Nov. 17-Feb. 10, 1953	-.010	-.028	-.027	-.031
Feb. 10-Mar. 16	.064	.025	.015	-.028
Mar. 16-May 18	.014	.010	-.025	-.054
May 18-Aug. 25	.030	-.027	-.028	-.071
Aug. 25-Nov. 18	(.010)	(-.028)	(-.028)	(-.050)
Nov. 18-Jan. 25, 1954	-.010	-.028	-.027	-.028
Jan. 25-Feb. 24	.066	-.004	-.026	-.024

shorter intervals. If the figures in Table III are totalled, it becomes apparent that consumption was considerably larger than production in the water column below 2.5 m. Assuming that the difference is equal to production in the upper 2.5 m, an average value for the latter can be calculated. It is found to be 0.27 ml O_2/l in a day during the first year of the survey and 0.31 ml the second year. By way of comparison, a series of light and dark bottle experiments in the upper meter of water, mainly during the second year (see S. A. M. Conover in this volume), gave an annual mean of 0.31 ml/day for total photosynthesis and 0.20 ml for the net increase in oxygen. A few experiments at other depths or at otherwise reduced light intensity indicated that maximum photosynthesis occurred very near the surface at the time of the spring flowering but frequently at greater depths in summer. In view of these ambiguities in the comparison, the agreement

between experimental results and the physical oceanographic calculation is probably as good as can be expected.

OXYGEN PRODUCTION AND CONSUMPTION

Next an attempt will be made to determine not merely net changes in oxygen but total production and consumption. Table IV brings

TABLE IV. DAILY OXYGEN PRODUCTION AND CONSUMPTION—ml O₂/l

	Net change at 15 m	Experiments Phot. Resp.		Estimated Phyt. Resp.
1952-3				
Mar. 5-May 21	-.028	—	—	.047
May 21-Aug. 19	-.056	—	—	.115
Aug. 19-Nov. 17	—	—	—	.080
Nov. 17-Feb. 10	-.054	—	—	.030
Feb. 10-Mar. 16	.030	.42	.076	.060
1953-4				
Mar. 16-May 18	-.050	.53	.085	.048
May 18-Aug. 25	-.056	.33	.178	.110
Aug. 25-Nov. 18	—	.26	.200	.093
Nov. 18-Jan. 25	-.054	.11	.037	.014
Jan. 25-Feb. 24	-.052	.34	.048	.044

together pertinent information on this problem. First are listed the net changes in oxygen at 15 m, as determined by the physical oceanographic analysis. At this depth photosynthesis probably is negligibly small during the winter months, so that the calculated net change of about 0.05 to 0.06 ml O₂/day may be regarded as synonymous with total oxygen consumption. Also, these figures are probably applicable to the water column as a whole, since there are no marked or consistent vertical variations in the quantity of plankton.

The summer season presents a more difficult problem. In two sets of experiments performed in June 1953, at a series of depths, measurable photosynthesis occurred at 15 m or more. Moreover, one would expect respiration to increase in summer, so that the uniformity of the calculated net changes is suggestive of significant photosynthesis at 15 m throughout the summer season.

The respiratory experiments listed in the third column of Table IV are more or less in agreement with the calculated net changes in winter, but they are much larger in summer. The experimental method is open to criticism of course because of the likelihood of abnormal bacterial growth in the bottles. Thus the two types of measurements

tend to set maximum and minimum limits around the true value for oxygen consumption.

In a previous study of Long Island Sound (Riley, 1941) there was a series of 65 experimental determinations of oxygen production and consumption in light and dark bottles over periods of three or four days. The mean annual production was 0.33 ml/day, nearly the same as that in the present series. The consumption averaged 0.17 ml, as compared with an annual mean of 0.11 ml for the data in Table IV. It is problematical whether this higher value was the result of a longer exposure time or was due to the fact that most of the experiments were performed with inshore water containing relatively large amounts of detritus. A multiple correlation technique was used to estimate phytoplankton and zooplankton respiration and to eliminate unrelated bacterial effects. The statistical result was later shown by Riley, *et al.* (1949) to be in good agreement with the observed respiration of pure diatom cultures. It is also suitable for estimating phytoplankton respiration during the present survey provided a small correction is made for differences in the chlorophyll calibration (cf. Riley and Conover in this volume). The postulated relation between chlorophyll and respiration is shown in Fig. 1A. Applying observed temperatures and chlorophyll concentrations to this curve and averaging the results, we obtain the estimates in the last column of Table IV. It will be noted that these figures are lower than the experimental estimates of total respiration, but they are not markedly lower in the winter and early spring, when zooplankton and bacterial respiration are presumably at a minimum. It is also evident that the estimated phytoplankton respiration in summer exceeded the net change in oxygen at 15 m.

These figures will be used later to determine the proportion of photosynthetic production that is required for immediate use by the phytoplankton. Total respiration remains something of an enigma, but the body of evidence favors a compromise between calculated net changes and black bottle experiments. It will be assumed provisionally that (a) the mean annual respiration is 0.106 ml O₂/l/day as determined by experiment; (b) gaps in experimental data will be filled by substituting figures for the corresponding period of the following year; (c) the net change at 15 m will be adopted for any period when it exceeds the experimental value; and (d) during other periods the experimental data will be reduced by a constant

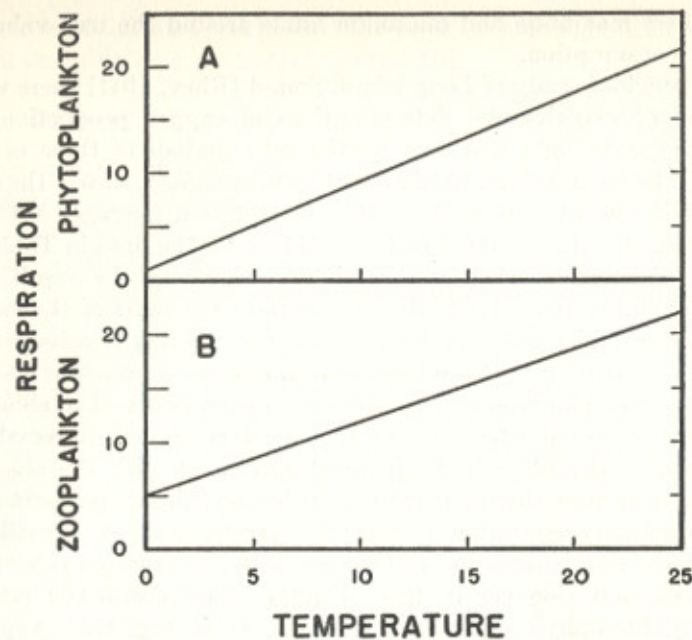

Figure 1. A. Coefficients of phytoplankton respiration. Daily oxygen consumption in microliters per microgram of chlorophyll. B. Zooplankton respiratory coefficients. Microliters of oxygen per day consumed by one milligram (wet weight) or one milliliter (displacement volume) of zooplankton.

fraction suitable for preserving the postulated annual mean. Numerical results will be presented later, but there are other problems to be discussed before the final summary is made.

In dealing with the 17.5 - 20 m stratum, an allowance will be made for respiration in the water, as in the rest of the vertical column. It will be assumed also that no photosynthesis occurs within this stratum. The difference between the net change for the whole stratum and the allowance for respiration in the water will then be allocated to bottom organisms.

Any treatment more detailed than a simple annual mean will also require further assumptions about net oxygen changes in the 0 - 2.5 m stratum: (a) The mean annual net changes are fixed at 0.27 ml O_2 /l/day for the first year and 0.31 ml for the second, as previously estimated. Adding 0.11 ml for respiration, the figures for total photosynthesis are respectively 0.38 and 0.42 ml/l. (b) Assuming that

seasonal variations observed in experimental bottles are applicable to the problem, the latter (cf. Table IV) are systematically raised to adjust the annual means to the figures quoted in (a) above. Gaps in the first year's data are filled in with figures from the second year.

Results are shown in the first column of Table V. The remainder of this table is derived simply by adding the estimated respiration to the net change in oxygen, as given in Table III.

A balance sheet of production and consumption is presented in Table VI. The photosynthesis column is derived from Table V, and the method of estimating phytoplankton respiration has been

TABLE V. ESTIMATED DAILY PHOTOSYNTHESIS IN ml O_2 /l, TABULATED AS AVERAGES FOR THE DEPTH RANGES LISTED

	0-2.5	2.5-7.5	7.5-12.5	12.5-17.5
1952-3				
Mar. 5-May 21	.64	.09	.05	.03
May 21-Aug. 19	.40	.23	.25	.12
Aug. 19-Nov. 17	.32	.17	.15	.09
Nov. 17-Feb. 10	.13	.04	.00	.00
Feb. 10-Mar. 16	.51	.18	.10	.08
1953-4				
Mar. 16-May 18	.72	.09	.08	.01
May 18-Aug. 25	.45	.24	.12	.12
Aug. 25-Nov. 18	.36	.14	.06	.06
Nov. 18-Jan. 25	.15	.04	.00	.00
Jan. 25-Feb. 24	.46	.18	.04	.00
Means				
1952-3	.38	.14	.12	.06
1953-4	.42	.14	.07	.05
1952-4	.40	.14	.09	.06

explained. The difference between the two, listed as net production, represents material that is available for the production of phytoplankton cells and eventual nourishment of the animal population and bacteria. Zooplankton respiration is derived with reference to Fig. 1B, which is based on respiratory data for *Acartia* spp., the dominant copepods in the Sound (see R. J. Conover in this volume). Average zooplankton volumes (No. 10 net) and mean temperatures for each period are applied to the figure to obtain the respiratory estimates listed. The method of estimating the oxygen consumption by bottom fauna and flora has been explained. The difference between total oxygen consumption and the combined phytoplankton, zooplankton, and benthic fractions is listed in the table as "other" respiration. Nominally this category is assigned to bacteria and to small zooplank-

TABLE VI. BALANCE SHEET OF OXYGEN PRODUCED AND CONSUMED IN ml O₂/day IN A COLUMN OF WATER ONE SQUARE CENTIMETER IN CROSS SECTION AND EXTENDING FROM THE SEA SURFACE TO THE BOTTOM, AT A DEPTH OF 20 m (THUS TOTALLING TWO LITERS OF WATER)

	Photo-synthesis	Net Production	Consumption				Total
			Water Column			on Bottom	
			Phyt.	Zoopl.	Other		
1952-3							
Mar. 5-May 21	.246	.152	.094	.030	-.012	.026	.138
May 21-Aug. 19	.402	.172	.230	.052	.072	.088	.442
Aug. 19-Nov. 17	.283	.123	.160	.060	.070	.046	.336
Nov. 17-Feb. 10	.052	-.008	.060	.004	.048	.017	.129
Feb. 10-Mar. 16	.310	.190	.120	.018	-.034	.015	.119
1953-4							
Mar. 16-May 18	.266	.170	.096	.022	-.006	.040	.152
May 18-Aug. 25	.352	.132	.220	.022	.112	.027	.381
Aug. 25-Nov. 18	.223	.037	.186	.028	.026	.020	.260
Nov. 18-Jan. 25	.057	.029	.028	.004	.080	.014	.126
Jan. 25-Feb. 24	.230	.142	.088	.018	-.002	.011	.115
Means							
1952-3	.254	.117	.137	.036	.039	.042	.254
1953-4	.236	.096	.140	.020	.052	.024	.236
1952-4	.245	.107	.138	.028	.046	.033	.245

ton that escape the No. 10 net, but not without reservations. Discussion of this matter is relegated to a later section of this paper.

PHOSPHATE UTILIZATION AND REGENERATION

The calculation of net changes in phosphate was simple and straightforward compared with the oxygen analysis, but conversion to estimates of total utilization and regeneration requires further discussion and additional arbitrary assumptions. Phosphate regeneration differs from oxygen consumption in that it is primarily associated with animal and bacterial metabolism. There is little reason to believe that phytoplankton respiration is accompanied by significant amounts of phosphorus excretion except under relatively abnormal conditions. Examination of the tabular material indicates that phosphorus utilization is more nearly uniform with respect to depth than oxygen production and that considerable utilization occurs at depths where phytoplankton respiration exceeds oxygen production. Thus the net change in phosphate in deep water is even less reliable than oxygen as an indicator of the magnitude of katabolic processes.

There are no experimental data that can be used to set an accurate value for phosphorus regeneration. Nor is there a precise relation between oxygen consumption and phosphorus regeneration. The

normal O:P ratio by atoms appears to be between 250:1 and 300:1, but extreme variations have been noted (Riley, 1951). It will be assumed here that there is an atomic ratio of 300:1 between oxygen consumption, exclusive of phytoplankton respiration, and phosphorus regeneration. This is sufficient to equal four of the positive net changes in Table I. It slightly exceeds four others and is exceeded by only one. The estimate therefore appears to be of the right order of magnitude.

TABLE VII. ESTIMATED DAILY UTILIZATION AND REGENERATION OF PHOSPHATE IN $\mu\text{g-AT P/CM}^2$ OF SEA SURFACE

	Utilization					Regeneration		
	0-2.5	2.5-7.5	7.5-12.5	12.5-17.5	Total	0-20	Bottom	Total
1952-3								
Mar. 5-May 21	.001	.014	.010	.002	.027	.005	.008	.013
May 21-Aug. 19	.010	.015	.021	.000	.046	.036	.029	.065
Aug. 19-Nov. 17	.011	.013	.009	.005	.038	.038	.023	.061
Nov. 17-Feb. 10	.010	.003	.000	.000	.013	.015	-.002	.013
Feb. 10-Mar. 16	.008	.057	.023	.026	.114	.000	.002	.002
1953-4								
Mar. 16-May 18	.013	.005	-.001	.004	.021	.005	.015	.020
May 18-Aug. 25	.012	.014	.005	.012	.043	.040	.021	.061
Aug. 25-Nov. 18	.010	.006	.004	.000	.020	.016	.026	.042
Nov. 18-Jan. 25	.011	.005	.002	.002	.020	.025	-.003	.022
Jan. 25-Feb. 24	.006	.051	.020	.008	.085	.005	-.001	.004
Means								
1952-3	.0082	.0154	.0113	.0040	.0389	.0221	.0138	.0360
1953-4	.0110	.0119	.0044	.0053	.0324	.0217	.0145	.0362
1952-4	.0095	.0137	.0080	.0046	.0358	.0219	.0141	.0361
Mean O:P ratio (atoms)								
	760	230	185	-104	262		205	

Results of the calculation are shown in Table VII. The last line shows O:P ratios for the two-year period. The over-all ratio for production is normal. Values for individual depth ranges are aberrant, indicating a marked lag between net phytoplankton production and phosphate absorption.

DISCUSSION

In a previous study of Long Island Sound (Riley, 1941), experimental determinations of oxygen production at the surface were approximately the same as those in the present survey. On the basis of transparency data then available, it was estimated that the total photosynthetic production of carbon might be 10 to 15 times

the surface value, or some 600 to 1000 g C/m² in a year's time. That conclusion has not been borne out by the present work. The mean annual production for the two-year period just completed is estimated to be only 470 g C/m². Over half of this production appears to be utilized in phytoplankton respiration. Of the estimated 205 g C/m² available to the rest of the biological association, 69% appears to be used by pelagic organisms, the remainder by the benthic population. The phosphate analysis gives a slightly different pattern of utilization—61% by pelagic fauna and flora and 39% on the bottom.

The two physical oceanographic analyses and the experimental measurements that have been used in deriving these estimates exhibit a considerable degree of internal consistency. On the other hand, the methods have been indirect and involved, containing a number of assumptions that probably are not altogether valid. One major possibility of error lies in an assumption about the nature of turbulence. If coefficients of eddy conductivity are larger than eddy diffusivity, as some have claimed, then the biological rates of change are over-estimated, particularly in spring and summer when maximum stability exists.

There also remains the question as to whether or not a reasonable set of assumptions has been made about the respiration of the plankton association. In carrying out the assumptions as stated, the final result was a production of about 88 g C/m² in excess of the demonstrable needs of the phytoplankton and No. 10 zooplankton catches. This excess was allocated in Table VI to "other" respiration in the water column, namely bacteria and microzooplankton. The observed numbers of tintinnids, early nauplii, etc., leave no doubt that this is a significant category. Nor is bacterial respiration likely to be negligible. Nevertheless, from the nature of the assumptions, it is possible that part of the 88 g of carbon constitutes error in the black bottle experiments.

Various aspects of the seasonal cycles and annual fluctuations warrant further attention. The spring flowering did not exhibit the excessive dominance over the rest of the seasonal cycle that is observed in some other waters. The rate of net oxygen production was more or less the same as the rest of the spring and summer season and constituted only 10 to 15% of the total annual production. The rate of phosphate utilization was approximately twice the highest value obtained at any other time in the year. However, the O:P

ratio was abnormally low, averaging about 150:1 for the total population, and this suggests that the phytoplankton was absorbing phosphate in excess of immediate needs, as it is known to do when the supply is abundant (Goldberg, *et al.*, 1951).

The calculated carbon production during the spring flowering exceeded demonstrable respiratory needs of the population by 34 g/m² in 1953 and 18 g in 1954. The state of anabolic dominance continued through the spring months until, by mid-May, nearly a third of the year's net carbon production existed in an unutilized state in the water column and on the bottom. It was then gradually used up during the remainder of the year, so that katabolic processes were dominant from mid-May until the onset of the next spring flowering. The same situation was found even more strikingly in the phosphate analysis (Table II), where the spring excess of utilization over regeneration was nearly 50% of the estimated net yearly utilization. Evidence of the same phenomenon in slightly varying form has been found in studies of the phosphorus cycle in the Gulf of Maine (Redfield, *et al.*, 1937) and in the English Channel (Armstrong and Harvey, 1950). There is no reason to regard it as abnormal, although the phenomenon may be exaggerated in shallow waters.

The spring zooplankton population did not expand in Long Island Sound as rapidly as it did in the English Channel and in some other areas that have been examined. The evidence pointed toward consumption of little more than a tenth of the flowering, which then terminated by rapid settling to the bottom. The reason for the failure of the zooplankton remains obscure. The obvious result was a summer and early autumn utilization of organic matter some 35% greater than the amount provided by current production. Such a system tends to smooth the adverse effects of fluctuations in available food. However, the long lag between production and utilization seems relatively inefficient from the standpoint of maximum use of the reservoir of nutrient elements.

Examination of the estimates of net oxygen production and phosphate utilization in Table VI and VII indicates that the spring flowering in 1953 was considerably more productive than that in 1954. This is not surprising, since cell counts and chlorophyll concentrations were also much larger. Of more ecological interest is the indication that the summer of 1952 was about 20 to 30% more productive than

the corresponding period in 1953. There was essentially no difference in the total standing crop of phytoplankton as indicated by chlorophyll concentrations. However, there were more diatoms and dinoflagellates in 1952 and possibly less naked flagellates and other forms not ordinarily included in cell counts. The one striking difference between the two summers was that the 1952 zooplankton volume averaged about two and a half times as much as the 1953 crop. Furthermore, the difference in net production between the two years approximately equalled the difference in the estimated food requirements of the zooplankton populations. In other words, the 1952 zooplankton increased sufficiently to use the extra production and keep the phytoplankton crop at the same general level.

The dominant species in the summer zooplankton population was *Acartia tonsa*. It is pointed out (see R. J. Conover in this volume) that this species appears to be particularly well adapted to feed on the larger phytoplankton forms and that both species of *Acartia* fed more effectively on diatoms than on natural populations of small summer flagellates. Thus the experimental work indicates that the species composition of the phytoplankton in 1952 was particularly favorable for the support of the larger members of the zooplankton population. It appears to be this, rather than the slight difference in productivity, that was primarily responsible for the vast difference in zooplankton crops.

In the waters of Block Island Sound, a relatively open body of coastal water east of Long Island Sound, a cursory one-year survey (Riley, 1952) has provided enough data for a rough comparison of the two areas. The ratio of annual mean surface phytoplankton concentration was 2.3:1, the larger value being in central Long Island Sound. The ratio of total crops was 1.5:1. Zooplankton displacement volumes (No. 10 net) were 1.5:1 on a volumetric basis and 1:1 in terms of quantity per unit area. With regard to oxygen production and consumption, the net utilization in the lower half of the water column in Block Island Sound totalled 41 ml/cm² in a year's time as compared with 36 ml in Long Island Sound. The net increase in oxygen at the surface appeared to be much larger in Block Island Sound (68 ml/year), and it was postulated that the excess of phytoplankton production over utilization was dissipated offshore by lateral diffusion. The total productivity of Block Island Sound was not determined. The correction factor for the respiration of

the plankton population is presumably smaller, and tentative estimates suggest that there is little difference in the total productivity of the two areas.

The extensive study by Harvey (1950) of production in the English Channel provides material for comparison of two quite different temperate water habitats. The area examined off Plymouth is deeper than Long Island Sound, averaging some 70 m. The nutrient and plankton concentrations are comparatively small, but it appears to be a remarkably efficient system with respect to both nutrient utilization and subsequent biological conversion.

TABLE VIII. COMPARISON OF MEAN ANNUAL STANDING CROPS AND ORGANIC PRODUCTION (g organic matter/m²) IN THE ENGLISH CHANNEL (EC) AND CENTRAL LONG ISLAND SOUND (LIS).

	Standing Crop		Daily Production		Respiratory Loss	
	EC	LIS	EC	LIS	EC	LIS
Phytoplankton	4	16	—	3.2*	—	1.8*
Zooplankton	1.5	2	.4-.5†	1.07†	.06	.28
Pelagic fish	1.8	—	.0016	—	.025	—
Bacteria	.04	—	—	—	.013	.46‡
Demersal fish	1-1.25	—	.001	—	.015	.33
Epl- and in-fauna	17	9	.03	—	.2-.3	
Bacteria	.1	—	—	—	.03	
Total, exclusive of phytoplankton respiration					.34-.44	1.07

* Photosynthetic glucose production and loss of glucose by respiration.

† Phytoplankton production in excess of respiratory requirement.

‡ In LIS this item also includes small zooplankton not sampled by the net.

Table VIII quotes part of the data from Harvey (1950: table 4) and compares it with the two-year averages from Long Island Sound. The method of arriving at the figures for Long Island Sound requires a few words of explanation. The mean standing crop of phytoplankton has a chlorophyll content of 6 µg/l. The chlorophyll content varies between 0.6 and 1.5% of the organic matter in surface net phytoplankton tows (see Harris and Riley in this volume), the latter figure applying primarily to a short period in winter and early spring. A reasonable average for the year is about 0.75%. Hence the standing crop of organic matter in a column of water 20 m deep appears to be about 16 g/m². However, Harvey used a conversion factor only half as large. If one or the other is in error, the ratio of abundance in the two areas might be only 2:1 instead of 4:1.

In the case of zooplankton, the organic content has averaged about 10% of the wet weight. This figure is applied to the mean annual

displacement volumes of No. 10 tows. Data on bottom fauna (see Sanders, in this volume) are measured dry weights less the weight of shells and other obviously nonorganic materials. A precise estimate of the quantity is not possible at this stage of the investigation, and the total population may be under-rated. There is an abundance of nematodes and other microfauna that has not been included in the measurements, and some of the largest animals have not been sampled adequately. Harvey's estimate may be a little large, since the recent survey by Holme (1953) gave an average value of 11.2 g dry weight/m².

Total photosynthesis and phytoplankton respiration are listed as glucose equivalents of oxygen data in Table VI. With regard to other data on production and respiration, one milliliter of oxygen is approximately equivalent to one milligram of organic matter of average carbon content. Therefore, the data in Table VI require no change except in the position of the decimal point. The figures for total oxygen consumption on the bottom in Long Island Sound properly include all three of Harvey's categories of bottom organisms. The pelagic fish constitute a blind spot in the Long Island Sound balance sheet. No allowance has been made for them in calculating total oxygen consumption, and if they utilize a significant amount of organic matter, the estimates of total production will need to be increased a corresponding amount.

These two bodies of water are not very different with respect to potential nutrient supply if the latter is rated in terms of the amount of essential elements underlying a unit area of surface at the time of the winter maximum. Long Island Sound has more phosphate and slightly less nitrate. In terms of nutrient concentrations, which are important in determining the rate of absorption, the Sound is superior. This, together with the efficiency of recirculation of regenerated nutrients in shallow turbulent waters, is presumably responsible for the high net production in the Sound.

The dominant members of the zooplankton population have been shown (R. J. Conover in this volume) to be relatively inefficient feeders with high respiratory requirements, and their inefficiency is reflected in a standing crop only slightly larger than the English Channel population, despite the large concentration of phytoplankton that is available. The latter appears to be mainly utilized by small organisms in the water column and by the benthic population. The benthic productivity is large, and the number of organisms is enormous,

since the fauna consists primarily of small herbivores and detritus feeders. Pelagic fish eggs and larvae are abundant (see Wheatland in this volume). The Sound may be an important spawning and nursery ground, but commercial fishery statistics indicate that the adult population is smaller than that in the open coastal waters to the east. In general, Long Island Sound appears to be relatively inefficient in the production of both groundfish and carnivorous invertebrate epifauna, as compared with both Block Island Sound and the English Channel.

The reasons for this inefficiency are not clear, although some of the symptoms are obvious: in spring an excessive plant growth that cannot be used immediately by the animal population and that probably is largely wasted in bacterial activity; in summer a heavy growth of small algae that appear not to provide adequate food for a mature zooplankton population. Possibly the Sound represents an intermediate point between a normal marine environment and the highly aberrant situation described by Ryther (1954) in Moriches Bay and Great South Bay, Long Island. There, excessive fertilization and reduced salinity promoted the growth of "small forms" which not only out-competed the larger phytoplankton species but also were useless or harmful to the animal population.

REFERENCES

- ARMSTRONG, F. A. J. AND H. W. HARVEY
1950. The cycle of phosphorus in the waters of the English Channel. *J. Mar. biol. Ass. U. K.*, (NS) 29: 145-162.
- GOLDBERG, E. D., T. J. WALKER, AND ALICE WHISENAND
1951. Phosphate utilization by diatoms. *Biol. Bull. Woods Hole*, 101: 274-284.
- HARVEY, H. W.
1950. On the production of living matter in the sea off Plymouth. *J. Mar. biol. Ass. U. K.*, (NS) 29: 97-137.
- HOLME, N. A.
1953. The biomass of the bottom fauna in the English Channel off Plymouth. *J. Mar. biol. Ass. U. K.*, (NS) 32: 1-49.
- REDFIELD, A. C., H. P. SMITH, AND B. H. KETCHUM
1937. The cycle of organic phosphorus in the Gulf of Maine. *Biol. Bull. Woods Hole*, 73: 421-443.

RILEY, G. A.

1941. Plankton studies. III. Long Island Sound. Bull. Bingham oceanogr. Coll., 7 (3): 1-93.

1951. Oxygen, phosphate, and nitrate in the Atlantic Ocean. Bull. Bingham oceanogr. Coll., 13 (1): 1-126.

1952. Phytoplankton of Block Island Sound, 1949. Bull. Bingham oceanogr. Coll. 13 (3): 40-64.

RILEY, G. A., HENRY STOMMEL, AND D. F. BUMPUS

1949. Quantitative ecology of the western North Atlantic. Bull. Bingham oceanogr. Coll., 12 (3): 1-169.

RYTHER, J. H.

1954. The ecology of phytoplankton blooms in Moriches Bay and Great South Bay, Long Island, New York. Biol. Bull. Woods Hole, 106: 198-209.

OCEANOGRAPHY OF LONG ISLAND SOUND,
1952-1954

X. THE BIOLOGY OF MARINE BOTTOM COMMUNITIES

BY

HOWARD L. SANDERS*

Bingham Oceanographic Laboratory

TABLE OF CONTENTS

ABSTRACT.....	346
ACKNOWLEDGMENTS.....	347
INTRODUCTION.....	347
METHODS.....	348
<i>Equipment</i>	350
<i>Treatment of Samples</i>	350
<i>Mechanical Analysis</i>	350
QUANTITATIVE EVALUATION OF BENTHIC ANIMALS.....	357
<i>Results in Long Island Sound</i>	357
Charles Island.....	359
Station 1.....	359
Station 2.....	359
Station 3.....	360
Station 4.....	360
Station 5.....	360
Station 7.....	360
Station 8.....	360
<i>Comparison with Other Areas</i>	363
<i>Environmental and Biological Conditions</i>	367
LIFE HISTORIES.....	369
<i>Nephtys incisa</i>	369
<i>Cistenoides gouldii</i>	372
The <i>Ampelisca</i> Complex.....	374
<i>Yoldia limatula</i>	380
<i>Nucula proxima</i>	383

* Present address: Woods Hole Oceanographic Institution, Woods Hole, Massachusetts.

<i>Pandora gouldiana</i>	384
<i>Macoma tenta</i>	387
<i>Lyonsia hyalina</i>	388
<i>Mulinia lateralis</i>	388
PRODUCTIVITY.....	390
THE COMMUNITY.....	395
<i>Level-Bottom Communities of Long Island Sound</i>	395
<i>The Relationship of Primary Feeding Types to Sediment Composition</i>	399
SUMMARY AND CONCLUSIONS.....	403
REFERENCES.....	406
APPENDIX I.....	410
APPENDIX II.....	412
APPENDIX III.....	413

ABSTRACT

The results of a bottom survey carried out from August 1953 to September 1954 revealed that Long Island Sound, in contrast to other areas, supports extremely large populations of benthic animals. The mean number at each station varied from 5,563 to 46,398, while the mean weight of animals less than 0.2 g dry weight ranged from 4.54 to 36.38 g/m². The infauna of each station was characterized by a narrow range of biomass values which were largely dependent on sediment composition. The greatest biomasses were found when the sediment contained from 13-25% silt and clay. This appeared to be an optimal concentration, since both increases and decreases of the silt-clay fraction gave progressively smaller biomass values.

The biology of some of the dominant animals is discussed. The genus *Ampelisca* was particularly interesting in that it could be divided into two distinct groups with respect to size and distribution although the groups could not be separated on the basis of taxonomic characters. Form A was confined to coarser sediments and was 3-4 times as heavy as its counterpart, form B, which was found only in the softer sediments. In both species the females appeared to be about 15 times more abundant than the males. However, on closer examination, it was apparent that approximately half of the females were gynomorphic males.

Values for organic production were obtained for four of the dominant species. On the basis of these figures, the annual productivity (2.44 times larger than that of the mean standing crop) was determined for the infauna.

The relationship between primary feeding types and sediment composition was investigated. Suspension feeders were clearly the major feeding types in coarser sediments, while selective and nonselective deposit feeders dominated the finer sediments.

A new association of animals, the *Nephtys incisa-Yoldia limatula* community is described. This soft bottom community is limited to sediments containing more than 25% silt-clay and is found at depths of from 4 to at least 30 m.

ACKNOWLEDGMENTS

G. A. Riley, E. F. Thompson and G. E. Hutchinson gave considerable advice on many matters relating to this study. The analyses of the sediment were carried out with the facilities of the Soil Department of the Connecticut Agricultural Experiment Station, where T. Tamura generously gave his time and supervision in this aspect of the work. Miss Olga Hartman, P. A. Morris and Willard Hartman identified or verified the identity of certain specimens. The field work was done aboard the U. S. Fish and Wildlife Vessel SHANG WHEELER with the assistance of its skipper, H. R. Glas. The facilities of the U. S. Fish and Wildlife station at Milford, Connecticut were always available and the staff, particularly the director, Victor Loosanoff, was helpful in many ways. The manuscript, read by G. A. Riley, E. F. Thompson, Daniel Merriman and G. E. Hutchinson was greatly improved by their constructive suggestions. Finally, my wife, Lillian Sanders, undertook the tedious tasks of preparing the illustrations and of typing and retyping the manuscript. To all of these persons, individually and collectively, I am indebted.

INTRODUCTION

Since 1911 numerous quantitative bottom investigations have been undertaken in many parts of the world, particularly in northwestern Europe. However, with the exception of a single modest study in the Cape Cod region of Massachusetts (Lee, 1944), no quantitative survey of bottom communities from any region of the eastern coast of North America has been published. The present investigation, within the limited area of Long Island Sound, was undertaken in an attempt to correct this condition.

This study represents a single component of a comprehensive oceanographic and biological survey of Long Island Sound carried out by members of the Bingham Oceanographic Laboratory of Yale University. Aspects that will be considered in this paper are: (1) species composition of the benthic populations; (2) quantitative evaluation of benthic animals; (3) relation of biomass to physical factors, such as sediment composition; (4) the effect of certain physical factors on the distribution of the primary feeding types of benthic animals; (5) comparison of biomass and numerical values in Long Island Sound with those found in other regions; (6) life histories of

the more important dominant species; (7) productivity and the standing crop; and (8) a description of the benthic communities of Long Island Sound.

METHODS

The central area of Long Island Sound (see Fig. 1) was investigated for a period extending from the summer of 1953 until the fall of 1954. Collections were made aboard the U. S. Fish and Wildlife Vessel, SHANG WHEELER, stationed at Milford, Connecticut. Eight stations were set up as shown in Table I.

TABLE I. LIST OF STATIONS

Station	Latitude, N	Longitude, W	Depth (m)	Bottom Temperature °C		Bottom Salinity ‰	
				Max.	Min.	Max.	Min.
Charles Is.	41-11.3	73-06.4	6 - 8	*	*	*	*
1	41-11.1	73-01.8	10 -12	22.10	1.55	28.67	24.77
2	41-08.0	72-53.9	19 -22	21.95	1.85	28.73	24.84
3	41-06.3	73-00.2	27 -29	21.65	2.15	28.87	25.45
4	41-04.9	73-05.2	18.5-22.5	21.95	1.85	28.69	25.35
5	41-01.4	72-58.6	28.5-31	21.60	1.25	28.76	24.78
7	41-13.6	72-50.6	10 -13	22.00	0.80	28.96	24.70
8	41-14.6	72-46.4	11.5-14	22.05	1.35	29.18	25.02

* Not taken.

Charles Island and Sts. 1 and 3 were sampled every other month; Sts. 4, 5 and 7 every three months; Sts. 2 and 8 twice yearly.

In the present study, consideration of currents is particularly important from the standpoint of the food supply of suspension feeders. Strong currents have the double effect of rapidly renewing the water in the immediate vicinity of the bottom and of resuspending particles that have settled out while weak currents would be less effective in these respects. In addition, a weak flow permits an accumulation of silt and clay which forms a surface that tends to hamper resuspension of organic materials, as will be described later.

The general order of magnitude of maximum current speed at approximately one meter from the bottom was 20-35 cm/sec in the central area, and the average speed of the entire tidal cycle was about two-thirds of the maximum current speed (see Riley's *PHYSICAL OCEANOGRAPHY* in this volume). Since there are only minimal differences in the measured currents from one station to another, and since the current speeds decrease toward bottom, it is difficult to get an accurate measurement close enough to bottom to be useful for present purposes.

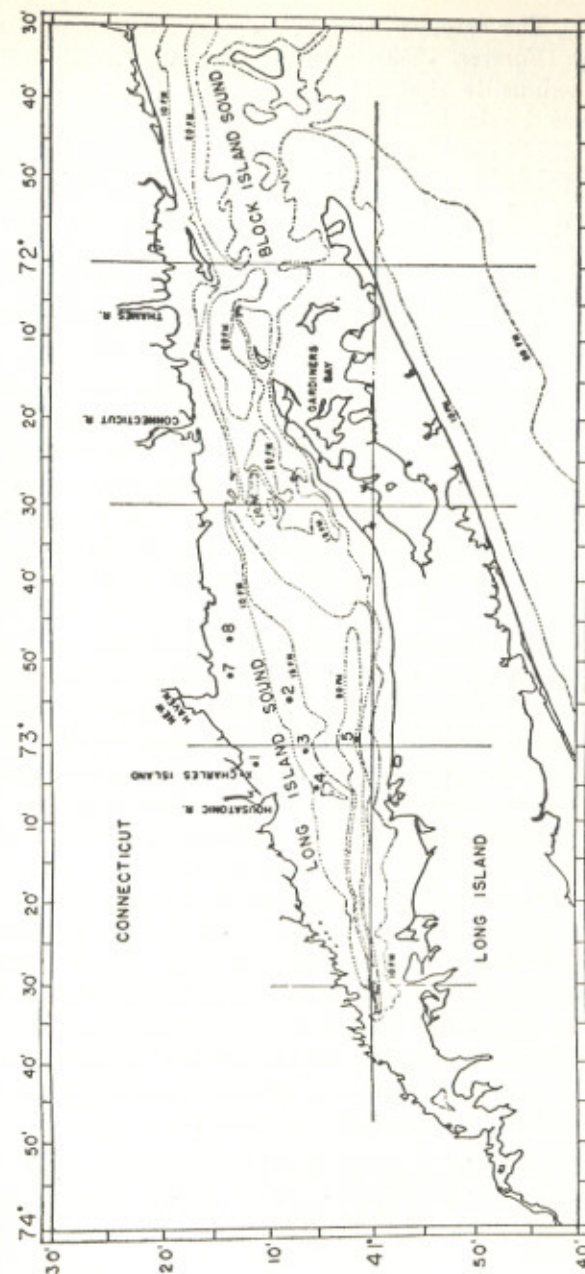

Figure 1. Map of Long Island Sound showing the location of the eight stations occupied in the survey.

Equipment. The samples were collected by means of a modified anchor dredge (Forster, 1953) which was designed to obtain samples from sandy sediments that are inadequately sampled by ordinary dredges. Since the dredge, loaded with sediment, was often damaged against the sides of the vessel in rough seas, it was necessary to build a protective frame around the instrument. To facilitate digging, bars of lead were placed within the frame, particularly over the digging edge, thus increasing the weight of the dredge from 25 to 85 pounds. The dredge cut to a depth of 7.6 cm in all types of sediments, and a small-meshed burlap bag attached to the frame caught and retained the sediment that passed into it.

Treatment of Samples. Each sediment sample was emptied into a large bucket where it was divided into three parts and then measured. Large fractions, such as those of about 13,000 cc, were washed through a No. 10 sieve; smaller fractions of about 1,500 cc were put through a No. 50 sieve to retain the smaller organisms. Since the gear dug to a depth of 7.6 cm, the area of the sample was obtained by dividing the volume by 7.6. About 500 cc were saved for mechanical analysis of the sediment.

The organisms in both large and small fractions were carefully picked out and sorted to species; each individual of a nondominant form was counted and weighed with other members of its species. Initial use of wet weight gave such unreliable data that the use of dry weight was adopted. Specimens were placed in an oven and heated at about 100° C to constant weight, after which they were weighed on a sensitive balance. The calcium carbonate of mollusc shells was removed by use of dilute hydrochloric acid.

For each of the numerically abundant (dominant) species, a series of graduated size ranges was obtained and individuals were stored in formalin according to their length category. When enough individuals of each size group had been accumulated, the total dry weight was obtained in the manner described above and this figure was divided by the number of animals used. In this manner an exact relationship between length and dry weight was obtained for the various sizes of each of the dominant species (see Appendix I).

Mechanical Analysis. One of the important factors in a study of benthic communities is the character of the bottom which the animals inhabit. Since particle size analysis has been extensively

studied by soil scientists, their standard procedures (Buoyoucos, 1936) were employed in this study. First the air-dried sediment was gently ground in a mortar equipped with a rubber tipped pestle and then sieved through a 2 mm round hole screen. The portion retained on the sieve was the gravel component. A portion of the residue, usually either 50 or 100 g, was placed in suspension in a mechanical agitator, and one cc of sodium oxylate and one cc of sodium hydroxide were added. Sodium oxylate is a dispersing agent in itself and sodium hydroxide has the effect of raising the pH and thus enhancing further the dispersing action. The solution, after agitation in a Waring blender for 5-10 minutes depending on the size of the sample, was placed in a Buoyoucos cylinder to which water was added to bring the water column to the desired level. The solution was again agitated for at least one minute by means of a manual agitator so as to force all of the material into suspension.

Different size particles settle out at different rates of speed, the larger the particle the more rapid the settling. In this procedure the changes in density of the medium at given intervals of time were measured and the percentages of the different size particles were determined. At the end of 40 seconds, when all sand-size particles had settled out, hydrometer and temperature readings were taken. Since temperature alters the density of the medium, it was corrected to 57° F; for every degree over 57° F, 0.2 was subtracted from the hydrometer reading, and for every degree under, 0.2 was added. Readings at the end of 15 minutes, one hour and two hours gave the concentrations by weight of coarse silt (50-20 μ), medium silt (20-5 μ), fine silt (5-2 μ) and clay (< 2 μ).

The sand fraction, which was retained and dried in an oven, was passed through a series of sieves having apertures of 1.0, 0.5, 0.25, 0.105 and 0.049 mm. The sand retained on each of these screens was weighed to obtain a measure of very coarse (1.0-2.0 mm), coarse (0.5-1.0 mm), medium (0.25-0.5 mm), fine (0.105-0.25 mm) and very fine (0.049-0.105 mm) sands.

During the preliminary dispersing treatment there was a great deal of flocculation of the finer particles due to excess salt in the marine sediments, hence it was necessary to modify the procedure. To remove this excess salt, the sample was centrifuged a number of times with distilled water and after each centrifugation the clear supernatant was decanted off. This procedure was continued until the solution

TABLE III.—Continued

Location and Date	Gravel ^ 2.0mm	Sand					Silt			Clay ^ 2μ	Type of Soil	Shell
		Very Coarse 1.0 < 2.0mm	Coarse 0.5 < 1.0mm	Medium .25 < 0.5mm	Fine .105 < 0.25mm	Very Fine .049 < .105mm	50-20μ	< 20-5μ	5-2μ			
Station 1—Continued												
8/20/54	14.56	79.887					2.392	0.769	0.256	2.136	Gravelly sand	5.65
		5Y-7/1-7/2 light gray										
Station 4												
8/23/53	9.70	10.183	25.607	28.700	17.962	0.986	1.535	0.181	1.174	3.973	Coarse sand	—
		2.5Y-5/2 gray brown										
5/20/54	27.89	5.375	17.924	10.280	32.640	0.911	0.793	0.433	0.288	3.461	Very gravelly coarse sand	0.28
		10YR-6/3-6/4 light yellowish brown										
7/2/54	12.82	16.308	30.040	17.946	17.332	0.322	1.221	1.133	0.262	2.615	Gravelly coarse sand	0.29
		2.5Y-6/2 light brown gray										
Station 5												
2/18/54	3.83	2.641	22.242	12.202	33.835	1.207	6.732	3.270	1.923	12.117	Coarse sandy loam to sandy loam	—
		5Y-6/1-6/2 light olive gray—gray										
5/20/54	0.33	1.170	27.833	26.895	35.537	0.159	1.595	0.797	1.196	4.485	Coarse sand	—
		2.5Y-6/2 light brown gray										
7/2/54	3.74	6.441	35.846	15.814	14.573	0.290	5.583	3.658	1.540	12.514	Coarse sandy loam	—
		5Y-6/1 gray										

TABLE III.—Continued

Location and Date	Gravel ^ 2.0mm	Sand					Silt			Clay ^ 2μ	Type of Soil	Shell
		Very Coarse 1.0 < 2.0mm	Coarse 0.5 < 1.0mm	Medium .25 < 0.5mm	Fine .105 < 0.25mm	Very Fine .049 < .105mm	50-20μ	< 20-5μ	5-2μ			
Station 2												
7/23/54	0.00	1.548	6.447	10.176	25.629	0.000	19.80	10.80	4.6	21.0	Loam	—
		43.800										
		5Y-7/1-7/2 light gray										
Station 7												
5/20/54	3.44	7.789	17.923	6.679	23.600	4.263	12.553	5.600	1.159	16.994	Coarse sandy loam to sandy loam	2.91
		60.254										
		5Y-7/1 (mainly) -8/1 light gray										
Station 8												
7/23/54	0.00	72.000					15.4	4.2	0.8	7.6	Coarse sandy loam	1.00
		5Y-6/2-7/2 light olive gray—light gray										
Station 3												
2/13/54	0.00	0.537	1.842	1.543	5.939	15.543	22.4	11.0	7.2	34.0	Silty clay loam	—
		25.404										
		5Y-7/1-7/2 light gray										
4/19/54	0.00	0.509	2.244	1.599	14.103	10.345	20.4	11.4	6.0	33.4	Silty clay loam	—
		28.800										
		5Y-6/1 gray										
6/29/54	0.00	0.00	0.00	1.339	10.238	13.023	9.8	13.4	6.4	45.8	Silty clay	—
		24.600										
		5Y-6/1-7/1 light gray—gray										
8/20/54	0.00	40.4					19.6	9.4	4.4	26.2	Loam to silty clay	—
		5Y-6/1 gray										

a significant fraction of shell was present it was placed in a separate column and its percentage computed.

It is somewhat difficult to compare the sediment analysis of this investigation with that of previous studies because of the variety of standards used. Beanland (1940) separated the particles into three grades: sand, with a minimum diameter of 0.04 mm; silts, with a minimum of 0.01 mm; and fine silts, with a minimum of 0.002 mm. The proportions of the three components in each sample were added and the mean-sized particle or "Representative Number" was determined. This was multiplied by a factor of 100 to give the whole number which was used to characterize the sample.

Fraser (1932), working in estuarine mud, divided his sediments into the following grades: (1) above 0.1 mm; (2) between 0.06 and 0.1 mm; (3) between 0.02-0.06 mm; (4) below 0.02 mm; and finally silt. Crawford (1937), using the procedure of Allen (1899), separated the sediment into eight grades: stones, coarse gravel, medium gravel, fine gravel, coarse sand, medium sand, fine sand, and silts; these were defined as materials which will not pass through sieves of 15, 5, 2.5, 1.5, 1.0, 0.5 mm, material which will pass through a 0.5 mm sieve but which settles out in one minute, and particles which remain in suspension at the end of one minute. Holme (1949, 1953) employed the Wentworth grade scale, using sieves of the following apertures: 2.0, 1.0, 0.5, 0.25, 0.20 and 0.125 mm; particle separation at 1/32 mm was made by repeated decantations. Aside from the large number of scales used, these works suffer from failure to separate the clay from the silt fraction.

Compared to the works referred to above, even the coarser sediments (see Sts. 1 and 4) in the present study yielded appreciable fractions of clay particles. Certain samples, primarily from St. 3, gave larger concentrations of clay than any of those obtained by the above investigators. Although these larger concentrations may reflect high concentrations of these particles in certain deposits in the Long Island Sound area, it is probable that they are due in large measure to the technique used. More accurate procedures for mechanical analysis with pipetting techniques are published by Soil Survey Staff (1951), but such techniques are much more time consuming than the Buoyocos hydrometer method unless a laboratory is specially equipped to do mechanical analysis. The values obtained for the silt-clay content by the Buoyocos method are

probably somewhat low. At any rate, the low values reported for these fractions in previous benthic studies lead one to suspect that the techniques used have involved serious losses of these components.

QUANTITATIVE EVALUATION OF BENTHIC ANIMALS

Results in Long Island Sound. In 36 samples, taken from August 1953 to September 1954, 135 animals were found, 119 of which were identified to species (see Appendix II). Included among these was *Hutchinsoniella macracantha*, which represents a new subclass of

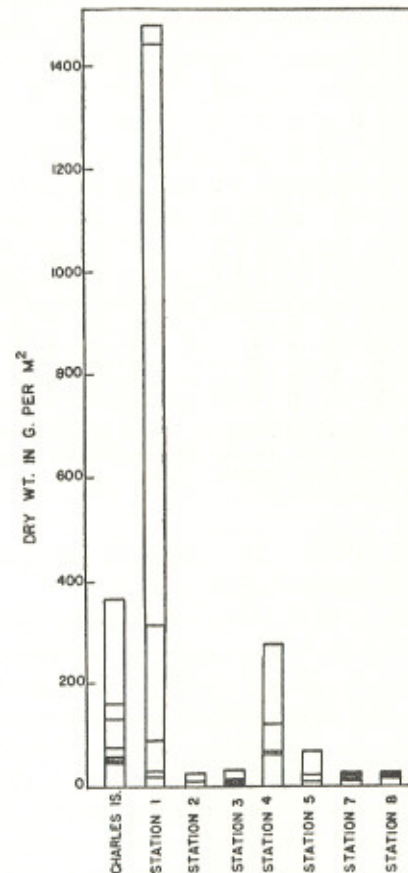

Figure 2. Total dry weight of each sample by station. The height of each horizontal line from the baseline represents the biomass of a single sample.

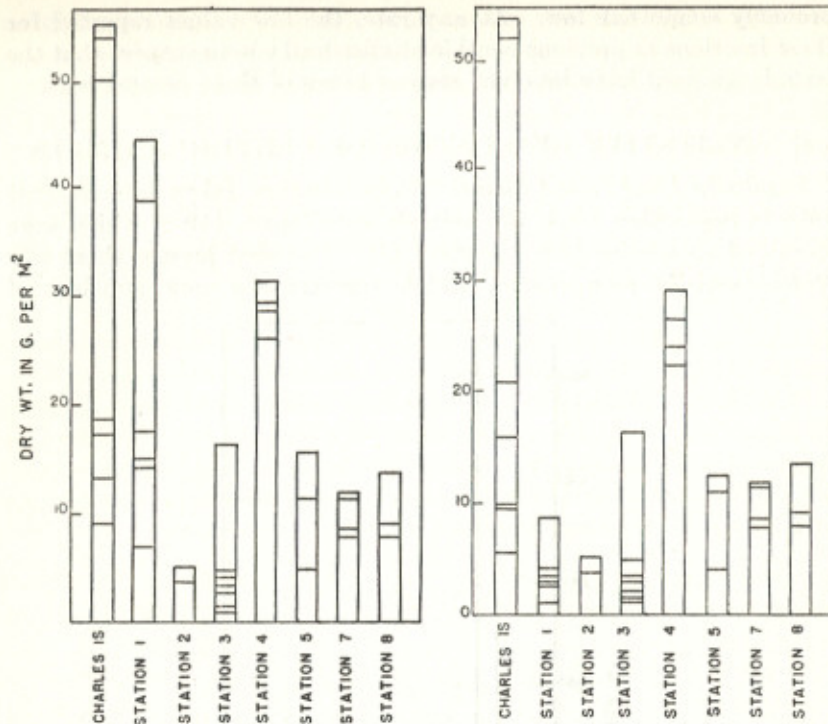

Figure 3. Dry weight of animals weighing less than 0.2 g in each sample by station. Height of each horizontal line from baseline represents the biomass of a single sample.

Figure 4. Dry weight of infauna weighing less than 0.2 g in each sample.

Crustacea (Sanders, 1955). The analyses of some representative stations are shown in Appendix III.¹

In this investigation, as in others of a similar nature, the biomass frequently varied widely from sample to sample and from station to station. For instance, Holme (1953) found great variance between successive hauls at the same location and between pairs of samples from the same haul. It is apparent in the total dry weights of all samples in the present study (see Fig. 2) that the biomass varied widely in different samples from the same station, particularly those from Charles Island and from Sts. 1 and 4. Such large differences have resulted primarily from the occasional random distribution

¹ Complete data may be obtained from the Bingham Oceanographic Laboratory.

of certain large epifaunal animals such as *Libinia emarginata*, *Cancer irrorata*, *Ovalipes ocellatus*, *Pagurus pollicaris*, and *Asterias forbesi* whose size was sufficient to increase the weight of a sample anywhere from 200–5,000%. However, as shown in Fig. 3, if the large organisms are excluded and if only those individuals which weigh 0.2 g (dry weight) or less are included, then a greater degree of uniformity and a more workable correlation of biomass to its environment are achieved. Hereafter animals within this weight range will be referred to as "small animals." An even better homogeneity is achieved when only small animals of the infauna are considered (see Fig. 4). The infauna is defined in the manner of Petersen (1913) as "animals connected with the level sea bottom," these being forms that burrow or live in the sediment. The epifauna, on the other hand, consists of those forms which are found on the sea bottom and which may be sessile attached or motile. When only small animals of the infauna are considered, each station can be characterized by a relatively narrow range of biomass values.

Charles Island. Excluding two aberrant samples, this station supports an infauna of 5.70–20.90g/m² and its sediments contain less than 6% gravel, about 89% sands, 3.5% silts, and 4% clay. The predominant sand grain, making up 37–50% of the entire sediment by weight, is fine (0.25–0.105 mm). Shell, if included in the analysis, would comprise 4%. The sample with the highest silt-clay content (April 30, 1954) had the heaviest biomass, 20.90g/m².

The two samples excluded from the above discussion (August 17, 1953; October 28, 1953) differed from the others in that their silt-clay content was approximately 20% greater; their recorded biomass was 53.0 g/m². These data suggest a positive correlation between silt-clay content and biomass values at Charles Island.

Station 1. The infaunal contribution to the biomass, 1.14–8.74 g/m², with the mode about 3.40 g, was small in that it was only one-fifth as large as the small animals in the epifauna (see Figs. 3, 5). The sediments at this station, which were very coarse, consisted of: gravel, 15–36%; sands, 60–76%; silts, about 2.5%; and clays 2.2%. A significant fraction of shell, largely from the oyster *Crassostrea virginica*, was present also: 6–17%.

Station 2. The sediment was characterized by a high fraction of silt and clay, the silts averaging 35%, the clays 21%. Sands

constituted the remaining 44%; gravel and shell were absent. The biomass of the infauna varied from 3.80–5.70 g while the epifauna contributed almost nothing to the standing crop.

Station 3. Here was found not only the highest silt-clay percentage of any station in the survey but also the lowest values for total biomass and infauna; almost no epifauna was present. Six of the seven infaunal values varied from 1.14–4.94 g/m², and the seventh (Aug. 11, 1953), 16.49 g, was made up largely of a single species, *Nucula proxima*, which comprised more than 80% of the biomass. The sediment consisted of the following: sands, predominantly the finer grades, 24–30% by weight; gravels and shells, 0; silts, 28–40%; and clays, 26–45%. In contrast to the findings at Charles Island, the significantly larger silt-clay content at Sts. 2 and 3 is associated with low biomass values.

Station 4. Composition of the sediment at this station differed drastically from that at Sts. 2 and 3. Gravels made a major contribution with 9–28%; sands, 66–83%; silts, 1.5–2.9%; clays, 2.6–4.0%. Shell, if included, would have comprised only a fraction of one percent of the sample. When the largest animals were excluded, the infauna component was by far the most important part of the biomass, yielding relatively high values: 22.42–29.26 g/m².

Station 5. Here two different types of sediments were found. Two of the three samples were composed of 3.8% gravel, 72–73% sand, 10.5–12% silt, and 12–12.5% clay; the biomass of the infauna was somewhat intermediate, with values varying from 11.02–12.54 g/m². The third sample (May 20, 1954) contained a much higher fraction of sand, 91.6%, while gravel, silts, and clays comprised only 0.3, 3.6 and 4.5% respectively. The biomass value was low, 4.03 g, or about one-third of the standing crop found in the other two samples.

Station 7. Again the population was largely represented by infauna, the biomass values being intermediate, from 7.60 to 12.16 g/m². The gravels, sands, silts and clays constituted approximately 3.5, 60.0, 19.5 and 12.0% respectively. Shell comprised less than 3% of the sample.

Station 8. This station was also characterized by intermediate biomass values, 7.60–14.0 g/m². The sediments were made up of about 72% sands, 20.5% silts and 7.5% clays. Gravels were not present and shell made up only a minute fraction of the sample.

Although samples were taken at all seasons of the year, seasonal variations were not great enough to mask differences in biomass between stations. In fact, the biomass values were so distinctly different that it is reasonable to assume that the seasonal effect was of secondary importance. On those few occasions when one or two samples from a station departed widely from average values, it was found that such departures were associated with abnormal sediment composition (e.g., Charles Island and St. 5). Thus they represented different sediment environments rather than seasonal fluctuations.

The reason for the characteristic biomass values of each station is more difficult to explain. For example, why were the infauna of the two stations with the coarsest sediments so different? At St. 4, where no shells were present, the biomass was six times greater than that at St. 1, where shells were abundant. Since the shells at St. 1 were large and relatively flat (*Crassostrea virginica*) and since they were probably distributed for the most part on or near the surface, is it not feasible to assume that the infauna was unable to make contact with the surface sediment and was thereby excluded from the sediment when such shells were present. Thus we may postulate that the size of the infauna may be influenced in part at least by the extent to which the available bottom is covered by shells.

Also, from the data we find that there is a fairly definite relationship of infaunal values to the amount of silt and clay in the sediment. That is, assuming other factors equal, the infauna increases with increasing amounts of silt and clay up to a certain point and then decreases with further increase of silt and clay fractions. For example, at Charles Island and at St. 5, when the silt content was low, the infauna increased with increasing amounts of silt and clay. Sts. 2 and 3, with large silt-clay concentrations of 60–75%, yielded the smallest infaunal values. St. 7, with a silt-clay content of about 32%, gave appreciably higher values. It appears, then, that silt-clay concentrations which are too small or too large restrict or reduce the size of the biomass. Hence we postulate an optimal concentration of silts and clays for the development of maximal infaunal populations. The optimal range in this study is estimated to be 13–25% silt-clay, with deviations in either direction from these values yielding progressively smaller biomass values.

The mean dry weights of small infauna and epifauna at each station (Fig. 5) show that significant epifaunal values were found at stations

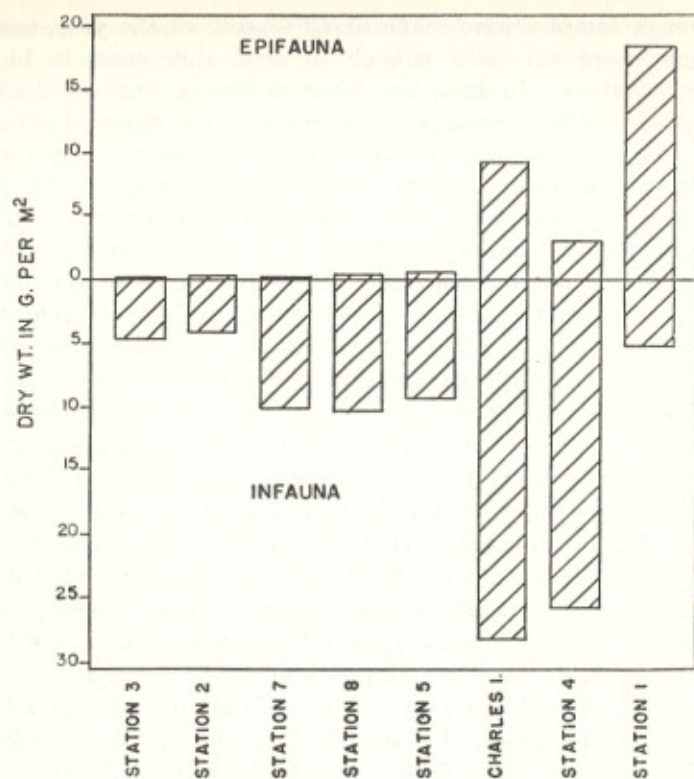

Figure 5. Mean dry weight of small infauna and epifauna at each station.

having hard sandy substrates, that is, Charles Island and Sts. 1 and 4. The remaining stations provided neither the stability nor solidity to develop such large populations.

Table IV gives the mean number of animals characteristic of each station. The large values for Charles Island, 46,398, were primarily due to high silt-clay concentrations in the two samples taken on August 17 and October 28, 1953: 173,120 and 98,507 animals/m² respectively.

Although the larger animals were numerically insignificant in comparison with the great numerical predominance of the smaller ones, they still made an important contribution to the standing crop. Table V gives the number and weight composition of the large animals for each station.

TABLE IV. MEAN NUMBER OF ANIMALS CHARACTERISTIC OF EACH STATION

Station	Animals (per m ²)
Charles Is.	46,398
4	34,762
8	15,200
7	8,421
1	7,957
2	7,395
3	5,844
5	5,563
	$\bar{M} = 16,443$

TABLE V. NUMBERS AND WEIGHTS OF ANIMALS WEIGHING MORE THAN 0.2 g DRY WEIGHT

Station	Number (%)	Weight (%)
Charles Is.	00.160	49.89
1	00.163	92.19
4	00.049	29.32
5	00.228	41.42
2	00.051	51.45
3	00.018	16.58
7	absent	absent
8	absent	absent
	$\bar{M} = 00.140$	$\bar{M} = 35.11$

Comparison with Other Areas. It is almost impossible to compare directly the results of this study with those of previous investigations because of the varied methods and equipment. Sometimes the animals were only weighed, other times only counted; at least nine different types of sampling gear have been used, and the sieve sizes used in screening out the organisms have been almost as varied as the gear; finally, calculation of animal weight has varied widely with each individual survey. However, in spite of the diverse nature of previous work, an attempt has been made to compare the numerical results of some of these investigations by plotting mesh size against the log of the number of animals per square meter (Fig. 6).

Even with sieves of 0.5 and 1.0 mm apertures, Miyadi (1940, 1941, 1941a) obtained extremely low values (266-1,290 animals/m²) from various Japanese bays, probably due to the small size of his bottom samples, 1/37m² with the Eckman grab and 1/50m² with the Eckman-Lenz grab.

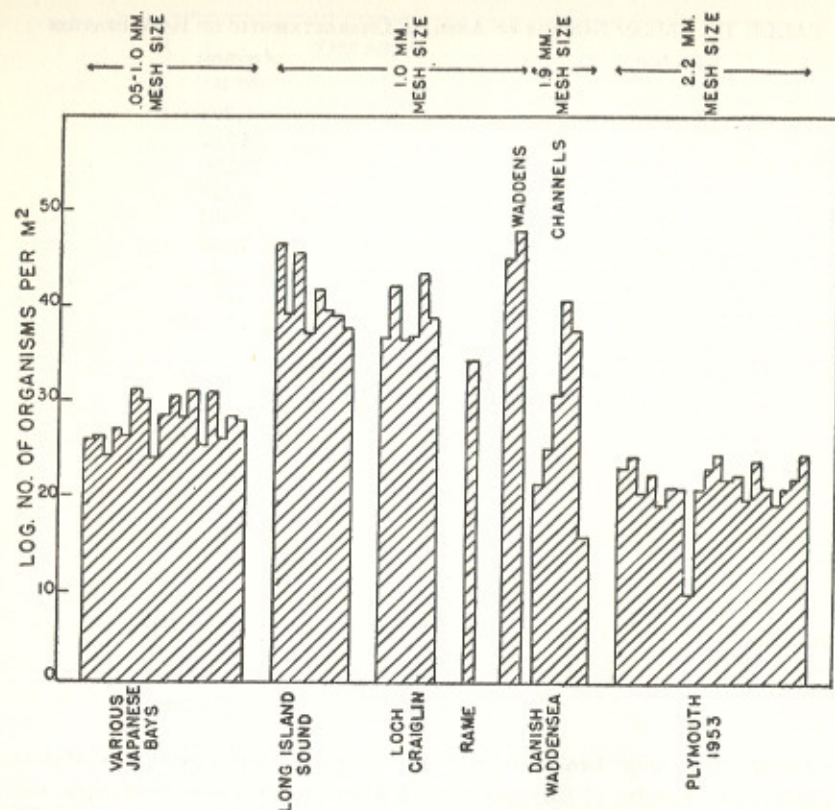

Figure 6. Numerical comparison of Long Island Sound with other regions. Each histogram consists of individual components that represent individual stations. For example, the Plymouth histogram represents 20 stations.

In other surveys, including the present study, sieves with 1 mm apertures were also used. Raymont (1949), in his studies of the effect of fertilizers on an enclosed Scottish loch, obtained values over a period of five years that varied from 4,554 to 23,014 animals/m²; however, if we exclude the two peaks which appear to result directly from addition of fertilizers, then the upper limit of the range would be 7,451 organisms/m². In a single sample of macrofauna, Mare (1942) obtained a numerical value of 2,356 animals/m² during her investigation of various trophic levels in a bottom community of the open shallow coast near Plymouth. In Long Island Sound the mean values for the eight stations varied from 5,566 at St. 5 to 46,404

animals/m² at Charles Island, with the average of the means being 16,446.

Although Smidt (1951) studied intertidal flats or "waddens" rather than permanently submerged areas, his investigation was the only one of those considered that showed populations which were as large or larger than those of the Sound (31,000/m² during July-August 1941 in the southern area; 63,600/m² at Skallingen, August 1942). Since most of his values consisted of 0-group or newly settled lamellibranchs, samplings at other times of the year, particularly during winter and spring, might reveal sharply reduced numbers. Smidt also took samples from the shallow channels in the waddens (2-8m), and in these permanently submerged areas he found greatly reduced numbers, about 40-11,100, with a mean value of 3,073 animals/m². Only a partial explanation for this wide difference in subtidal areas can be found in the fact that he used a screen with 1.9 mm mesh.

Holme (1953), in an extensive survey of the English Channel, sampled a grid of 20 stations and passed the sediment contents through a 2.2 mm sieve. The number of animals per sample ranged from 10-292, with a mean of 160/m². He then passed the residue from one of these samples through a 1.2 mm sieve; 28 animals were retained on the larger screen and 70 additional specimens were retained on the smaller screen. Although Holme's samples were taken close to the same general locality investigated by Mare, he found a whole order of magnitude less than that reported by Mare. The great discrepancy was probably due to sampling error, although differences in mesh size may have been a contributing factor.

From this brief listing of results, it is apparent that Long Island Sound, in contrast to other regions, supports significant numbers of benthic animals. Even when one considers the varying methods and techniques of other investigators it is probable that the number of animals in a unit area of bottom in Long Island Sound is as high as that found in any other extensive, permanently submerged area.

Comparison of biomasses from the various areas investigated is even more difficult than a comparison of numbers. Frequently the larger and less abundant animals are not adequately represented in small samples and their inclusion then leads to distortion in the biomass calculations. In view of the fact that it is impossible to separate out this component in many of the investigations, such data are excluded from the comparison in Fig. 7.

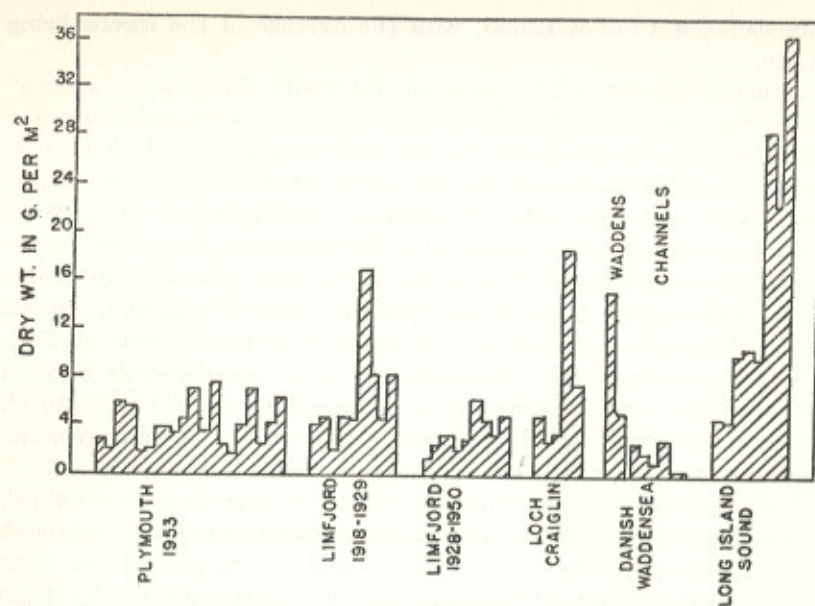

Figure 7. Comparison of the weight of the biomass of Long Island Sound with other regions. See explanation in Fig. 6.

In the present study the animals are separated after the manner of Holme (1953) into those that weigh more (large animals) than 0.2 g dry weight and those that weigh less (small animals), excluding molluscan shells. Keeping in mind the different mesh sizes used, the results of this study are directly comparable to those of the Plymouth studies; in Fig. 7 the components smaller than 0.2 g from both surveys are illustrated. Also included in Fig. 7 are the dry weights obtained from the Loch Craiglin fertilization experiment (Raymont, 1949), since all of the bottom samples consisted of small animals, with few if any larger organisms.

Other results used in Fig. 7 are obtained indirectly. The biomass figures for the long range investigation at Limfjord (Blegvad, 1928, 1951) were given in "rough weight," which is defined by Blegvad as "the weight of animals somewhat free of water and molluscs where the shell was opened to drain off excess water." This term, then, is equivalent to wet or live weight. Since Petersen and Jensen (1911) worked out the relationship between wet and dry (decalcified in the case of molluscs) weight for a number of the more common

animals found in Limfjord, we have used these ratios to change Blegvad's values to dry weights. When there was no equivalent dry weight percentage given, as in the case of some molluscs or polychaetes, an average of the range of values found in that group was used. For example, Petersen's (1918) dry weight range for small bivalves was 5-8%, for polychaetes 16-20%; thus the means of these groups, 6.5% and 18%, were used. Furthermore, the Danish workers included in their biomass values only those animals which were eaten by the plaice; this so-called "plaice food" consists of most of the smaller macrofauna found in Limfjord. Here it is assumed that plaice food is equivalent to that component of the biomass that weighs less than 0.2 g dry weight in the Plymouth and Long Island Sound surveys. While this is approximately true, a few forms like the gastropod *Nassarius*, which are included in the values for the Long Island Sound investigation, would be excluded from the plaice food determinations.

Since the populations found in the Danish intertidal areas (Smidt, 1951) were essentially the same as those in Limfjord, the same corrections were applied.

All of these localities, in common with Long Island Sound, are situated in shallow water, and some, as in the case of Limfjord and Loch Craiglin, are enclosed environs. It is apparent from Fig. 7 that, among the benthic macrofauna which were small enough to be adequately sampled, the biomass in Long Island Sound was much greater than that in the other localities, even when the peak value in Loch Craiglin, due to fertilization, is considered.

Reference to Fig. 6 shows that the numerical values for the waddens at Skallingen were higher than any of those from Long Island Sound, whereas the biomasses from Skallingen were much smaller, due primarily to the fact that the newly-settled spat at Skallingen contributed significantly to the numerical value but added little to the biomass.

Environmental and Biological Conditions. Spärek (1935) has reviewed the available results of bottom studies and has tried to relate them to various climatic and hydrographic factors. With other factors equal, he found that the shallower the water the greater the benthic biomass. Much higher values were obtained at Limfjord than in deeper waters in the same general locality. The smallest values were obtained in nutrient-poor waters, such as the Mediterranean, White Sea and East Greenland fjord, while maximal values

were found in areas of considerable water renewal surrounded by regions of high precipitation.

Long Island Sound is shallow, averages only about 20 m in depth, and has a maximum depth of about 100 m at the eastern end. This somewhat enclosed body of water is about 90 miles long and 15 miles wide. The drainage area is approximately 11 times greater than the Sound itself, and the annual volume of nutrient-rich freshwater drainage is approximately 35% of the volume of the Sound (see Riley's PHYSICAL OCEANOGRAPHY in this volume). The most important feature of the nontidal circulation in the Sound is a two-layer exchange; the lighter surface water, which has become somewhat deficient in nutrients as a result of phytoplankton growth, moves eastward out of the Sound while a more saline bottom current, whose nutrient-rich water is readily made available for photosynthesis, flows westward. Thus two mechanisms are responsible for the high concentrations of nutrients, the extensive freshwater drainage and the two-layer transport exchange just described.

During the midwinter nutrient maximum, the total nutrients under a unit column of water in the Sound are about the same as those in the English Channel despite the fact that the mean depth in the English Channel is 70 m compared with only 20 m in the Sound; thus the nutrients/m³ in the Sound are about 3.5 times greater than those in the Channel; furthermore, the longer the water column the less efficient the vertical transport of nutrients to the euphotic zone. It is not surprising, then, that the average standing crop of phytoplankton in the Sound is four times that in the Channel. However, the zooplankton populations in the Channel appear to be only slightly smaller (ratio of 3:4) than those in the Sound. Assuming all other things equal, this implies that the zooplankton in the Channel utilize a much larger fraction of the available phytoplankton than do those of the Sound. The portion of phytoplankton not consumed by zooplankton is available to other groups such as the bacteria in the water column and the macro-, meio- and microfauna and flora found on the bottom. Since the water column in the Sound is much shallower on an average than that of the Channel, the bacteria in the water column of the Sound would have less time to exploit the sinking phytoplankton cells. Thus, relatively huge quantities of plankton are probably available to the bottom dwelling organisms of Long Island Sound in contrast to those in the English Channel.

This hypothesis finds support in the results of the present investigation and in the studies of Mare (1942) and Holme (1953). Mare, using a 1.0 mm sieve, obtained 2,356 animals/m² in the Channel while the average of the means for eight stations in the Sound, using the same sieve size, was 16,446/m²; thus we have a ratio of 7 : 1. The mean total dry weight given by Holme for the Channel was 11.2 g/m² while the figure obtained for the Sound was 54.627 g/m². If one considers only the smaller more abundant animals, then the value for the Channel would be 4.0 g and that for the Sound 15.88 g/m². Therefore the bottom macrofauna values for the Sound appear to be about 4-5 times larger than those for the English Channel.

LIFE HISTORIES

Nephtys incisa. Of the samples taken in this study, this polychaete constituted a large fraction of the biomass in the softer sediments, where it made up 27.6, 31.7, 33.7, 34.6 and 39.1% of the small animals at Sts. 2, 7, 5, 3 and 8. On the harder sediments, where it was an insignificant member of the population, it comprised only 2.0, 0.8 and 0.9% of the biomass at Charles Island and at Sts. 4 and 1.

The dry weights of this animal have been plotted against the silt-clay content of the sediment, and, as shown in Fig. 8, *N. incisa* was either absent or gave quite low values. At higher concentrations of silt and clay the values rose rapidly to a maximum at about 26%. Thereafter the values dropped but remained relatively high until the sediment contained about 70% of silt and clay. Beyond this point the values diminished sharply but never reached the low found in the hardest sediments.

Apparently *Nephtys incisa* feeds indiscriminately in much the same manner as an earthworm. In many samples its entire gut was full, and the alimentary canal contained the sediment in which the animal lives. The interdigitating processes at the end of its everted proboscis are better adapted for taking in large portions of sediment (much as an earth-remover) than for seizing prey, and the proboscis, when inverted, brings the sediment to the beginning of the alimentary canal. As the sediment is carried backward through the gut, the organic matter is probably removed and utilized. In view of these observations, together with the fact that it comprises a third of the biomass in soft, highly organic sediments, it is difficult to accept the opinions that this species is a carnivore (Smith, 1932; Mare, 1942;

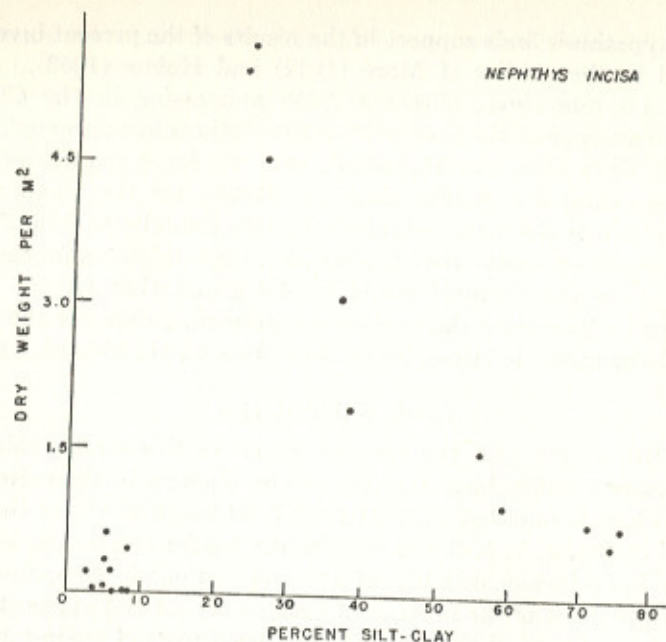

Figure 8. Relationship of biomass to sediment composition of *Nephthys incisa* (weight in grams).

Blegvad, 1914). It is much more reasonable to suppose that it is an ooze feeder.

Presumably the low values found in hard sediments (Fig. 8) are due to the low organic content characteristic of such substrates and to the compactness of the soil which offers significant resistance to burrowing animals. With an increase in the silt-clay component, conditions become more favorable for a nonselective deposit feeder until an optimal silt-clay is reached. Then beyond this point the larger content of organic matter reduces the mud to make conditions less favorable for aerobic animals.

Growth rates for *N. incisa* have been difficult to determine, since the large spread in the size dimension of the year-classes gave a high degree of overlap. In the first sample, taken on 11 August 1953, two year-classes appear to be adequately represented, the newly metamorphosed animals and the one-year-olds; the average animal²

² Weight of the animal of mean length among animals in sample of a given year-class.

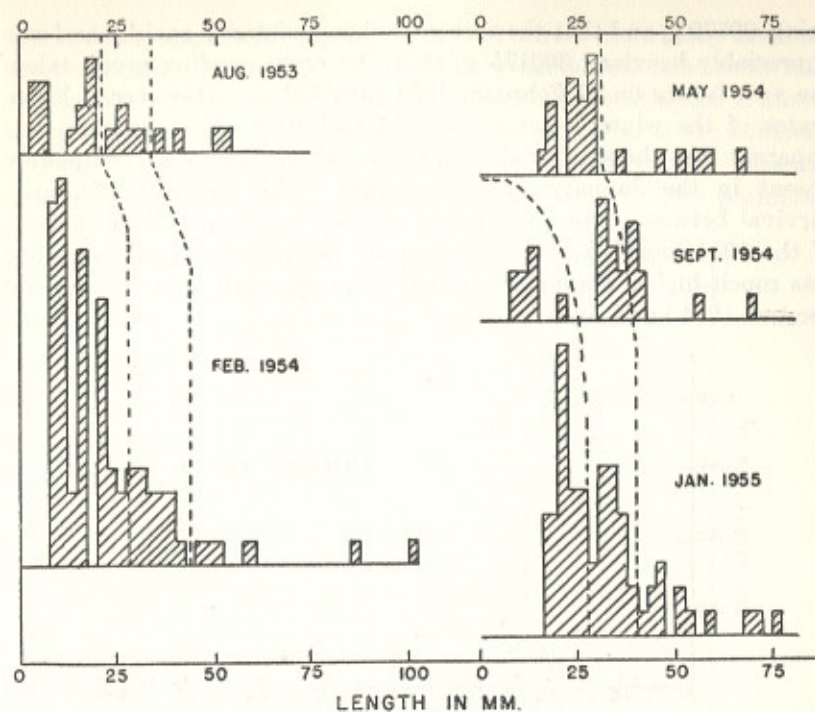

Figure 9. Histograms showing size distribution of *Nephthys incisa*. Interpretation of the limits of the year-classes is indicated by dotted lines.

in this group weighed .000230 g. The sample of 9 September 1953 gave adequate numbers of only the zero year-class, with the average animal weighing .000350 g; thus there were new recruits added to the zero year-class after the 11 August sampling. The February 1954 histogram (Fig. 9), a composite of four samples, shows that the zero year-class at this time weighed .000533 g and that the one-year-olds weighed .00803 g. By 20 May 1954 the zero year-class had grown rapidly to .00240 g, and by 23 July 1954 representatives of the newly spawned year-class were present, the average animal in this latter group weighing .00032 g, the one-year-olds .00350 g. By 19 September 1954, the one-year-old class doubled its weight to .00710 g while the weight of the zero year-group remained essentially the same as that in the 23 July sample, probably due to increased recruitment. The final sample, taken on 13 January 1955, showed that the rate of increase in the one-year-old group was somewhat reduced, its weight

being .00770 g, and that the zero year-class had grown rapidly and was appreciably heavier (.000175 g) than the corresponding group taken the year before on 10 February 1954 (.000533 g). However, if histograms of the winter samples of 1954 and 1955 are compared, it is apparent that the smaller sizes of the zero year-class were completely absent in the January 1955 histogram. This implies differential survival between animals spawned at the beginning and at the end of the 1954 breeding season; it is quite probable that the mortality was much higher among those that were spawned later, because of the two 1954 hurricanes.

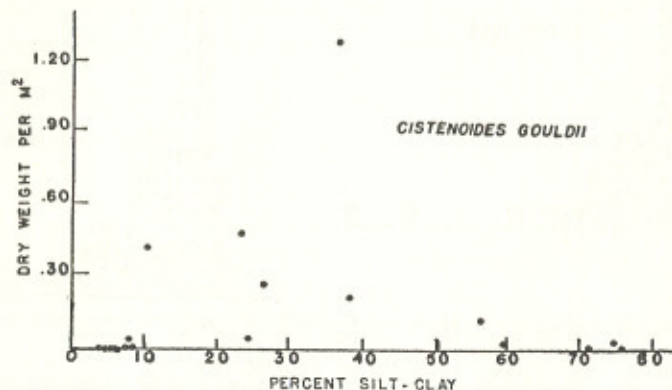

Figure 10. Relationship of biomass to sediment composition of *Cistenoides gouldii* (weight in grams).

A fair sample of the two-year-old class was also found in the January 1955 sample, the average animal weighing .0385 g (not shown in Fig. 9).

Cistenoides gouldii. The trumpet worm, a minor form at Charles Island, comprised only 0.7% of the population, while at Sts. 8, 5, 3, 2 and 7 it formed 2.1, 2.7, 3.3, 4.3 and 11.1% of the small animals. It was never encountered at St. 4, and at St. 1 it was present only as a trace of the biomass, constituting less than 0.1% of the population.

When the dry weight in a given square meter was plotted against the silt-clay content (see Fig. 10), it was evident that this polychaete was most abundant in intermediate sediments, since all of the higher values were confined to the 10-60% range of silts and clays.

The distribution pattern can best be understood in terms of its mode of life, which is probably quite similar to that of the closely related

European amphictenid, *Pectinaria koreni*, whose life history has been worked out by Watson (1927). The polychaete lives head downward in a conical sand tube which is open at both ends and which is almost completely buried, only the smaller end projecting out of the sediment. Through this opening, sand and faeces are discharged by muscular contraction and water is taken in for respiration. The prominent

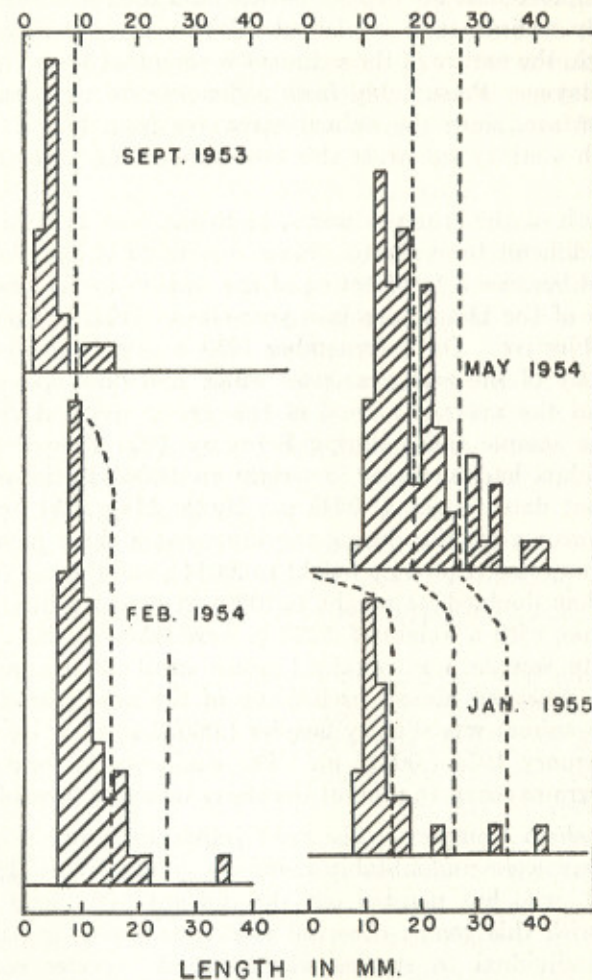

Figure 11. Histograms showing size distribution of *Cistenoides gouldii*. Interpretation of the limits of the year-classes is indicated by dotted lines.

large golden combs at the anterior end are used for digging, and the tentacles about the head have prehensile tips which bring sediment from above the head to the mouth; in time the cavity created by the digging causes a cave-in of additional nutrient-rich surface sediments. After extracting the organic matter, the animal either discharges the residual sediment at the surface or uses the sand for tube building. Thus the amphictenids are deposit feeders, and their absence from the sterile sandy sediments is explained. When the silt-clay content becomes high, the nature of the sediment is such that the soil becomes sticky or clayey. Presumably fresh sediments do not drain down from the surface, since the animal excavates from below. At any rate, in such a sticky substrate this mode of feeding becomes highly inefficient.

The growth of the trumpet worm, as in the case of certain other forms, was difficult to evaluate. Since a number of samples had to be discarded because a fair fraction of the smaller forms was missed, the division of the histograms into year-classes (Fig. 11) must once again be subjective. On 9 September 1953 a sample was composed predominantly of the zero year-class which had been spawned that summer, and the average animal of this group weighed .000125 g. A composite sample taken during February 1954 showed that the mean individual had increased in weight to .00041 g, the one year-group at that date weighing .0045 g. By 20 May 1954 both year-classes had grown rapidly during the intervening three months; the zero year-group had tripled its weight to .0014 g and the one year-class had more than doubled its weight to .0094 g; representatives of the two year-class, with a weight of .0223 g, were taken at this time also. No adequate sample was obtained again until 13 January 1955; this sample consisted almost exclusively of the new year-class, and the average animal was slightly heavier (.00072 g) than its counterpart of February 1954 (.00045 g). The similarity in form of both winter histograms seems to support the above interpretation of growth.

The *Ampelisca* Complex. The most important amphipods found in this survey were undoubtedly members of the genus *Ampelisca*. Reid (1951), who has pointed out the difficult taxonomic problem in dealing with this genus, observed that it is almost impossible to assign an individual to species within certain species complexes. No single animal has all the given characteristics of the species and individuals differ among populations regardless of whether the col-

lections are from widely scattered areas, from different habitats in the same area, or from a single locality.

Similar difficulties to those of Reid were encountered in trying to determine the specific identity of amphipods of this genus from the Sound. The two *Ampelisca* forms most frequently encountered fall within the *diadema-spinipes-tenuicornis* complex and are probably what Holmes (1903) and Kunkel (1918) have referred to as *Ampelisca spinipes*, but due to the confusion within the group, it was decided to leave both forms undescribed temporarily. For present purposes they are separated on the basis of size difference and habitat preference and are tentatively called *Ampelisca* A and *Ampelisca* B, hereafter referred to as merely A and B.

A, which was found in the harder sediments of the Sound, particularly at Charles Island and at Sts. 1 and 4, constituted 9.6, 5.2 and 2.5% of the small animals and 15.0, 29.1 and 2.8% of the infauna respectively at these same stations. When the sediment contained 30% or more silt and clay, A was replaced by B, a morphologically identical though significantly smaller form. At Sts. 8, 7, 3 and 2, B made up 4.1, 2.6, 0.5 and 0.8% of the small animals and only slightly greater percentages of the infauna: 4.6, 2.6, 0.6 and 0.1%. The fact that there is no significant difference in size within the range of either A or B indicates that this difference is probably due to genetic rather than environmental causes.

Both types, with essentially the same life cycle, produce two generations a year—a short summer and a long overwintering generation; the winter population of both forms first appeared during September and October 1953.

In the case of A (Fig. 12) the young were 2.0 mm long upon becoming free living, and at this time the average individual weighed .000035 g. By 8 November 1953 the average animal was .00015 g; by 20 December 1953, .0005 g; by 19 April 1954, .0013 g; by 30 April 1954, .0014 g; and finally, by 17 May 1954, .00162 g. On this last date the overwintering generation was ready to spawn. During June, few large individuals were found, but towards the end of that month great numbers of the new generation were evident. These grew rapidly, and by 20 August 1954 they were mature and weighed .00055g. Thus the reproducing adult of the summer population was only about one-third as heavy as the adult of the winter stock.

The cycle in B was less clear. During October 1954 the average

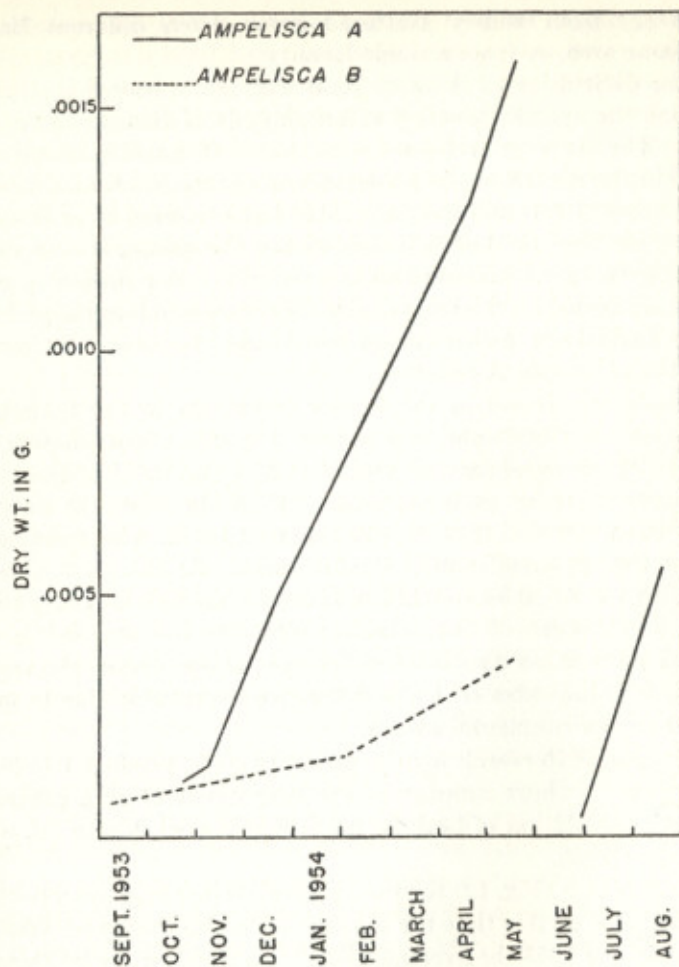

Figure 12. Growth (in grams) of *Ampelisca A* and *Ampelisca B*.

individual weighed slightly less than its counterpart in A, and on 3 February 1954 it was .000163 g, or less than a quarter the weight of A at that time (Fig. 12). This slower growth rate continued so that by 20 May 1954 the animal was mature and weighed .000362 g, its weight still being less than a quarter of the weight of A on the corresponding date. The other generation of B (summer generation) was much more difficult to follow than that of the overwintering

generation. The summer adult was much smaller than the winter adult and its breeding period was somewhat extended; hence it was difficult at times to separate the two generations of B.

While both forms have a fairly wide though nonoverlapping distribution in regard to sediment type, large concentrations of these animals were found in a narrow sediment range. In Fig. 13 the dry weight of A per square meter is plotted against the silt-clay content; location and time have been omitted. In this figure it is evident that the points fall into two groups: a cluster of low values where

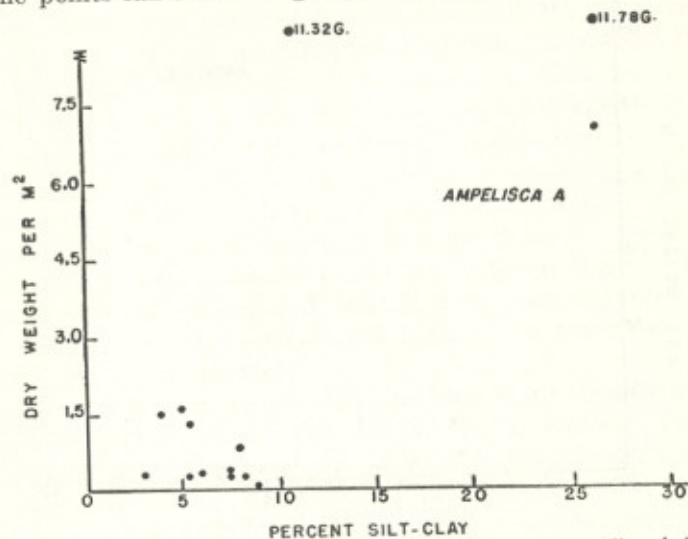

Figure 13. Relationship of biomass to sediment composition of *Ampelisca A* (weight in grams).

the silt-clay percentage was low (< 9%) and another cluster of values which were much higher and which increased with increasing percentages of silt and clay. But no A individuals were found in sediments containing more than 30% of silt and clay.

These observations are interpreted in the following manner. Since members of the genus *Ampelisca* are filter-feeders and since food is taken out of the water immediately over the bottom, the food that is available to the animal is directly related to the amount of water that passes over the animal. Since the coarser sediment reflects more pronounced current activity than the silt-clay sediment, primarily because few of the finer particles (silts and clays) have

settled out, it is not surprising that the species with the larger total biomass, *Ampelisca* A, was found in coarser sediments. However, extremely coarse sediments are unfavorable because the extreme compactness of the sediment makes burrowing by this animal difficult.

For B, the silt-clay content is plotted against dry weight in Fig. 14, but here the results are not as evident as they were for A. However, it is clear that at high silt-clay concentrations the biomass of this amphipod is small; since currents over such sediments are probably

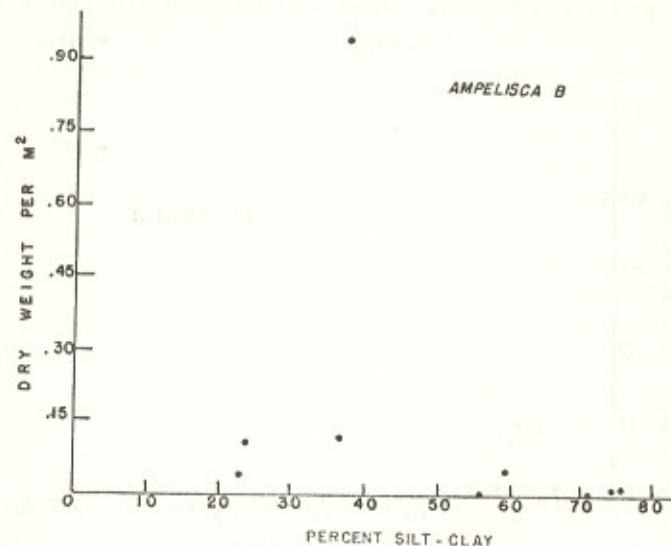

Figure 14. Relationship of biomass to sediment composition of *Ampelisca* B (weight in grams).

weak, an unfavorable environment is afforded filter-feeders. In addition, these sediments, being highly flocculent, may readily clog the filtering apparatus, and finally, in highly organic sediments the oxygen content below the surface of the soil can be severely reduced, making conditions unfavorable for aerobic organisms. At lower concentrations of silt and clay the biomass increased, presumably because of the less flocculent, less reduced nature of the sediment and the greater velocity of the bottom current.

During this study, none of the smaller B forms were found in sediments containing less than 35% silt and clay, and none of the larger A forms were found in sediments containing more than 30%. The

lack of overlap between A and B indicates a high degree of competition between these similar forms, and the larger dry weight measurements for A reflect the more favorable conditions for a filter-feeder on coarser rather than on finer sediments. Thus, exclusion of the larger A form from the finer sediments may indicate that the smaller B form is more efficient in filtering the smaller food particles.

In every sample that contained either A or B, females always predominated; usually there were at least 15 times more females than males, and frequently there was not even a single male. Recently Barnard (1954) reported that he seldom found the adult male of species of *Ampelisca* in abundant material from the eastern Pacific.³ Somewhat earlier Reid (1951) had pointed out that many of the females, particularly in the *diadema-spinipes-tenuicornis* complex, are in reality intersexes. According to him, they resemble the female morphologically but lack the brood plates or oostegites and possess two slight protuberances, the copulatory hooks characteristic of the male, near the midline immediately in front of leg 7. Undoubtedly earlier workers were completely unaware of the widespread intersex phenomenon in this group and, since various workers probably used gynomorphic males to describe the female, the taxonomic picture was complicated still further.

So far as is known, no attempt has been made to determine the relative proportion of intersex to female in nature. Therefore, the pertinent characters necessary for an appraisal of such a relationship were observed on 100 adults of the A group, taken from the Charles Island sample of 30 April 1954. Results regarding the presence or absence of setal tufts on the antennae were variable, although in most cases they were either female or were approaching the female condition. The character of the third uropod was in every case female. Precisely 50% of the animals possessed oostegites, and in every case these same animals lacked copulatory hooks; conversely, precisely 50% possessed copulatory hooks but lacked oostegites. Thus it appears that females and gynomorphic males occur in about equal numbers, while andromorphic males constitute only a mere trace of the population. The genetic basis for this peculiar ratio is difficult to postulate.

³ A male can be readily distinguished from the female by the longer first antenna, the presence of setal tufts on both the lower surfaces of the peduncle of the second antenna, and by the larger spines on the third uropod.

Yoldia limatula. This species was commonly found in certain sediments, primarily at Sts. 3, 2, 8 and 7 where it constituted 4.7, 5.5, 9.7 and 19.3% of the biomass of small animals; at Charles Island and at Sts. 4 and 5 it was entirely absent, and at St. 1 it comprised only 1.1% of the biomass.

In Fig. 15 the dry weight values are plotted against silt-clay content of the sediment; here again location and time are omitted. *Y. limatula* is either excluded from the coarser sediments altogether or is present in only small numbers, and dry-weight values remain insignificant until the silt-clay content exceeds 30%, after which abundance increases markedly, with maximal values being reached at about 40% silt-clay. At still higher percentages the values drop off signifi-

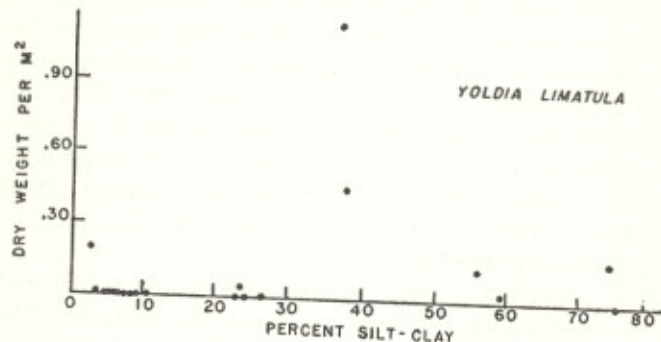

Figure 15. Relationship of biomass to sediment composition of *Yoldia limatula* (weight in grams).

cantly, though small populations are found in sediments with an extremely high fraction of silts and clays (> 70%).

Drew (1899) has shown that this species, in common with other protobranchiate molluscs, feeds by means of palp proboscides. The animal, when feeding, raises the posterior third of its body above the sediment in an almost perpendicular position and then extrudes the palp proboscides so that at least one is inserted into the substrate. Thus *Y. limatula* is a deposit-feeder which derives its food from the organic-rich soil beneath the surface of the sediment.

Its feeding habits explain in large measure the distribution pattern shown in Fig. 15. Its absence from the coarse sediments is due to its inability to thrust the proboscides into the hard substrate, and furthermore, the organic content of such sediments is low. Also, in its exposed feeding position the animal must be able to burrow rapidly

into the bottom to escape its enemies, a feat which is difficult to perform in the coarser substrates.

Fig. 16 shows the size composition of *Y. limatula* at different dates. There appears to be no sharp separation between year-classes, hence interpretations must be subjective, but not to the same degree as in some other species. The dotted lines indicate how the year-classes are separated. The first sample, taken in early August 1953, indicated two modes: the one year-group with an average individual weight of .0104 g and the recently spawned zero year-class with a weight of .0010 g. By 9 September 1953 the one year-group had increased to .0151 g, the zero year-group to .00165 g. A composite sample taken in February 1954 showed weights of .00438 g and .0230 g for the zero and one year-classes respectively, and the 20 May 1954 sample showed that the animals had grown rapidly enough so that the zero year-class now weighed .0098 g, the one year-group .0342 g. This was the last date on which adequate numbers of the one year-class were obtained. On 23 July 1954 a new generation with an average individual weight of .00085 g was present, and the mean animal of the recent zero year-class, now the one year-group, weighed .01272 g. By 10 September 1954 the new generation was .00277 g, while individuals of the one year-group were found in so few members that no analysis could be made. Finally, on 13 January 1955 a large sample that gave adequate representation of both classes showed that the new generation weighed .0059 g and the older class .0255 g.

Independent evidence from growth ring measurements tends to support this growth interpretation. The size of the first winter ring,⁴ measured in five animals from the 9 September 1954 sample, varied in length from 9.2 to 12.0 mm, with a mean of 10.48 mm. This agrees well with the mean winter values, 9.40 and 10.59 mm, found for February 1954 and January 1955. Six other specimens with two winter rings, from the January 1955 sample, were also observed; the length range of the first ring was 6.5–11.0 mm, with a mean of 9.25 mm, while the variation in the size of the second ring was 16.0–20.5 mm, with a mean of 18.58 mm. This latter mean was higher than those found in the February 1954 sample (15.5 mm) and in the January 1955 sample (16.9 mm). However, the winter ring in those later samples had not been laid down; probably there was still a small increment in growth before this occurred.

⁴It can be shown from the size distribution data that the ring is laid down early in the spring.

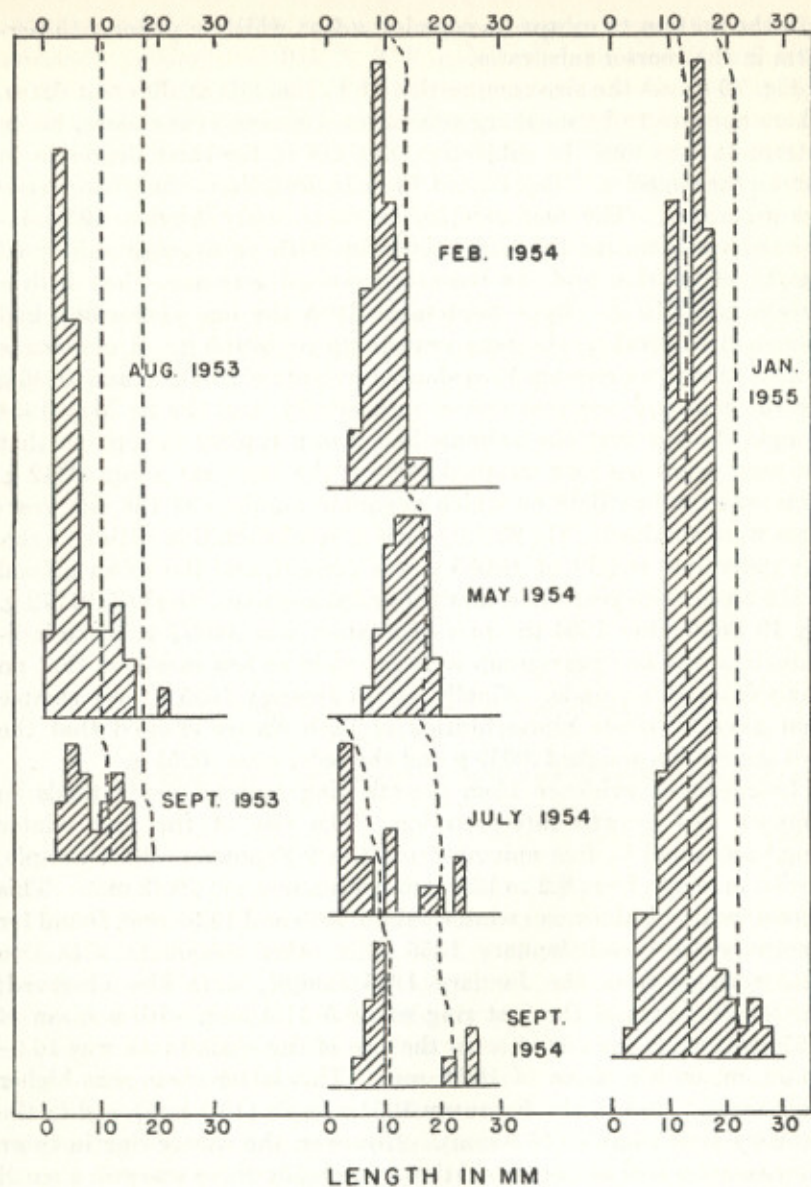

Figure 16. Histograms showing size distribution of *Yoldia limatula*. Interpretation of the limits of the year-classes is indicated by dotted lines.

If the two winter histograms (February 1954 and January 1955) in Fig. 16 are compared, those portions that represent animals less than 14 mm in length are essentially similar. This implies that those portions represent the zero year-class at about the same stage of growth in 1954 and in 1955. However, in these same histograms the proportion of zero- to one-year-olds is much more varied. Since the zero year-class was only slightly larger than the one year-group in January 1955, it seems probable that there was a poor set of *Y. limatula* in 1954.

Nucula proxima. This is a ubiquitous lamellibranch of the softer sediments. At Sts. 7, 8, 3, and 2 it formed 12.5, 19.1, 23.4 and 42.9%

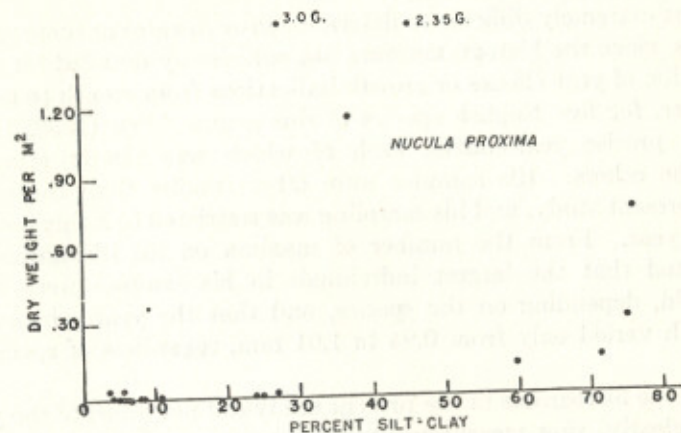

Figure 17. Relationship of biomass to sediment composition of *Nucula proxima* (weight in grams).

of the biomass of small animals, whereas at Charles Island and at Sts. 4 and 5 it constituted a mere trace with less than 0.1%. Its restriction to the softer sediments is clearly illustrated in Fig. 17, where a sharp break is apparent at a silt-clay content of about 33%. At lower silt-clay concentrations the dry weight values are extremely small, while at higher concentrations the values are appreciably higher.

This species, like other protobranchs such as *Y. limatula*, possesses a large foot which is specialized for burrowing into the softer sediments (Yonge, 1939). Normally this small lamellibranch, which lies just beneath the surface, makes a small opening to the surface at its

posterior end for the discharge of faecal pellets. This animal, in common with *Y. limatula*, utilizes palp proboscides in feeding, the tips of which collect sediments which are then carried by means of a ciliated groove to the base of the proboscis. Moore (1931) has pointed out that *N. proxima* can resist anaerobic conditions for a certain period of time, hence the somewhat reduced soils of high organic content which characterize high concentrations of silt and clay form a satisfactory source of food that can be exploited by such a deposit feeder. Conversely, hard substrates offer meagre nutrients and constitute an unfavorable medium for burrowing. The distribution of *N. proxima*, as shown in Fig. 17, is approximately what could be postulated from its life history.

It was extremely difficult to determine growth rates in these minute animals, since the histograms were not sufficiently detailed for either separation of year-classes or growth indications from month to month. However, for five English species of this genus, Allen (1953; 1954a) showed precise year-classes, each of which was clearly separated from the others. His samples were often smaller than those used in the present study, and his sampling was restricted to a single season of the year. From the number of maxima on his histograms, he postulated that the largest individuals in his samples were 12-20 years old, depending on the species, and that the yearly increment in length varied only from 0.94 to 1.01 mm, regardless of species or age.

Since the histograms in the present study did not indicate the year-classes clearly, ring measurements were used as an alternative. In a sample taken at St. 2 on 23 July 1954, 10 animals possessing two rings had a mean length of 2.37 mm and a weight of .00027 g, 47 with three rings had a mean length of 2.94 mm and a weight of .00069 g, and 8 individuals with four rings had a mean length of 3.51 mm and a weight of .00106 g. A sample from St. 7, taken on January 13, 1955, gave a mean length of 2.4 mm for 14 animals with two rings and of 2.98 mm for 43 animals having three rings, this last length being equivalent to .00071 g. It is doubtful whether the above measurements give a precise picture of growth in *N. proxima*. Nonetheless, this information may be utilized in gaining some concept of the general order of growth in this animal.

Pandora gouldiana. This lamellibranch was found during the survey at one time or another at all eight stations. At seven stations

it formed only a minor part of the population, ranging from less than 0.1 to 2.1% of the biomass of small animals, but at Charles Island it comprised 14.0% of the population. If the samples of 17 August and 23 October 1953 at Charles Island are disregarded, since the samples on those dates contained a much higher percentage of silt and clay, then *P. gouldiana* would make up 19.0% of that station's biomass.

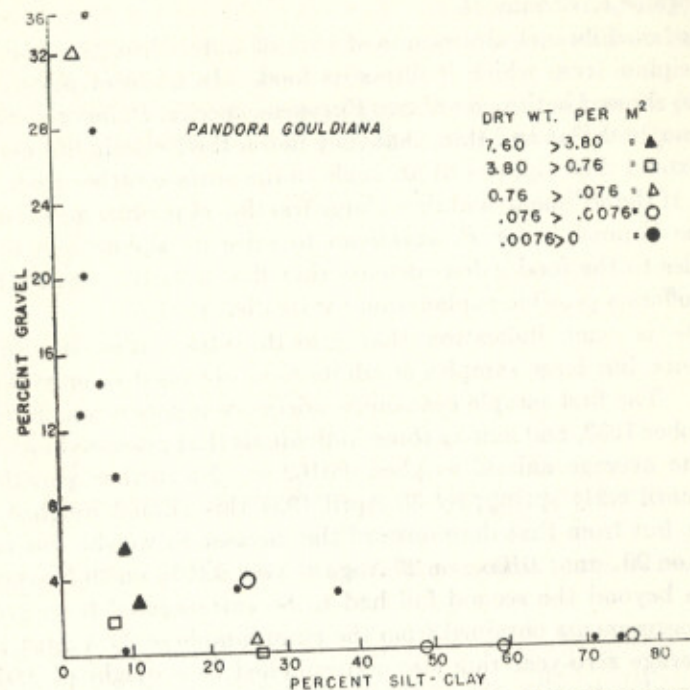

Figure 18. Relationship of biomass to sediment composition of *Pandora gouldiana* (weight in grams).

In Fig. 18 the dry weights are plotted against silt-clay as well as gravel content, and it is seen that all of the high values are crowded into that corner of the graph where percentages for both of these fractions are low. Charles Island was the only station in the survey that contained such a sediment composition.

The fact that this lamellibranch is a suspension feeder may help to explain its distribution pattern. Like the *Ampelisca* forms, the food available to the animal is directly related to the amount of water that passes over it in a given period of time, and since coarser sedi-

ments reflect greater current activity, it is not surprising that the silty sediments appear unfavorable for *P. gouldiana*. Its exclusion from the gravelly sediments, however, is more difficult to explain. If we note the sudden sharp break from high to low values along the ordinate axis, we discover that a small increase in the percentage of gravelly sand can convert the sediment from a favorable to a highly unfavorable environment.

This lamellibranch draws in a stream of water through a relatively short siphon from which it filters its food. In a recent paper, Allen (1954b) showed in the case of two European species, *P. inaequalis* and *P. pinna*, both flat and thin, that they lie on their side in life and that they extend their siphons at an angle to the surface rather than vertically. If the sediment contains a large fraction of pebbles and stones, it may be impossible for *P. gouldiana* to raise its siphon above these obstacles to the food-laden currents that flow over it. Such a hypothesis offers a possible explanation for its distribution.

There is some indication that growth rates varied in different sediments, but large samples of adults were obtained at only Charles Island. The first sample containing adequate numbers was taken on 23 October 1953, and among those individuals that possessed no winter ring, the average animal weighed .00162 g. No further growth was noted until early spring; by 30 April 1954 this animal weighed only .0020 g, but from that date onward the increase in weight was rapid: .0045 g on 20 June; .0106 g on 20 August; and .0210 g on 30 November. Growth beyond the second fall had to be extrapolated from growth ring measurements obtained from the large sample of 20 August 1954. The average zero-year ring size corresponded to a weight of .0030 g, which implies that the so-called winter ring was actually laid down in early spring. The mean-length first-year ring corresponded to a weight of .0240 g, and a year later (20 August 1955) the weight had doubled and the average-length animal weighed .0487 g. Too few older animals were found to give valid results.

Apparently there was a poor set of this species during the summer of 1954, since few zero-year animals were found. In this it agrees with *Y. limatula* and *N. incisa*. Perhaps all invertebrates having planktotrophic larval stages during the late summer and early fall suffered similarly from hurricanes "Carol" and "Edna" which hit New England on August 31 and September 11.

Macoma tenta. Extensive sampling reveals that this species has a somewhat uneven distribution in the Sound; even at the locations where this lamellibranch was present, quantitative values fluctuated widely from sample to sample. Unfortunately, Fig. 19, with only a single significant value shown (Charles Island, 23 October 1953), does not give a clear picture of the distribution of *M. tenta*. At Charles Island and at Sts. 1, 8, 7 and 4, it averaged on a yearly basis 12.7, 1.2, 0.8, 0.5 and 0.1% of the small infauna, and at Sts. 2, 3 and 5 it was absent from all samples.

This species is a deposit-feeder, but unlike *Y. limatula* or *N. proxima*, it feeds on the surface. The siphons, long and extremely mobile,

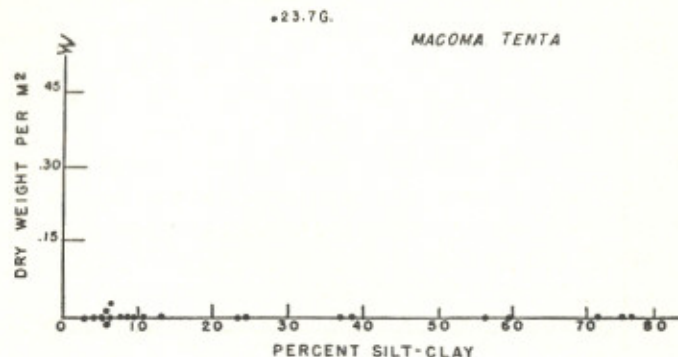

Figure 19. Relationship of biomass to sediment composition of *Macoma tenta* (weight in grams).

are separate, and the inhalent siphon moves over the surface to draw in food. As a result of its narrow lumen, the inflow current is small but powerful (Yonge, 1949). By this suction device it can actually tear bottom diatoms from the substrate.

In Long Island Sound this lamellibranch feeds on settled detritus, and the availability of this food probably determines its distribution. In sediments of low silt-clay content where there is little net deposition of food and in those of high silt-clay content where there is reduced oxygen and flocculence, *M. tenta* probably finds the environment unfavorable. From the limited data that are available, it appears that this species is found primarily in sediments having a silt-clay content of 15-35%. Since few samples were taken from substrates of this type, more adequate sampling will be necessary to determine

whether or not this species is an important constituent of the populations that inhabit these sediments.

Lyonsia hyalina. This is a moderately common lamellibranch in some of the sediments. At Charles Island and at Sts. 5, 1, 4, 8 and 7 it comprised 10.4, 3.2, 2.8, 1.6, 1.3 and 0.4% of the biomass of the small animals. At St. 2 it was absent and at St. 3 it comprised less than 0.1% of the population. From Fig. 20 it is obvious that this species was found primarily in the harder substrata and that it was

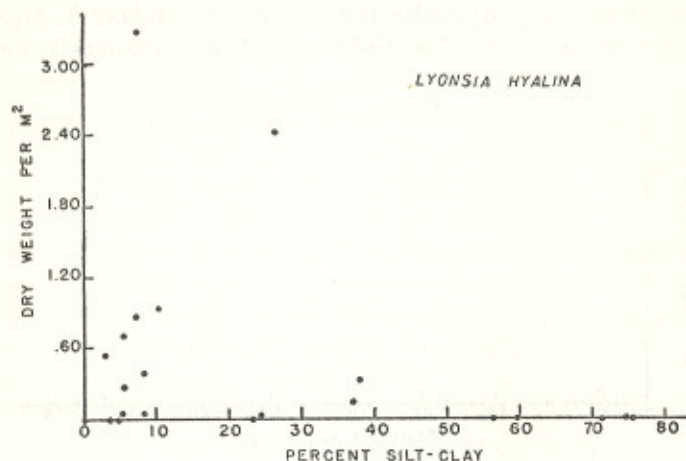

Figure 20. Relationship of biomass to sediment composition of *Lyonsia hyalina* (weight in grams).

largely absent from those sediments having a silt-clay content greater than 50%. The distribution pattern is in essential agreement with the suspension feeding habit of this animal. *L. hyalina's* thin and extremely delicate shell is an unexpected feature in a lamellibranch that inhabits a hard substrate, but, once buried, it is probably sedentary (Yonge, 1952)—a fact which largely eliminates the abrasive action of sand granules on the shell. In addition, further protection is afforded by the sand particles which adhere to the periostracum.

Mulinia lateralis. Although this diminutive lamellibranch has a wide distribution in the Sound, over much of its range it makes only an insignificant contribution to the biomass. Even at those stations where it was common, its abundance varied widely from date to date.

At Charles Island and at Sts. 8, 7, 1, 5 and 3 it constituted 10.6, 2.4, 1.2, 0.7, 0.4 and 0.2% of the small animals, and at Sts. 2 and 4 it formed hardly a trace of the population, comprising less than 0.1%. However, it was occasionally encountered in great quantity, as at Charles Island on 17 August 1953, when it had a value of 36.10 g/m².

In Fig. 21, dry weight values of this animal are plotted against silt-clay content; at low silt-clay percentages these values are variable though generally low, whereas at silt-clay concentrations of about 20% the values rise sharply. Note that all major dry weight values

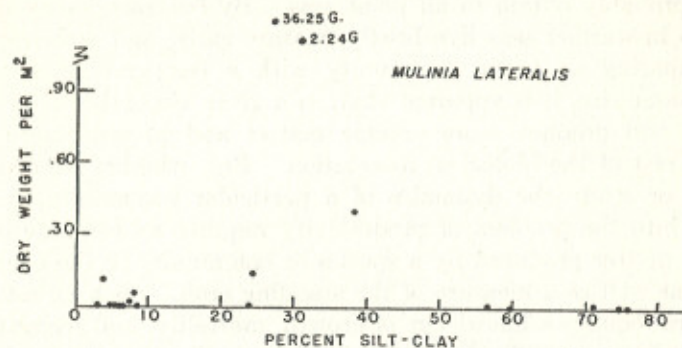

Figure 21. Relationship of biomass to sediment composition of *Mulinia lateralis* (weight in grams).

are confined within the 20–40% range. At concentrations greater than 40%, it is either absent or its biomass is extremely low.

Like many other lamellibranchs, *M. lateralis* is a filter-feeder. In gravelly sediments, as at Sts. 1 and 4, this minute clam would encounter difficulty in raising its siphon above large particles to the unobstructed current, and in sediments with high silt-clay concentrations the velocity of the current flowing over it would be much reduced. In addition, the high organic content of such soils absorbs oxygen and thus creates an even more unfavorable environment. It seems logical, then, to assume that optimal conditions for *M. lateralis* would be found in sediments with intermediate concentrations of silt and clay, an assumption which is in agreement with the picture given in Fig. 21.

PRODUCTIVITY⁵

Thus far in this paper, terms with static connotations, such as "standing crop" or "biomass," have been employed while the word "productivity" has been avoided purposely. However, use of the term standing crop as a basis for comparing the productivity of various regions can be quite misleading, hence it is essential to appraise briefly the connotation of productivity. Thorson (1936) has shown for northeast Greenland seas that the bottom fauna is characterized by animals that live long, grow slowly and mature late, features which probably obtain in all polar seas. By contrast, many of the animals in warmer seas live briefly, mature early, and grow rapidly. In comparing an arctic community with a temperate community of the same size, it is apparent that, in a given time, the latter community will produce more organic matter and provide more food for the rest of the biological association. But, whether we compare regions or study the dynamics of a particular community, a clear insight into the problem of productivity requires an estimate of the organic matter produced by a species or community in the course of a year as well as a measure of the standing crop. Such an estimate therefore requires a knowledge of growth, mortality, and recruitment, hence it is more difficult to obtain than a simple measure of the standing crop. Such estimates will be developed for the present survey insofar as data permit, and it is to this aspect of the work that the term "productivity" is restricted.

To date, Jensen (1919) is the only investigator who has attempted to study benthic community from the point of view just discussed. Jensen, with data gathered each spring and fall from 1909-1917 in Thisted Bredning, one of the shallow enclosed bays of the Limfjord, developed his work on the basis of the following definitions:

Stock: quantity of individual species, expressed in wet weight/m².

Rest stock: amount of stock left in the following spring.

Consumption: quantity of individual species eaten during the year, calculated from one series of spring samples to the next.

Growth increment: increment of the stock (in wet weight) during one year to the death of the individual specimens

⁵ Although there is considerable literature on the productivity theory (Lindeman, 1942; Riley, *et al.*, 1949; Park, *et al.*, 1946), none of these has a practical bearing on the present investigation.

$$\left(\text{i.e., growth increment} = \frac{\text{consumption} + \text{rest stock}}{\text{stock}} \right).$$

Uppgrowth: weight of 0-group/m² (i.e., upgrowth = recruitment).
Animal production = sum of growth increment + upgrowth.

If Jensen found that a given species had more than one year-class, then each year-class was treated separately. For 1910-1915, Jensen obtained yearly productivity values that ranged from 1.00-3.23 times the values of the standing crop.

The primary difficulty with his procedure lies in the manner of computing consumption, which, by Jensen's definition, indicates that the mean mortality of an individual species during the time interval of one year would occur precisely at the end of six months; furthermore, this mean mortality would have both the mean length and mean weight of all animals that die during this interval of time. If we assume that predation is occurring at a constant rate, then a constant fraction of a continuously diminishing population is dying so that the mean mortality must occur well before the end of the six-month period. Since in most organisms the weight is proportional to the cube of the length, the mortality of mean weight must occur somewhat later than the mortality of mean length. If a long interval of time is measured, as in Jensen's work, then large errors are introduced and the results obtained are obviously too high.

In the present study a different approach has been attempted. All samples of a given species at a given station were divided into year-classes on the basis of growth histograms shown in the previous section. In the case of certain molluscs, growth rings were also used. For each year-class, the mean individual weight was determined by dividing the total weight of the year-class by the number of individuals in it.

Fig. 22 shows two separate curves, one being the log of the mean individual weight, the other that of the mean number plotted against age, the ages having been determined from year-classes. At three-month intervals the mean weight of the individual and the number of individuals at that weight were determined. The number of animals present at a given interval (N_{a+1}) were subtracted from the number present at the previous interval (N_a) to obtain the number that had died in the intervening time ($N_a - N_{a+1}$). The average weight of the individual during the intervening period of time was

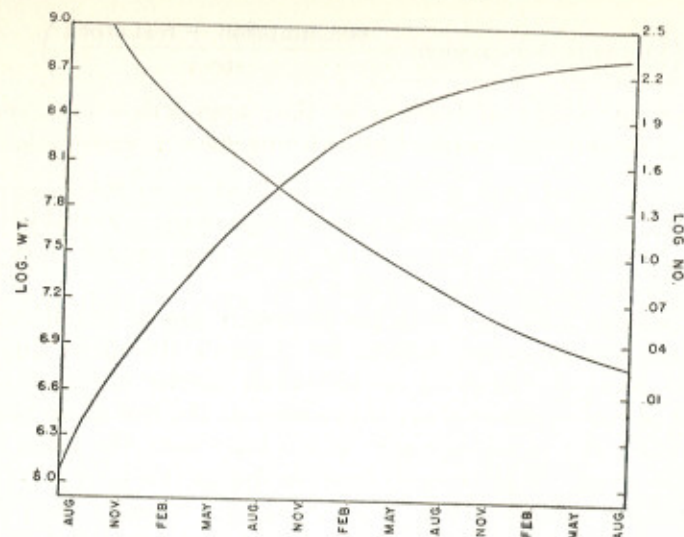

Figure 22. Relationship of numbers and weight to age in *Nephthys incisa*.

obtained by adding the mean individual weight at the beginning (W_a) and at the end of the interval (W_{a+1}) and dividing by two $\frac{W_a + W_{a+1}}{2}$. This value was then multiplied by the number of animals that had died during the interval. The resultant figure represents the mortality by weight that had occurred during the intervening period $\left[(N_a - N_{a+1}) \cdot \frac{(W_a + W_{a+1})}{2} \right]$. The same procedure was used for all of the three-month intervals. Summation of these figures gave the mortality by weight that occurred during the year.

The amount of organic matter produced by a species in the course of the year was obtained by adding the figures for mortality to those of the terminal population weight $[(W_n) \cdot (N_n)]$. This latter value actually contributes to the total mortality figure of the following year, but under steady-state conditions this may be assumed equal to that received under similar conditions from the previous year. The sum of both of these figures is the productivity of the species.

Calculations for the polychaete *Nephthys incisa*, given in Table VI, show productivity to be 2.16 times more than the standing crop.

TABLE VI. PRODUCTIVITY DETERMINATION IN *Nephthys incisa*

Date	0 year-class		1 year-class		2 year-class	
	Wt.	No.	Wt.	No.	Wt.	No.
8/1/53	.3119	1254.53	.1267	33.29	.7344	19.99
2/3/54	.7210	1159.38	1.5892	171.84	.4333	12.31
5/20/54	2.0166	666.29	4.0950	143.03	2.9413	47.65
	3.0495	3080.20	5.8109	348.16	4.1090	79.95
\bar{M} sample wt. =	1.0165		1.9369		1.3697	
\bar{M} No./sample =	1026.73		116.05		26.65	
\bar{M} wt./individual =	.00099		.01669		.05135	
\bar{M} standing crop =	4.3231 g/m ²					

Year-class	Month	Wt./indiv. (W)	No. (N)	$N_a - N_{a+1}$	$\frac{W_a + W_{a+1}}{2}$	Mortal.
0	Aug.	.0001326	2348.4	828.40	.0002700	.2237
	Nov.	.0004074	1516.2	581.40	.0008597	.4998
	Feb.	.001312	934.8	387.98	.002281	.8850
	May	.003250	546.82	229.22	.004921	1.1280
1	Aug.	.006592	317.60	123.96	.009226	1.1436
	Nov.	.01186	193.65	73.19	.01486	1.0876
	Feb.	.01787	120.46	44.84	.02109	.9457
	May	.02432	75.62	28.65	.02797	.8014
2	Aug.	.03162	50.01	15.66	.03618	.5664
	Nov.	.04074	34.35	9.04	.04590	.4149
	Feb.	.05105	25.31	5.24	.05551	.2909
	May	.05997	20.06	4.33	.06426	.2782
	Aug.	.06855	15.73	—	—	—

Total = 8.2652

Mortality (wt.)/yr. = 8.2652 g/m².

Terminal population wt. = 1.0783 g/m².

Total productivity/yr. = 9.345 g/m².

Total productivity
standing crop = 2.16.

Adequate data for similar computations were available for only a few species that live more than a single year, and results of those computations are given in Table VII.

Similar calculations were attempted for the short-lived amphipod, *Ampelisca* A. In this case the ratio of productivity to standing crop was 9.2 for the summer generation and 3.0 for the winter generation,

but little confidence can be placed in these results, for the sampling intervals were not adequate for valid mortality and growth determinations. Added to this was the difficulty of delineating the summer population, since this group was hatched over a period of a few weeks. Therefore it seemed preferable to obtain an approximation for short-lived species rather than use the above questionable values. Since *Ampelisca* produces two generations a year, and since no individual lives more than a year, it is expected that the relationship of productivity to standing crop is at least twice that obtained for species with annual year-classes. A reasonable estimate of the productivity-standing crop ratio might be about 5, possibly more.

Only the most important species provided sufficient data for analysis, but their dominance accounted for a fairly large percentage of the total biomass of bottom fauna. Of the small infauna, *Nephtys*,

TABLE VII. COMPUTATION RESULTS FOR FOUR LONG-LIVED SPECIES

Species	\bar{M} stand. crop	Term. pop. wt in g	Mortal./year in g	Product. in g	Product. Av. stand. crop
<i>Nephtys incisa</i>	4.3231	1.0783	8.2652	9.3435	2.16
<i>Cistenoides gouldii</i>	0.8763	.0308	1.6697	1.7005	1.94
<i>Pandora gouldiana</i>	3.0803	.0866	6.0466	6.1332	1.99
<i>Yoldia limatula</i>	1.4067	.2022	3.0073	3.2095	2.28

Yoldia and *Cistenoides* constituted 32.0, 6.6, and 6.7% at St. 2; 37.6, 4.7, and 3.3% at St. 3; 32.6, 0.0, and 2.4% at St. 5; 31.8, 19.3, and 11.3% at St. 7; and 39.4, 10.0, and 2.0% at St. 8. At Charles Island, *Pandora* made up 21.5% of the biomass. Together these four species comprised 25.0% of the standing crop at Charles Island, 9.8% at St. 1, 1.0% at St. 4, 35.1% at St. 5, 45.3% at St. 2, 45.7% at St. 3, 51.8% at St. 8, and 62.8% at St. 7. In all of these long-lived species, the productivity value was about 2.1 times that of the standing crop, hence it would seem that application of the same ratio to the remaining long-lived fraction of the biomass would introduce no serious error. This is particularly true of Sts. 2, 3, 7 and 8.

Since the ratio of productivity to standing crop in the short-lived *Ampelisca* was approximately 5, this ratio can be applied similarly to other short-lived infaunal species which produced two generations a year. Species that fall in this category are the amphipods, *Leptocheirus pinguis*, *Unciola irrorata*, *Siphonacetes smithianus*, and various species of *Corophium*. At Charles Island and at Sts. 1, 4, 5, 7, 8, 2 and

3, this short-lived component of the standing crop constitutes 17.2, 34.5, 17.0, 12.7, 3.2, 4.8, 2.6 and 1.9% respectively. The long-lived forms comprise the remaining percentages.

Productivity of the infauna has been determined by using the values 2.1 for long-lived and 5 for short-lived animals, and these results are tabulated in Table VIII. Total productivity varied from 71.64 g/m² at Charles Island to 8.84 g at St. 2, and the average of the means of all eight stations was 29.60 g. The ratio by weight of total productivity to standing crop ranged from 2.17-3.10, with a mean

TABLE VIII. TOTAL PRODUCTIVITY OF INFAUNA OF LESS THAN 0.2 g

Station	\bar{M} stand. crop	-Long-lived component-		-Short-lived component-		Total product.	Product. Stand. crop
		Stand. crop	Product.	Stand. crop	Product.		
Charles Is.	27.576	22.84	2.1 47.966	4.735	5.0 23.675	71.641	2.60
1	3.930	2.576	5.410	1.354	6.770	12.180	3.10
4	25.637	21.289	44.707	4.348	21.740	66.447	2.59
5	9.172	8.006	16.813	1.166	5.830	22.643	2.47
8	10.188	9.695	20.360	0.493	2.465	22.825	2.24
7	10.043	9.690	20.349	0.353	1.765	22.114	2.20
2	4.064	3.959	8.314	0.105	0.525	8.839	2.17
3	4.694	4.605	9.671	0.089	0.445	10.116	2.17
						$\bar{M} = 29.601$	2.44

value of 2.44 (see Table VIII). Although no survey of the sediment composition of Long Island Sound has been undertaken, most of the substrate appears to be made up of fine particles. If we assume that 80% is fine sediment and 20% coarse, the total productivity of the small infauna in the Sound is:

$63.894 [(\bar{M} \text{ of Sts. 2, 3, 7, 8}) \times 4] + 43.228 [(\bar{M} \text{ of Chas. I., Sts. 1, 4, 5}) \times 1] \div 5 = 21.424 \text{ g/m}^2$.

The inadequacy of the basic data does not warrant an estimation of productivity values for the epifauna and total population. However, the mere fact that these animals make up the larger, slower growing forms makes the difference between productivity and standing crop less important.

THE COMMUNITY

Level-Bottom Animal Communities of Long Island Sound. In studying an entirely new area, an investigator with limited time and facilities is faced with the choice of extending his investigation over a wide range of stations or confining his attention to a relatively

few stations. The second alternative, which permitted intensive study of a limited area, seemed to offer a more fruitful approach in this instance. However, since so few localities were sampled, it was difficult to describe and name the level-bottom communities after the manner of Petersen (1913). Although Petersen's nomenclature is not the only source for defining a community, it was adopted nonetheless because of its wide use in marine benthic studies.

At St. 4, where the depth of water is greater than that at most stations, the hard-bottom association showed such characteristic animals as the lamellibranchs, *Astarte undulata* and *Cerastoderma pinnulatum*, and the amphipods, *Leptocheirus pinguis* and *Ampelisca* A. On the other hand, most of the Charles Island samples indicated a shallow water association characterized by the bivalve *Pandora gouldiana* and *Ampelisca* A. Although these may represent communities, it is not feasible to describe them on evidence from only an isolated locality.

Nonetheless, one community did appear to be represented adequately enough to be described. This was the association of animals in the softer sediments which can be characterized by the infauna found at Sts. 2, 3, 7 and 8; possibly St. 5 can be included also, since it may be a transitional area. In this association, which probably represents the typical soft bottom community of the Sound, the biomass was completely dominated by four species which together comprised slightly over 75% of the standing crop. The most important species by weight was the polychaete *Nephtys incisa*, which made up 35.2% of the population and was present in 95% of the samples taken at Sts. 2, 3, 7 and 8. *Nucula proxima*, the next most important member, was represented in every sample and composed 24.4% of the community by weight. Another lamellibranch, *Yoldia limatula*, constituted 10.2% of the biomass and was found in 87.5% of the samples, and *Cistenoides gouldii* was present 87.5% of the time and made up 5.8% of the standing crop. Some of the animals that comprised the remaining 25% of the biomass were: the sea anemone *Cerianthus americanus*; the nemertian *Cerebratulus luridus*; the polychaetes *Melinna cristata*, *Ninoë nigripes*, *Lumbrinereis tenuis* and *Praxillella praetermissa*; the amphipods *Leptocheirus pinguis* and *Siphonacetes smithianus*; the lamellibranchs *Lyonsia hyalina*, *Macoma tenta*, *Mulinia lateralis* and *Pitar morrhuana*; and the gastropod *Lunatia triseriata*, *Retusa caniculatum* and *Cylichna alba*.

It is convenient to classify communities by combining the names of two of the characteristic species, in which case these species should be numerous and should belong to different major groups. In the community under discussion, this limited the characterizing species to the four dominants and hence confined the choice to one of the two polychaetes (*N. incisa* or *C. gouldii*) and to one of the lamellibranchs (*N. proxima* or *Y. limatula*). Since the characterizing species should also be conspicuous, *N. proxima* was eliminated because the vast majority of these lamellibranchs are less than 3 mm in length. *Y. limatula* therefore remained the only choice. *N. incisa* is probably the better polychaete representative, since it was approximately six times more abundant than *C. gouldii* and since, except for St. 2, it made the largest single contribution to the biomass at every station which included this community. Inasmuch as the use of a predatory species should be avoided, this choice may be criticized. However, as shown earlier in this paper, *N. incisa*, at least in the Sound, is a nonselective deposit-feeder.

The concept of parallel communities advanced by Petersen, largely verified since then (see Spärck, 1935), states that two or more geographically separate communities living under similar physical and hydrographic conditions will have essentially similar animal populations, and that the characteristic species will belong to the same genera or, at most, to closely related genera.

Only four of the communities described previously by other investigators might be compared with the soft bottom community of Long Island Sound, the most similar one with regard to environmental factors being the *Syndosmya alba* community originally described from Danish waters (Petersen, 1913); this community, found in shallow and sheltered situations or in estuarine regions of the eastern Atlantic Ocean, Mediterranean and Black Sea, exists on muddy bottoms under conditions of reduced salinity. As implied, the characterizing species is the lamellibranch *Syndosmya alba*. Other common genera in this community are: the lamellibranchs *Cultellus*, *Corbula*, and *Nucula* (two species); the polychaetes *Nephtys* and *Pectinaria* (closely related to *Cistenoides*); and sometimes the echinoderms *Echinocardium* and *Ophiura*.

At somewhat greater depths (20-100 m) of the same geographical areas is the *Amphiura* community. In addition to the echinoderm *Amphiura*, the common genera are: the polychaetes *Nephtys*, *Lum-*

briconereis and *Terebellides*; the scaphopod *Dentalium*; the gastropod *Turritella*; the lamellibranch *Nucula*; and the echinoderms *Brissopsis*, *Echinocardium* and *Schizaster*.

Miyadi (1940) described a *Maldane* community from the muddy sediments of Tanabe-wan, a small Japanese Bay. Here the common genera are the polychaetes *Maldane* and *Telepsavus* and the amphipod *Ampelisca*; the somewhat less common genera are the polychaetes *Magelona*, *Praxillella* and *Glycera*; the lamellibranch *Tellina*; the gastropods *Philine* and *Cylichna*; and the scaphopod *Dentalium*.

Finally, the *Yoldia-hyperborea* community is found in the soft sediments of Icelandic waters at about 10–70 m (Spärck, 1937). The common genera are the polychaetes *Pectinaria*, *Sternaspis*, *Scalibregma*, *Amphicteis*, *Clymenella* and *Maldane*; and the lamellibranchs *Yoldia*, *Nucula* and *Leda*.

While all of these communities have characteristic genera in common with the Long Island Sound community, there are certain notable differences, particularly in regard to the most common genera. In the *Maldane* community, *Nucula* is absent and no other closely related genus is present to replace it. Although *Cistenoides* is replaced by the closely related genus *Pectinaria* in the *Syndosmya*, *Maldane* and *Yoldia-hyperborea* communities, there is no corresponding form in the *Amphiura* community. In the *Maldane* and *Yoldia-hyperborea* communities, *Nephtys* is absent, and only in the *Yoldia-hyperborea* community is the genus *Yoldia* present. Thus, of the four quantitatively dominant genera of the soft bottom community of Long Island Sound, at least one member, or a closely related form, is absent in the four communities discussed. In addition, there is no equivalent in the Sound for *Syndosmya* and *Amphiura*, the characterizing genera of two of these communities, and a third characterizing genus, *Maldane*, is only an insignificant member of the Sound community.

Obviously, then, it is extremely difficult to equate the Long Island Sound community to any of the four communities discussed. It is proposed, therefore, that this association of animals in Long Island Sound be called the *Nephtys incisa*-*Yoldia limatula* community, which is confined to sediments containing more than 25% silt and clay at depths of from 4 to at least 30 m with bottom temperatures of 0.5–22° C and salinities of at least 24.7–29.2‰.⁶

⁶ On July 26, 1955 the author found this community entirely intact in Buzzards Bay near Woods Hole, Mass. (Lat. 41° 32.4' N, Long. 70° 43.9' W) in about 15 m of water; but the maximum salinity in this area is about 32‰.

The Relationship of Primary Feeding Types to Sediment Composition. In the remaining pages of this section an attempt will be made to see whether or not the primary feeding types (herbivores and detritus feeders) have any quantitative relationships to the character of the sediment. Information on feeding has been obtained largely from Blegvad (1914), Hunt (1926), Remane (1933), Thamdrup (1935) and Mare (1942), and, somewhat after the manner of Hunt (1926), these animals have been divided into three broad categories.

1. *Suspension feeders*, which live on organic matter suspended in the water, include: lamellibranchs with short separate siphons, namely *Pandora*, *Mulinia*, *Astarte*, *Lyonsia*, *Anadara*, *Cerastoderma*, *Pitar*, *Mercenaria* and *Ensis*; certain gastropods of the genus *Crepidula*; the filter-feeding amphipods *Ampelisca*, *Leptocheirus* and *Corophium*; the serpulid polychaete *Hydroides*; and the dendrochirote holothurian *Thyone*.

2. *Selective deposit-feeders*, which feed discriminantly either on or in the sediment, include both detritus feeders and herbivores; in this group are: lamellibranchs with long free siphons such as *Macoma*; lamellibranchs with prehensile labial palps, *Nucula* and *Yoldia*; polychaetes of the families Ampharetidae (*Ampharete* and *Melinna*), Terebellidae (*Pista* and *Trichobranchius*), Amphictenidae (*Cistenoides*), Chlorhaemidae (*Flabelligera*), and Cirratulidae (*Cirratulus* and *Polycirrus*); such amphipods as *Unciola*, *Siphonacetes*, *Stenothoë*, *Amphithoë* and *Erichthonius*; the cumaceans *Diastylis* and *Oxyurostylis*; the tanaid *Leptognathia*; the isopods *Edotea* and *Chiridotea*; and possibly the tectibranch molluscs *Retusa*, *Cylichna* and *Acteon* (Berrill, 1931).

3. *Nonselective deposit-feeders*, which indiscriminantly ingest the sediment, include: the polychaete families Ophelidae (*Ophelia*), Maldanidae (*Maldane*, *Clymenella*, *Praxillella* and *Rhodine*), Ariciidae (*Aricidia*), Scalibraemidae (*Scalibregma*) and, as shown earlier, the species *Nephtys incisa*.

Within two of the feeding types, the mechanisms vary widely. For example, among the suspension feeders, the gills act as a selective filter in the lamellibranchs while the mouthparts or certain leg appendages perform this function in the amphipods. Among selective deposit-feeders, the protobranchiate lamellibranchs use prehensile labial palps to obtain their food, other lamellibranchs probe over the bottom with long separate siphons (Yonge, 1939; 1949), and the poly-

chaetes feed by means of prehensile tentacles. In the following discussion of the general relationship of feeding types to sediment, it should be borne in mind that, in view of the different feeding habits of different animals, this relationship will be less precise than that determined for an individual species.

The dry weights of the three feeding types are shown in Fig. 23, where the stations are arranged in the order of increasing silt-clay content of their sediments. What is plotted, then, is the relationship between feeding type and sediment composition, and it is clear from Fig. 23 that such a relationship does exist. This is particularly evident in regard to suspension feeders. At stations characterized by little silt and clay, the suspension feeders completely dominated, while at stations with sediments of high silt-clay concentrations they constituted an insignificant standing crop. These results, then, support the contention made earlier in this paper that coarser sediments indicate favorable environmental conditions for suspension feeders. Since there is little net deposit of fine sediment in such environments, there are probably more pronounced bottom currents; hence more water and more food are made available to these organisms in a unit period of time. In this connection, Smith (1932) found in the typical gravel bottom of the Eddystone grounds near Plymouth that the largest number of species were suspension feeders, but he attempted no quantitative evaluation.

Results of an analysis of the nonselective deposit-feeders indicate that three different situations exist. At high concentrations of silt and clay (> 50%), as typified by Sts. 2 and 3, there were low biomass values. Between concentrations of approximately 25-50% silt-clay (Sts. 5, 8 and 7), high values were obtained. At somewhat lower concentrations (Charles Island and Sts. 1 and 4), nonselective deposit-feeders were poorly represented, particularly at Sts. 1 and 4, where the coarsest sediments were found. This distribution pattern can be interpreted to mean that coarse sediments with low concentrations of silt and clay are unfavorable because the hard substrate is not only unsatisfactory for burrowing but contains only a relatively small amount of organic matter which in turn can support only a small biomass of nonselective deposit-feeders. At the other extreme, when there are extremely high concentrations of silt and clay, the large quantity of organic matter provides a high food potential, but in this instance conditions become unfavorable due to lack of oxygen.

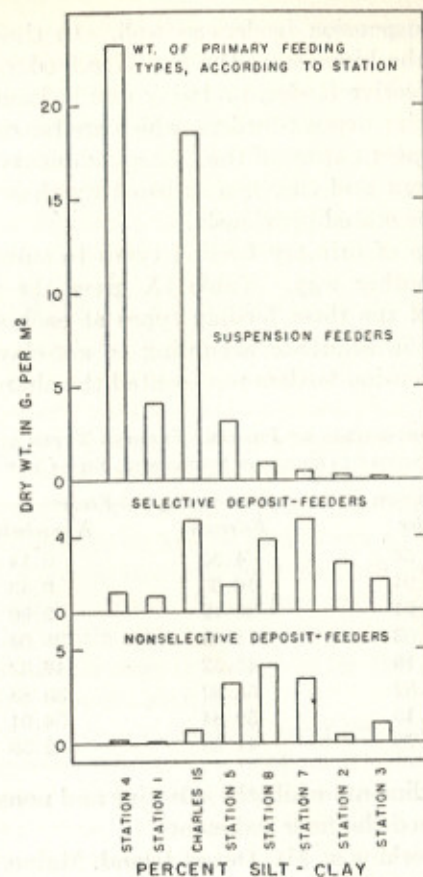

Figure 23. Weight of primary feeding types by station.

The histogram patterns for both selective and nonselective deposit-feeders are essentially similar at all stations except for that of Charles Island, where the higher biomass for the selective deposit-feeder was almost entirely due to the sample of October 23, 1953, which contained an abnormally high silt-clay concentration for that station. The poor representation of both selective and nonselective feeding types on the coarser sediments was directly related to low concentrations of settled detritus and to the small quantity of organic matter in the sediment; at high silt-clay concentrations it was the low oxygen content which created the unfavorable environment for these two

groups, and for suspension feeders as well. In these same environments, however, the biomass of the selective feeder was higher than that of the nonselective feeder, probably due in large measure to the fact that nonselective deposit-feeders, which are burrowers exclusively, find the hard compact nature of the coarse sediments and the reduced sediment of high silt and clay less satisfactory than selective feeders for obvious reasons stated previously.

The relationship of primary feeding types to substrates is demonstrable in still another way. Table IX gives the percentage composition of each of the three feeding types at each station, with the stations arranged in sequence according to silt-clay content. It is seen that the suspension feeders represented the characteristic feeding

TABLE IX. COMPOSITION OF PRIMARY FEEDING TYPES AT EACH STATION. STATIONS ARRANGED IN ORDER OF INCREASING SILT-CLAY PERCENTAGE.

Station	Suspension feeder	Deposit-Feeder		% silt-clay
		Selective	Nonselective	
4	95.56%	4.30	0.14	5.4
1	82.94	16.63	0.43	4.7
Charles Is.	76.91	20.19	2.90	11.0
5	43.03	18.93	38.04	18.5
8	10.16	43.52	46.32	28.0
7	5.82	55.82	38.88	31.5
2	6.15	59.84	34.01	56.0
3	5.78	41.68	52.39	65.0

type on coarser sediments while the selective and nonselective deposit-feeders characterized the finer sediments.

Bader (1954), working at Mt. Desert Island, Maine, found a positive correlation between the density of the lamellibranch population and the organic content of the sediment, with population density falling off sharply at concentrations of organic matter above 3%. He stated:

The pelecypod population, as used in this discussion, refers to the total density of pelecypods, including all species. This procedure was followed because the species of pelecypods which are abundant enough to consider individually show the same general trends as the total pelecypod population. The investigation did not show any major ecological hiatus to the exclusion of one or more species.

Actually, nine of the 16 species of lamellibranchs examined by Bader are suspension feeders, and for these Bader has assumed that

organic matter in the sediment is the prime source of food. This assumption seems extremely doubtful, since the correlation between suspension feeders and sediment type results from the relation between water circulation immediately over the bottom (of paramount importance to suspension feeders) and the type of sediment found. Hence the sediment content is of importance to suspension feeders, not *per se* but as an indication of other physical conditions.

SUMMARY AND CONCLUSIONS

(1) A bottom survey of a limited area of Long Island Sound was carried out from August 1953 to September 1954, but in some instances additional data, obtained subsequently, have also been used. Most of the eight stations were worked at frequent intervals.

(2) The dry weight of each species in each sample was obtained separately. Individuals of the numerically abundant species were divided into size categories by length, and, when an adequate number of individuals of a given size category had accumulated, the dry weight was determined. From this figure the mean weight of the individual animals within this size range was computed. Tables relating length to weight were constructed for the dominant species on the basis of these computations.

(3) Modification of the techniques used by soil scientists was adopted for sediment analysis. In contrast to data given in other bottom investigations, significantly higher concentrations of silt and clay were obtained from all types of sediments. Results indicate that large fractions of these components are lost when the more commonly employed procedures are used. Since the clay component is closely associated with organic matter in sediments, the desirability of its precise determination is evident.

(4) Within a single station there were significant variations among different samples when the total biomass was considered, but when the larger, less abundant animals were excluded, the variability was significantly reduced. Still further uniformity was achieved when only the infaunal component of each sample was compared.

(5) It was possible to characterize the infauna of each sediment by a narrow range of biomass values. This was true not only between stations but even when samples from the same stations came from different sediment types.

(6) Results of the present investigation have shown that a close relationship exists between the silt-clay concentrations of the sediment and the size of the infaunal population. The largest populations were found in sediments containing 13-25% silt and clay. Deviation from this range either towards higher or lower concentrations gave progressively smaller biomass values.

(7) The animals under a square meter of bottom varied from 5,563 at St. 5 to 46,398 at Charles Island.

(8) The weight of all small organisms (those less than 0.2 g dry weight) varied from 4.54 g at St. 2 to 36.38 g/m² at Charles Island. Considering only the infauna, the values ranged from 3.93 g at St. 1 to 27.57 g at Charles Island.

(9) Long Island Sound supported a larger benthic population in both numbers and weight than that found in other areas by previous workers.

(10) Two mechanisms, the extensive freshwater drainage and the two-layer transport exchange, maintain high concentrations of nutrients in the Sound. These in turn allow dense concentrations of phytoplankton to develop, so that the ratio of phytoplankton to zooplankton is larger than that found for certain other inshore waters. This implies that the zooplankton is utilizing a smaller fraction of the available phytoplankton, leaving a larger proportion for other utilization. Since bacterial decomposition in this shallow water column must be limited, large quantities of phytoplankton are made available to benthic animals. This large supply of organic matter is the most obvious explanation for the high benthic biomass in the Sound.

(11) Detailed examination of the ecological relationships of the most dominant species was made:

a) The polychaete *Nephtys incisa* comprised approximately one-third of the biomass of smaller animals at stations with softer sediments and with maximal values within the 25 to 37% silt-clay range. Despite statements in the literature, *Nephtys incisa*, at least in Long Island Sound, must be considered a nonselective deposit-feeder rather than a carnivore. Trophic considerations and stomach analyses support this view.

b) The trumpet worm, *Cistenoides gouldii*, constituted almost 6% of the smaller animals at stations with finer sediments. The animal is a selective deposit-feeder and is found in largest numbers in sedi-

ments containing 20 to 40% silt and clay. Its mode of feeding prevents this organism from being abundant in sediments with either low or high concentrations of silt and clay.

c) The two most abundant forms of the amphipod genus *Ampelisca* are so similar that it was deemed unwise to attempt to separate them taxonomically. *Ampelisca* A, confined at all times of the year to the coarser sediments and comprising 14% of the infaunal populations, was 3-4 times heavier than its counterpart, *Ampelisca* B, which occurred only in the finer sediments and which made up 2% of their populations. The absence of overlap in their ranges suggests intense competition between them. Within the range of each form, no significant difference in size occurred, which indicates that this difference is of genetic rather than environmental origin. Each of these filter-feeding forms has a short summer and a long overwintering generation. Females were 15 times more common than males in both *Ampelisca* A and B; on closer examination, however, half of the females proved to be gynomorphic males.

d) The lamellibranch, *Yoldia limatula*, comprised almost 10% of the infauna of the softer sediments with maximal values in 30 to 45% silt-clay.

e) The lamellibranch *Nucula proxima*, despite its small size, constituted 24% of the infaunal biomass of the finer sediments. Substantial populations were found in sediments containing 35 to 75% silt-clay, thus indicating that this animal can tolerate somewhat reduced concentrations of oxygen. Like *Y. limatula*, *N. proxima* feeds by means of palp proboscides and is considered a selective deposit-feeder.

f) *Pandora gouldiana*, though found at all eight stations, made up a large fraction of the biomass at only Charles Island, where it comprised 14% of the infauna. Apparently this suspension-feeding lamellibranch is largely limited to sediments low in silt-clay and gravel.

(12) For present purposes, the productivity of a species or community, defined as the amount of organic matter produced in the course of a year, is estimated indirectly from calculations on growth, mortality and recruitment. Productivity values were obtained for four long-lived species: *Nephtys incisa*, *Cistenoides gouldii*, *Yoldia limatula* and *Pandora gouldiana*. Since the ratio of annual productivity to biomass for these species varied from 1.94-2.28, with a mean

value of 2.1, and since this value was based on forms that constituted more than 50% of the infauna of softer sediments, it seemed reasonable to use the same factor (2.1) to determine the productivity of the remaining long-lived animals in the population. A larger ratio of productivity to standing crop was indicated for short-lived animals; 5.0 appeared to be the most reasonable figure.

Using the determined amounts of long-lived and short-lived animals together with the above ratios, the factor obtained for the infauna ranged from 2.17 at Sts. 2 and 3 to 3.10 at St. 1; for all stations the ratio was 2.44.

(13) Consideration of the relationship between primary feeding types and sediment composition showed clearly that suspension feeders represented the characteristic feeding type on coarser sediments, where they comprised more than 80% of the total for the three feeding groups; in fine sediments they constituted only 6%. Conversely, in the finer substrates the selective and nonselective deposit-feeders were the dominant forms whereas in coarser sediments they represented only minor constituents of the population.

(14) Finally, an attempt was made to classify the level bottom communities, only one of which was represented adequately at the stations sampled. This was the population that inhabited the softer sediments at Sts. 2, 3, 7 and 8. Since significant differences were found between the composition of the dominant species of this community and that of similar ones from other regions of the world, it is proposed that this association of animals be called the *Nephtys incisa-Yoldia limatula* community of Long Island Sound, which is confined to sediments containing more than 25% silt and clay and which exists at depths of 4-30 m at temperatures of 0.5-22° C and at salinities of at least 24.7-29.2‰.

REFERENCES

- ALLEN, J. A.
1953. Observations on *Nucula turgida* Marshall and *N. Moorei* Winckworth. J. Mar. biol. Ass. U. K., N. S. 31 (3): 515-527.
1954a. A comparative study of the British species of *Nucula* and *Nuculana*. J. Mar. biol. Ass. U. K., N. S. 33 (2): 457-472.
1954b. On the structure and adaptation of *Pandora inaequalis* and *Pandora pinna*. Quart. J. micr. Sci., 95 (4): 473-482.
- BADER, R. G.
1954. The role of organic matter in determining the distribution of pelecypods in marine sediments. J. Mar. Res., 13 (1): 32-47.
- 1956] Sanders: X. Biology of Marine Bottom Communities 407
- BARNARD, J. L.
1954. Amphipoda of the family Ampeliscidae collected in the eastern Pacific Ocean by the Velero III and Velero IV. Allan Hancock Pacific Exped., 18 (1): 1-137.
- BEANLAND, F. L.
1940. Sand and mud communities in the Dovey Estuary. J. Mar. biol. Ass. U. K., N. S. 24: 589-611.
- BERRILL, N. J.
1931. The natural history of *Bulla hydatis* Linne. J. Mar. biol. Ass. U. K., N. S. 17 (2): 567-571.
- BLEGGVAD, H.
1914. Food and conditions of nourishment among the communities of invertebrate animals found on or in the sea bottom in Danish waters. Rep. Danish biol. Sta., 22: 41-78.
1928. Quantitative investigations of bottom invertebrates in the Limfjord, 1910-1927, with special reference to the plaice-food. Rep. Danish biol. Sta., 34: 33-52.
1951. Fluctuations in the amount of food animals of the bottom of the Limfjord in 1928-1950. Rep. Danish biol. Sta., 53: 3-16.
- BOUYOUKOS, G. J.
1936. Directions for making mechanical analyses of soils by the hydrometer method. Soil Sci., 42: 225-229.
- CRAWFORD, G. I.
1937. Notes on the distribution of burrowing Isopoda and Amphipoda in various soils on the sea-bottom near Plymouth. J. Mar. biol. Ass. U. K., N. S. 21: 631-646.
- DREW, G. A.
1899. Some observations on the habits, anatomy and embryology of members of the Prosobranchia. Anat. Anz., 15: 493-519.
- FORSTER, G. R.
1953. A new dredge for collecting burrowing animals. J. Mar. biol. Ass. U. K., N. S. 32 (1): 193-198.
- FRASER, J. H.
1932. Observations on the fauna of an estuarine mud in a polluted area. J. Mar. biol. Ass. U. K., N. S. 18: 69-85.
- HOLME, N. A.
1949. The fauna of sand and mud banks near the mouth of the Exe. J. Mar. biol. Ass. U. K., N. S. 28 (1): 189-237.
1953. The biomass of the bottom fauna in the English Channel off Plymouth. J. Mar. biol. Ass. U. K., N. S. 32 (1): 1-49.
- HOLMES, S. J.
1903. Synopsis of North American invertebrates. 18. The Amphipoda. Amer. Nat., 37: 267-292.
- HUNT, O. D.
1926. The food of the bottom fauna of the Plymouth fishing grounds. J. Mar. biol. Ass. U. K., N. S. 13: 560-599.

- JENSEN, P. B.
1919. Valuation of the Limfjord. I. Studies on the fish food in the Limfjord, 1909-1917, its quantity, variation, and annual production. Rep. Danish biol. Sta., 26: 3-44.
- KUNKEL, B. W.
1918. The Arthrostraca of Connecticut. Bull. Conn. geol. nat. Hist. Surv., 26: 1-261.
- LEE, R. E.
1944. A quantitative survey of the invertebrate bottom fauna in Menemsha Bight. Biol. Bull. Woods Hole, 56 (2): 83-97.
- LINDEMANN, R. L.
1942. The trophic-dynamic aspect of ecology. Ecology, 23: 399-418.
- MARE, M. F.
1942. A study of a marine benthic community with special reference to the microorganisms. J. Mar. biol. Ass. U. K., N. S. 25: 517-554.
- MIYADI, D.
1940. Marine benthic communities of the Tanabe-wan. Annot. zool. jap., 19 (2): 136-148.
1941. Indentation individuality in the Tanabe-wan. Mem. imp. Mar. Obs. Kobe, 7 (4): 471-482.
1941a. Marine benthic communities of the Beppu-wan. Mem. imp. Mar. Obs. Kobe, 7 (4): 483-502.
- MOORE, H. B.
1931. The muds of the Clyde area. III. Chemical and physical conditions; rate and nature of sedimentation and fauna. J. Mar. biol. Ass. U. K., N. S. 17: 325-358.
- PARK, T., G. L. CLARKE, R. W. PENNAK, W. T. EDMONDSON, and W. E. RICKER
1946. Dynamics of production in aquatic populations. Ecol. Monogr., 16 (4): 311-391.
- PETERSEN, C. G. J.
1913. Valuation of the sea. II. The animal communities of the sea bottom and their importance for marine zoogeography. Rep. Danish biol. Sta., 21: 110 pp.
1918. The sea bottom and its production of fish food. Rep. Danish biol. Sta., 25: 1-62.
- PETERSEN, C. G. J., and P. BOYSEN JENSEN
1911. Valuation of the sea. I. Animal life on the sea bottom, its food and quantity. Rep. Danish biol. Sta., 20: 3-79.
- RAYMONT, J. E. G.
1949. Further observations on changes in the bottom fauna of a fertilized sea loch. J. Mar. biol. Ass. U. K., N. S. 28 (1): 9-19.
- REID, D. M.
1951. Report on the Amphipoda (Gammaridea and Caprellidea) of the coast of tropical West Africa. Atlantide Rep. No. 2. Sci. Res. Danish Exped. to trop. W. Africa, 1945-1946: 189-291.
- 1956] Sanders: X. Biology of Marine Bottom Communities 409
- REMANE, A.
1933. Verteilung und Organisation der benthonischen Mikrofauna der Kieler Bucht. Wiss. Meeresuntersuch., N. F., 21 Bd., Abt. Kiel, Heft 2: 161-222.
- RILEY, G. A., HENRY STOMMEL, and D. F. BUMPUS
1949. Quantitative ecology of the plankton of the western North Atlantic. Bull. Bingham oceanogr. Coll., 12 (3): 1-169.
- RUSSELL, E. J.
1950. Soil conditions and plant growth. Longmans, Green and Co., New York. 635 pp.
- SANDERS, H. L.
1955. The Cephalocarida, a new subclass of Crustacea from Long Island Sound. Proc. nat. Acad. Sci., 41 (1): 61-66.
- SMIDT, E.
1951. Animal production in the Waddensea. Medd. Komm. Havundersøg. Kbn., Fiskeri, 11 (6): 1-151.
- SMITH, J. E.
1932. The shell gravel deposits and infauna of the Eddystone grounds. J. Mar. biol. Ass. U. K., N. S. 18: 243-278.
- SOIL SURVEY STAFF
1951. Soil Survey Manual, U. S. Dept. Agr. Handbook No. 18: 1-503.
- SPÄRCK, T.
1935. On the importance of quantitative investigation of the bottom fauna in marine biology. J. Cons. int. Explor. Mer., 10: 3-19.
1937. The benthonic animal communities of the coastal waters. Zoology of Iceland, 1 (6): 1-45. Copenhagen and Reykjavik.
- THAMDRUP, H. M.
1935. Beiträge Zur Ökologie der Wattenfauna. Medd. Komm. Havundersøg. Kbn., Fiskeri, 10 (2): 1-125.
- THORSON, G.
1936. The larval development, growth and metabolism of Arctic bottom invertebrates. Medd. Grønland, 100: 1-155.
- WATSON, A. T.
1927. Observations on the habits and life-history of *Pectinaria (Lagis) Koreni*. Proc. Lpool. biol. Soc., 42: 25-59.
- YONGE, C. M.
1939. The protobranchiate mollusca; a functional interpretation of their structure and evolution. Philos. Trans., B 230: 79-147.
1949. On the structure and adaptations of the Tellinacea, deposit feeding Eulamellibranchia. Philos. Trans., B 234: 29-76.
1952. Structure and adaptation in *Entodesma saxicola* (Baird) and *Mytilimeria Nuttallii* Conrad. Univ. Cal. Publ. Zool., 55 (10): 439-450.

APPENDIX I. LENGTH-WEIGHT RELATIONSHIPS OF SOME DOMINANT SPECIES IN LONG ISLAND SOUND.

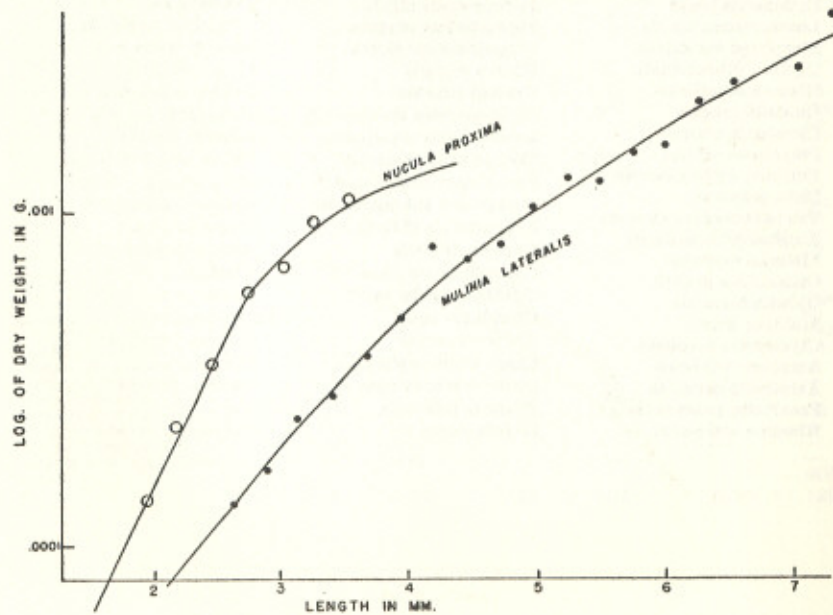
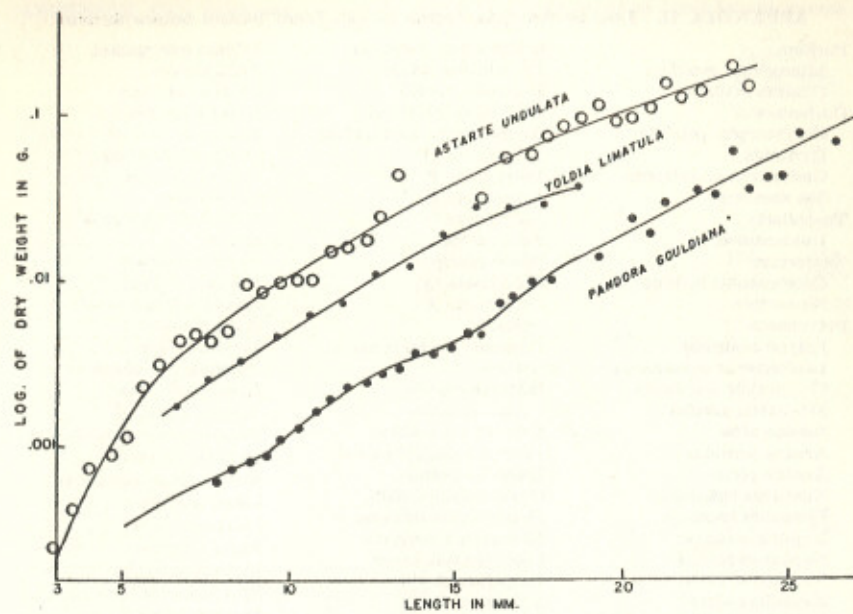
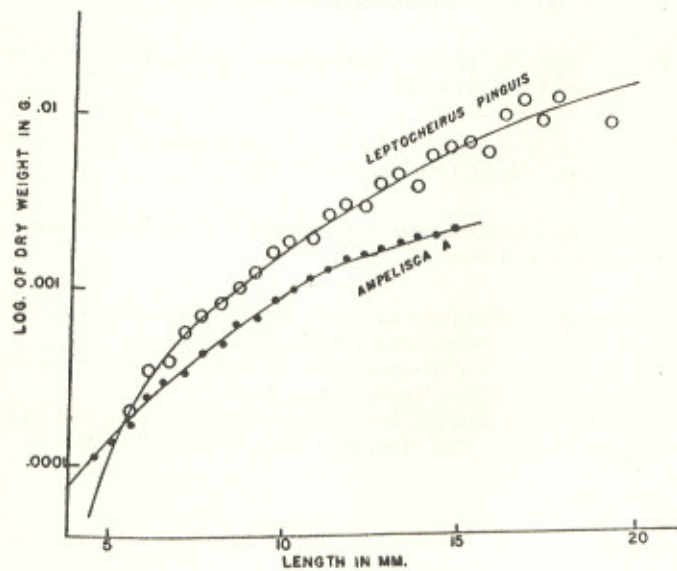
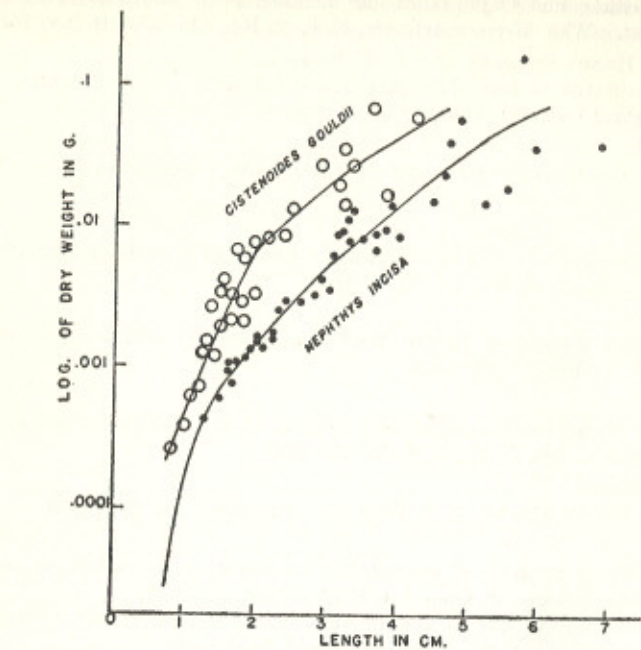

APPENDIX II. LIST OF ANIMALS FOUND IN THE LONG ISLAND SOUND SURVEY

Porifera	Scalibregma infatum	Libinia emarginata
Microciona prolifera	Flabelligera affinis	Pelia mutica
Chalina oculata	Potamilla torelli	Pinnixia sayana
Coelenterata	Hydroides dianthus	Neopanope texana
Corymorpha pendula	Ancistrosyllis tentaculata	Panopeus herbstii
Hydroids	Polychaete D	Ovalipes ocellatus
Cerianthus americanus	Polychaete E	Cancer irrorata
Sea anemone	Polychaete F	Pycnogonida
Turbellaria	Polychaete G	Nymphon grossipes
Unidentified sp.	Aricidia sp.	Mollusca
Nemertina	Ninoë nigripes	Nucula proxima
Cerebratulus luridus	Polychaete Q	Yoldia limatula
Nemertine	Polychaete X	Anadara transversa
Polychaeta	Splonid	Anomia simplex
Polyoë acanellae	Unidentified polychaete	Mytilus edulis
Lepidonotus squamatus	Crustacea	Pandora gouldiana
Harmothoe imbricata	Hutchinsoniella	Lyonsia hyalina
Sthenelais gracilis	macracantha	Astarte undulata
Eteone alba	Balanus balanoides	Cerastoderma pinnatum
Anaitis formosa	Diastylis quadrispinosa	Pitar morrhuana
Anaitis picta	Diastylis polita	Mercenaria mercenaria
Anaitides catenula	Oxyurostylis smithi	Gemma gemma
Neanthes succinea	Heteromysis formosa	Macoma tenta
Nephtys incisa	Neomysis americana	Ensis directus
Nephtys ingens	Leptognathia caeca	Mulinia lateralis
Nephtys caeca	Ampelisca A	Mya arenaria
Nephtys picta	Ampelisca B	Lunatia heros
Arabella iricolor	Stenothoe cypris	Lunatia triseriata
Diopatra cuprea	Elasmopus levis	Polinices duplicatus
Drilonereis longa	Podoceropepsis nitida	Leptocheirus pinguis
Lumbrineris tenuis	Leptocheirus pinguis	Crepidula convexa
Marphysa sanguinea	Amphithoe rubricata	Crepidula plana
Glycera dibranchiata	Grubia compta	Eupleura caudata
Glycera americana	Unciola irrorata	Urosalpinx cinerea
Goniada gracilis	Siphonacetes smithianus	Mitrella lunata
Cirratulus grandis	Erichthonius brasiliensis	Nassarius triviattatus
Polycirrus eximus	Corophium acherusicum	Busycon canaliculatum
Polycirrus phosphoreus	Corophium crassicornae	Retusa canaliculatum
Pista palmata	Corophium tuberculatum	Cylichna alba
Trichobranchius glacialis	Aeginella longicornis	Acteon punctostriatus
Ampharete acutifrons	Caprella linearis	Turridae
Melinna oristata	Caprella geometrica	Elysia catula
Cistenoides gouldii	Cyathura carinata	Echinodermata
Ophelia limacina	Chiridotea tuftii	Thyone briareus
Maldane sarsi	Edotea montosa	Holothurian
Clymenella torquata	Crago septemspinus	Asterias forbesi
Amphicora fabricii	Pagurus longicarpus	Pisces
Axiothella catenata	Pagurus pollicaris	Gobius sp.
Praxillella praetermissa	Libinia dubia	
Rhodine attenuata		

APPENDIX III. ANALYSES OF SOME REPRESENTATIVE STATIONS IN LONG ISLAND SOUND. NUMBERS AND WEIGHTS PER M²

Species	W. of Charles I.		Station 1		Station 4	
	Dec. 23, 1953		April 19, 1954		Feb. 19, 1954	
	No.	Wt.	No.	Wt.	No.	Wt.
Hydroids	+	1.31	+	12.89	+	.64
Polyoë acanellae	—	.24	—	—	—	—
Lepidonotus squamatus	—	.068	68	.38	—	—
Sthenelais gracilis	1558	.062	—	—	—	—
Eteone alba	—	.0015	—	.25	—	—
Neanthes succinea	—	.0015	281	.25	—	—
Nephtys incisa	—	—	91	.037	15	.046
Nephtys ingens	—	.028	—	—	—	—
Nephtys caeca	—	—	236	.033	106	.016
Nephtys picta	—	—	—	—	8	.0046
Diopatra cuprea	15	.096	—	—	—	—
Lumbrineris tenuis	—	—	—	—	8	.0023
Glycera dibranchiata	23	.12	—	—	—	—
Glycera americana	—	—	30	.068	—	—
Goniada gracilis	8	.0053	—	—	—	—
Trichobranchius glacialis	8	.029	—	—	—	—
Ampharetes acutifrons	8	.011	236	.22	106	.14
Cistenoides gouldii	15	.14	—	—	8	.0015
Flabelligera affinis	8	.013	—	—	—	—
Hydroides dianthus	—	—	61	.44	—	—
Unidentified polychaete	61	.079	—	—	—	—
Oxyurostylis smithi	8	.0023	—	—	—	—
Neomysis americana	—	—	190	.13	—	—
Leptognathia caeca	—	—	—	—	20284	.32
Ampelisca A	616	.32	1307	1.50	1885	.96
Stenothoe cypris	—	—	699	.052	684	.052
Podoceropepsis nitida	—	—	46	.0091	—	—
Leptocheirus pinguis	—	—	—	—	312	.95
Grubia compta	23	.012	—	—	—	—
Amphithoe rubricata	122	.062	—	—	—	—
Unciola irrorata	61	.21	91	.31	84	.13
Erichthonius brasiliensis	122	.0061	471	.047	213	.026
Corophium acherusicum	935	.050	1543	.089	—	—
Corophium crassicornae	—	—	—	—	471	.10
Aeginella longicornis	—	—	23	.0038	—	—
Edotea montosa	433	.17	23	.0084	—	—
Crago septemspinus	38	1.28	91	4.98	—	—
Pagurus longicarpus	15	.057	84	2.37	160	3.61
Pagurus pollicaris	8	13.79	53	124.79	—	—
Libinia emarginata	8	.050	—	—	15	2.32
Pelia mutica	—	—	8	.061	8	.036
Pinnixia sayana	—	—	—	—	53	.52
Neopanope texana	84	1.19	68	1.77	—	—
Panopeus herbstii	—	—	144	5.78	—	—
Nucula proxima	8	.0023	8	.0053	—	—
Anadara transversa	15	.078	—	—	106	.19
Pandora gouldiana	502	2.19	—	—	53	.031
Lyonsia hyalina	15	.20	—	—	76	.25
Astarte undulata	—	—	—	—	3580	18.64
Cerastoderma pinnatum	—	—	—	—	84	.67
Mercenaria mercenaria	46	.036	—	—	—	—
Gemma gemma	122	.012	—	—	—	—
Macoma tenta	3177	3.43	—	—	53	.089
Ensis directus	8	.23	—	—	53	.59
Mulinia lateralis	1041	.41	471	.12	8	.0046
Lunatia triseriata	—	—	—	—	8	.19
Crepidula plana	23	.028	334	.29	—	—
Eupleura caudata	8	.0053	46	.95	—	—
Mitrella lunata	—	—	8	.0023	—	—
Nassarius triviattatus	38	1.21	23	.28	23	.59
Busycon canaliculatum	8	.40	—	—	—	—
Retusa canaliculatum	3238	.70	—	—	—	—
Acteon punctostriatus	745	.050	8	.0008	—	—
Turridae	—	—	—	—	8	.0068
Totals	13203	28.3838	6742	157.8667	28472	31.1258

APPENDIX III—Continued

Species	Station 5 Feb. 19, 1954		Station 8 Feb. 3, 1954		Station 3 Feb. 19, 1954	
	No.	Wt.	No.	Wt.	No.	Wt.
Corymorpha pendula	46	.45	—	—	—	—
Hydroids	+	.41	—	—	—	—
Cerianthus americanus	61	.64	—	—	—	—
Eteone alba	—	—	46	.0046	30	.14
Anaitides catenula	8	.0030	—	—	—	—
Nephtys incisa	996	5.69	1429	3.99	106	.54
Nephtys caeca	—	—	137	.022	—	—
Diopatra cuprea	53	.20	—	—	—	—
Lumbrineris tenuis	15	.012	—	—	23	.028
Glycera dibranchiata	—	—	8	.052	—	—
Trichobranchius glacialis	—	—	46	.022	—	—
Melinna cristata	53	.052	357	.18	—	—
Cistenoides gouldii	213	.074	182	.13	15	.014
Maldane sarsi	15	.059	8	.055	—	—
Flabelligera affinis	23	.35	—	—	—	—
Spinoid	—	—	8	.0015	—	—
Unidentified polychaete	frag.	.086	182	.0091	213	.021
Ampelisca B	1360	.11	—	—	46	.0046
Stenothoe cypris	524	.042	—	—	—	—
Leptocheirus pinguis	38	.14	46	.054	—	—
Unciola irrorata	365	.17	—	—	—	—
Siphonacetes smithianus	160	.026	—	—	—	—
Panopeus herbstii	15	.76	—	—	—	—
Nymphon grossipes	8	.0008	—	—	—	—
Nucula proxima	8	.0023	8003	1.27	1984	.31
Yoldia limatula	—	—	137	.67	61	.32
Anadara transversa	8	.072	—	—	—	—
Pandora gouldiana	53	.011	23	.081	8	.0076
Lyonsia hyalina	258	.85	—	—	—	—
Pitar morrhua	160	.47	15	.0030	8	.0015
Macoma tenta	—	—	8	.0038	8	.0023
Mulinia lateralis	524	.14	8	.0015	—	—
Lunatia triseriata	—	—	15	.58	—	—
Polinices duplicatus	8	.60	—	—	—	—
Urosalpinx cinerea	—	—	8	.023	—	—
Retusa canaliculatum	—	—	2098	.42	167	.030
Cylichna alba	106	.021	1026	.21	—	—
Acteon punctostriatus	8	.0084	8	.0008	—	—
Turridae	312	.043	91	.031	—	—
Totals	5398	11.4925	13889	7.8143	2669	1.4190

PUBLICATIONS ISSUED BY THE BINGHAM OCEANOGRAPHIC LABORATORY

OCCASIONAL PAPERS OF THE BINGHAM OCEANOGRAPHIC COLLECTION

- NUMBER 1. A contribution to the theoretical analysis of the schooling behavior of fishes. By A. E. Parr (out of print)..... pp. 1- 32 \$.50
- NUMBER 2. A contribution to the osteology and classification of the orders Iniomi and Xenoberycees. By A. E. Parr (out of print)..... pp. 1- 45 \$.65
- NUMBER 3. On the osteology and classification of the pediculate fishes of the genera Aceratias, Rhynchoceratias, Haplophryne, Laevoceratias, Allector and Lipactis. By A. E. Parr (out of print)..... pp. 1- 23 \$.35

BULLETIN OF THE BINGHAM OCEANOGRAPHIC COLLECTION

- VOLUME I. *Scientific results of the first oceanographic expedition of the "Pawnee," 1925. (Complete.)*
 - ARTICLE 1. Fishes. By C. M. Breder, Jr. (out of print)..... pp. 1- 90 \$1.35
 - ARTICLE 2. Crustacea from tropical East American Seas. By Lee Boone (out of print)..... pp. 1-147 \$2.20
 - ARTICLE 3. Mollusca from tropical East American Seas. By Lee Boone (out of print)..... pp. 1- 20 \$.30
 - ARTICLE 4. Echinodermata from tropical East American Seas. By Lee Boone (out of print)..... pp. 1- 22 \$.35
 - ARTICLE 5. Coelenterata from tropical East American Seas. By Lee Boone (out of print)..... pp. 1- 8 \$.10
- VOLUME II. *Scientific results of the second oceanographic expedition of the "Pawnee," 1926. (Complete.)*
 - ARTICLE 1. Elasmobranchii from Panama to Lower California. By C. M. Breder, Jr. (out of print)..... pp. 1- 13 \$.20
 - ARTICLE 2. Nematognathi, Apodes, Isospondyli, Syntognathi, and Thoracostraci from Panama to Lower California. By C. M. Breder, Jr. (out of print)..... pp. 1- 25 \$.40
 - ARTICLE 3. Heterosomata to Pediculati from Panama to Lower California. By C. M. Breder, Jr. (out of print)..... pp. 1- 56 \$.85
 - ARTICLE 4. Deepsea fishes from off the western coast of North and Central America. By A. E. Parr (out of print)..... pp. 1- 53 \$.80
 - ARTICLE 5. Mollusks from the Gulf of California and the Perlas Islands. By Lee Boone (out of print)..... pp. 1- 17 \$.25
 - ARTICLE 6. Echinoderms from the Gulf of California and the Perlas Islands. By Lee Boone (out of print)..... pp. 1- 14 \$.20
- VOLUME III. *Scientific results of the third oceanographic expedition of the "Pawnee," 1927. (Complete.)*
 - ARTICLE 1. Ceratioidea. By A. E. Parr (out of print)..... pp. 1- 34 \$.50
 - ARTICLE 2. The stomiatoid fishes of the suborder Gymnophotodermi. By A. E. Parr (out of print)..... pp. 1-123 \$1.85
 - ARTICLE 3. Deepsea fishes of the order Iniomi from the waters around the Bahama and Bermuda Islands. By A. E. Parr (out of print)..... pp. 1-193 \$2.80

VOLUME III.—(Continued)

- ARTICLE 4. Teleostean shore and shallow-water fishes from the Bahamas and Turks Island. By A. E. Parr (out of print) . . . pp. 1-148 \$2.20
- ARTICLE 5. Deep sea eels, exclusive of larval forms. By A. E. Parr (out of print) . . . pp. 1- 41 \$.60
- ARTICLE 6. Deepsea Berycomorphi and Percomorphi from the waters around the Bahama and Bermuda Islands. By A. E. Parr (out of print) . . . pp. 1- 51 \$.75
- ARTICLE 7. Concluding report on fishes. By A. E. Parr. (out of print) pp. 1- 79 \$1.20

VOLUME IV. (Complete.)

- ARTICLE 1. A practical revision of the western Atlantic species of the genus *Citharichthys* (including *Etropus*). By A. E. Parr . . . pp. 1- 24 \$.35
- ARTICLE 2. A revision of the genus *Gobionellus* (family Gobiidae). By Isaac Ginsburg . . . pp. 1- 51 \$.75
- ARTICLE 3. A geographic-ecological analysis of the seasonal changes in temperature conditions in shallow water along the Atlantic coast of the United States. By A. E. Parr . . . pp. 1- 90 \$1.35
- ARTICLE 4. A contribution to the study of the natural food-cycle in aquatic environments. By R. M. Bond (out of print) . . pp. 1- 89 \$1.35
- ARTICLE 5. A revision of the genus *Gobiosoma* (Family Gobiidae). By Isaac Ginsburg (out of print) . . . pp. 1- 59 \$.90
- ARTICLE 6. Report on experimental use of a triangular trawl for bathypelagic collecting. By A. E. Parr (out of print) . . pp. 1- 59 \$.90
- ARTICLE 7. Littoral Penaeidea chiefly from the Bingham Oceanographic Collection. By M. D. Burkenroad (out of print) . . . pp. 1-109 \$1.65

VOLUME V. (Complete.)

- ARTICLE 1. Report on hydrographic observations in the Gulf of Mexico and the adjacent straits made during the Yale Oceanographic Expedition on the "Mabel Taylor" in 1932. By A. E. Parr (out of print) . . . pp. 1- 93 \$1.40
- ARTICLE 2. The Aristacinae, Solenocerinae and pelagic Penaeinae of the Bingham Oceanographic Collection. By M. D. Burkenroad (out of print) . . . pp. 1-151 \$2.25
- ARTICLE 3. Notes on Pennatulacea and Holothuriodea collected by the first and second Bingham Oceanographic Expeditions 1925-1926. By Elisabeth Deichmann (out of print) . . . pp. 1- 11 \$.15
- ARTICLE 4. A contribution to the hydrography of the Caribbean and Cayman Seas. By A. E. Parr (out of print) . . . pp. 1-110 \$1.65
- ARTICLE 5. Stomatopoda of the Bingham Oceanographic Collection. By G. R. Lunz . . . pp. 1- 19 \$.30

VOLUME VI. (Complete.)

- ARTICLE 1. A contribution to the chemistry of the Caribbean and Cayman Seas. By N. W. Rakestraw and H. P. Smith . . . pp. 1- 41 \$.60
- ARTICLE 2. On the longitudinal variations in the dynamic elevation of the surface of the Caribbean current. By A. E. Parr (out of print) . . . pp. 1- 20 \$.30

VOLUME VI.—(Continued)

- ARTICLE 3. Report on hydrographic observations at a series of anchor stations across the Straits of Florida. By A. E. Parr (out of print) . . . pp. 1- 62 \$.95
- ARTICLE 4. Further observations on the hydrography of the eastern Caribbean and adjacent Atlantic waters. By A. E. Parr (out of print) . . . pp. 1- 29 \$.45
- ARTICLE 5. A contribution to the life histories of Atlantic Ocean flying-fishes. By C. M. Breder, Jr. (out of print) . . . pp. 1-126 \$1.90
- ARTICLE 6. Further observations on Penaeidae of the northern Gulf of Mexico. By M. D. Burkenroad (out of print) . . . pp. 1- 62 \$.95
- ARTICLE 7. Quantitative observations on the pelagic sargassum vegetation of the western North Atlantic. By A. E. Parr . . . pp. 1- 94 \$1.40

VOLUME VII. (Complete.)

- ARTICLE 1. Acoel and polyclad Turbellaria from Bermuda and the Sargassum. By Libbie H. Hyman (out of print) . . . pp. 1- 26 \$.55
- ARTICLE 2. Young caranx in the western North Atlantic. By J. T. Nichols . . . pp. 1- 9 \$.15
- ARTICLE 3. Plankton Studies. III. Long Island Sound. By G. A. Riley pp. 1- 93 \$1.35
- ARTICLE 4. Plankton Studies. IV. Georges Bank. By G. A. Riley (out of print) . . . pp. 1- 73 \$1.10

VOLUME VIII. (Complete.)

- ARTICLE 1. A review of the types of polychaetous annelids at the Peabody Museum of Natural History, Yale University. By Olga Hartman . . . pp. 1- 98 \$1.50
- ARTICLE 2. A review of the American anchovies (Family Engraulidae). By S. F. Hildebrand (out of print) . . . pp. 1-165 \$2.50
- ARTICLE 3. The eggs of *Bathygobius soporator* (Cuvier and Valenciennes) with a discussion of other non-spherical teleost eggs. By C. M. Breder, Jr. (out of print) . . . pp. 1- 49 \$1.75
- ARTICLE 4. Physiological aspects of spring diatom flowering. By G. A. Riley . . . pp. 1- 53 \$.80

VOLUME IX. (Complete.)

- ARTICLE 1. Tetrodon poisoning. By W. H. Yudkin (out of print) . . pp. 1- 18 \$.30
- ARTICLE 2. Studies on the marine resources of southern New England. I. An analysis of the fish population of the shore zone. By H. E. Warfel and Daniel Merriman (out of print) . . pp. 1- 91 \$1.50
- ARTICLE 3. Studies on the marine resources of southern New England. III. The possibility of the utilization of the starfish (*Asterias forbesi* Desor). Composite Authorship . . . pp. 1- 58 \$.90
- ARTICLES 4 and 5. Studies on the marine resources of southern New England. IV. The biology and economic importance of the ocean pout, *Macrozoarces americanus* (Bloch and Schneider). By Y. H. Olsen and Daniel Merriman. V. Parasites and diseases of the ocean pout, *Macrozoarces americanus*. By R. F. Nigrelli . . . pp. 1-221 \$3.35

VOLUME X. (Complete.)

- ARTICLE 1. The Macrouridae of the western North Atlantic and Central American Seas. By A. E. Parr . . . pp. 1- 99 \$1.50

VOLUME X.—(Continued)

- ARTICLE 2. An analysis of the deceptive resemblances of fishes to plant parts, with critical remarks on protective coloration, mimicry and adaptation. By C. M. Breder, Jr. pp. 1- 49 \$.75
- ARTICLES 3 and 4. A systematic and ecological study of the Halacaridae of eastern North America. By I. M. Newell. Studies on the morphology and systematics of the family Halacaridae Oudemans 1906 (Acari, Parasitoidea). By I. M. Newell. pp. 1-266 \$4.00

VOLUME XI. (Complete.)

- ARTICLE 1. The deep-sea prawns of the family Oplophoridae in the Bingham Oceanographic Collection. By F. E. Chace, Jr. (out of print) pp. 1- 51 \$.75
- ARTICLE 2. The blackback flounder and its fishery in New England and New York. By Alfred Perlmutter (out of print) pp. 1- 92 \$1.40
- ARTICLE 3. Studies on the marine resources of southern New England. VI. The sand flounder, *Lophopsetta aquosa* (Mitchill); a general study of the species with special emphasis on age determination by means of scales and otoliths. By Emmeline Moore (out of print) pp. 1- 79 \$1.20
- ARTICLE 4. A symposium on fish populations. Composite Authorship. (out of print) pp. 1-283 \$4.25

VOLUME XII. (Complete.)

- ARTICLE 1. The zooplankton of Tisbury Great Pond. By Georgiana Baxter Deevey. pp. 1- 44 \$.65
- ARTICLE 2. The zooplankton of the upper waters of the Bermuda area of the North Atlantic. By Hilary B. Moore. pp. 1- 97 \$1.50
- ARTICLE 3. Quantitative ecology of the plankton of the western North Atlantic. By Gordon A. Riley, Henry Stommel and Dean F. Bumpus. pp. 1-169 \$2.50
- ARTICLE 4. The *Octopus bimaculatus* problem: a study in sibling species. By Grace E. Pickford and Bayard H. McConnaughey. pp. 1- 66 \$1.00

VOLUME XIII. (Complete.)

- ARTICLE 1. Oxygen, phosphate, and nitrate in the Atlantic Ocean. By Gordon A. Riley. pp. 1-126 \$1.90
- ARTICLE 2. Studies on the marine resources of southern New England. VIII. The biology of the Longhorn Sculpin, *Myoxocephalus octodecimspinosus* Mitchill, with a discussion of the southern New England "trash" fishery. By James E. Morrow. pp. 1- 89 \$1.35
- ARTICLE 3. Hydrographic and biological studies of Block Island Sound. By G. A. Riley, Georgiana B. Deevey, Daniel Merriman and Ruth Selar, and H. L. Sanders. pp. 1-237 \$3.60

VOLUME XIV. (Complete.)

- ARTICLE 1. The striped bass, *Roccus saxatilis*. By E. C. Raney, E. F. Tresselt, E. H. Hollis, and V. D. Vladikov and D. H. Wallace. pp. 1-177 \$3.00

VOLUME XIV.—(Continued)

- ARTICLE 2. Fish endocrinology: By Grace E. Pickford, S. L. Palay, Harriet A. Chambers, and Ethel H. Atz. pp. 1-116 \$1.75
- ARTICLE 3. The character and significance of sound production among fishes of the western North Atlantic. By Marie Poland Fish. pp. 1-109 \$1.65

VOLUME XV. (Complete.)

- Oceanography of Long Island Sound. By G. A. Riley, S. A. M. Conover, G. B. Deevey, R. J. Conover, S. B. Wheatland, Eugene Harris, and H. L. Sanders. pp. 1-414 \$7.50